

ASUS[®] P2B-VM
Pentium[®] II Motherboard

USER'S MANUAL

USER'S NOTICE

No part of this manual, including the products and software described in it, may be reproduced, transmitted, transcribed, stored in a retrieval system, or translated into any language in any form or by any means, except documentation kept by the purchaser for backup purposes, without the express written permission of ASUSTeK COMPUTER INC. ("ASUS").

ASUS PROVIDES THIS MANUAL "AS IS" WITHOUT WARRANTY OF ANY KIND, EITHER EXPRESS OR IMPLIED, INCLUDING BUT NOT LIMITED TO THE IMPLIED WARRANTIES OR CONDITIONS OF MERCHANTABILITY OR FITNESS FOR A PARTICULAR PURPOSE. IN NO EVENT SHALL ASUS, ITS DIRECTORS, OFFICERS, EMPLOYEES OR AGENTS BE LIABLE FOR ANY INDIRECT, SPECIAL, INCIDENTAL, OR CONSEQUENTIAL DAMAGES (INCLUDING DAMAGES FOR LOSS OF PROFITS, LOSS OF BUSINESS, LOSS OF USE OR DATA, INTERRUPTION OF BUSINESS AND THE LIKE), EVEN IF ASUS HAS BEEN ADVISED OF THE POSSIBILITY OF SUCH DAMAGES ARISING FROM ANY DEFECT OR ERROR IN THIS MANUAL OR PRODUCT.

Product warranty or service will not be extended if: (1) the product is repaired, modified or altered, unless such repair, modification or alteration is authorized in writing by ASUS; or (2) the serial number of the product is defaced or missing.

Products and corporate names appearing in this manual may or may not be registered trademarks or copyrights of their respective companies, and are used only for identification or explanation and to the owners' benefit, without intent to infringe.

- Intel, LANDesk, and Pentium are registered trademarks of Intel Corporation.
- IBM and OS/2 are registered trademarks of International Business Machines.
- Symbios is a registered trademark of Symbios Logic Corporation.
- Windows and MS-DOS are registered trademarks of Microsoft Corporation.
- Soft Synthesizer is a trademark of the Yamaha Corporation.
- Adobe and Acrobat are registered trademarks of Adobe Systems Incorporated.

The product name and revision number are both printed on the product itself. Manual revisions are released for each product design represented by the digit before and after the period of the manual revision number. Manual updates are represented by the third digit in the manual revision number.

For previous or updated manuals, BIOS, drivers, or product release information, contact ASUS at <http://www.asus.com.tw> or through any of the means indicated on the following page.

SPECIFICATIONS AND INFORMATION CONTAINED IN THIS MANUAL ARE FURNISHED FOR INFORMATIONAL USE ONLY, AND ARE SUBJECT TO CHANGE AT ANY TIME WITHOUT NOTICE, AND SHOULD NOT BE CONSTRUED AS A COMMITMENT BY ASUS. ASUS ASSUMES NO RESPONSIBILITY OR LIABILITY FOR ANY ERRORS OR INACCURACIES THAT MAY APPEAR IN THIS MANUAL, INCLUDING THE PRODUCTS AND SOFTWARE DESCRIBED IN IT.

Copyright © 1998 ASUSTeK COMPUTER INC. All Rights Reserved.

Product Name:	ASUS P2B-VM
Manual Revision:	1.03 E285
Release Date:	October 1998

ASUS CONTACT INFORMATION

ASUSTeK COMPUTER INC.

Marketing

Address: 150 Li-Te Road, Peitou, Taipei, Taiwan 112
Telephone: +886-2-2894-3447
Fax: +886-2-2894-3449
Email: info@asus.com.tw

Technical Support

Fax: +886-2-2895-9254
BBS: +886-2-2896-4667
Email: tsd@asus.com.tw
WWW: www.asus.com.tw
FTP: ftp.asus.com.tw/pub/ASUS

ASUS COMPUTER INTERNATIONAL

Marketing

Address: 6737 Mowry Avenue, Mowry Business Center, Building 2
Newark, CA 94560, USA
Fax: +1-510-608-4555
Email: info-usa@asus.com.tw

Technical Support

Fax: +1-510-608-4555
BBS: +1-510-739-3774
Email: tsd-usa@asus.com.tw
WWW: www.asus.com
FTP: ftp.asus.com.tw/pub/ASUS

ASUS COMPUTER GmbH

Marketing

Address: Harkort Str. 25, 40880 Ratingen, BRD, Germany
Telephone: 49-2102-445011
Fax: 49-2102-442066
Email: info-ger@asus.com.tw

Technical Support

Hotline: 49-2102-499712
BBS: 49-2102-448690
Email: tsd-ger@asus.com.tw
WWW: www.asuscom.de
FTP: ftp.asuscom.de/pub/ASUSCOM

CONTENTS

I. INTRODUCTION	7
How this manual is organized	7
Item Checklist	7
II. FEATURES	8
Features of the ASUS P2B-VM Motherboard	8
Parts of the ASUS P2B-VM Motherboard	11
III. INSTALLATION	12
ASUS P2B-VM Motherboard Layout	12
1. Jumpers	14
Installation Steps	14
2. System Memory (DIMM)	17
DIMM Memory Installation	18
3. Central Processing Unit (CPU)	19
Universal Retention Mechanism	19
Heatsinks	19
Installing the Processor	20
ASUS Smart Thermal Solutions	22
Recommended Heatsinks for Pentium II Processors	23
4. Expansion Cards	24
Expansion Card Installation Procedure	24
Assigning IRQs for Expansion Cards	24
Assigning DMA Channels for ISA Cards	25
5. External Connectors	26
Power Connection Procedures	35
IV. BIOS SOFTWARE	36
Flash Memory Writer Utility	36
Main Menu	36
Managing and Updating Your Motherboard's BIOS	38
6. BIOS Setup	39
Load Defaults	40
Standard CMOS Setup	40
Details of Standard CMOS Setup:	40
BIOS Features Setup	43
Details of BIOS Features Setup	43
Chipset Features Setup	46
Details of Chipset Features Setup	46
Power Management Setup	49
Details of Power Management Setup	49

CONTENTS

PNP and PCI Setup	52
Details of PNP and PCI Setup	52
Load BIOS Defaults	54
Load Setup Defaults	54
Supervisor Password and User Password	55
IDE HDD Auto Detection	56
Save & Exit Setup	57
Exit Without Saving	57
V. SUPPORT CD	58
ASUS Support CD Main Menu	58
A. Video Driver	61
B. Other Video Drivers	65
C. ATI Player	77
D. Audio Driver	81
E. Audio Software	85
F. DMI Utility	94

FCC & DOC COMPLIANCE

Federal Communications Commission Statement

This device complies with FCC Rules Part 15. Operation is subject to the following two conditions:

- This device may not cause harmful interference, and
- This device must accept any interference received, including interference that may cause undesired operation.

This equipment has been tested and found to comply with the limits for a Class B digital device, pursuant to Part 15 of the FCC Rules. These limits are designed to provide reasonable protection against harmful interference in a residential installation. This equipment generates, uses and can radiate radio frequency energy and, if not installed and used in accordance with manufacturer's instructions, may cause harmful interference to radio communications. However, there is no guarantee that interference will not occur in a particular installation. If this equipment does cause harmful interference to radio or television reception, which can be determined by turning the equipment off and on, the user is encouraged to try to correct the interference by one or more of the following measures:

- Re-orient or relocate the receiving antenna.
- Increase the separation between the equipment and receiver.
- Connect the equipment to an outlet on a circuit different from that to which the receiver is connected.
- Consult the dealer or an experienced radio/TV technician for help.

WARNING! The use of shielded cables for connection of the monitor to the graphics card is required to assure compliance with FCC regulations. Changes or modifications to this unit not expressly approved by the party responsible for compliance could void the user's authority to operate this equipment.

Canadian Department of Communications Statement

This digital apparatus does not exceed the Class B limits for radio noise emissions from digital apparatus set out in the Radio Interference Regulations of the Canadian Department of Communications.

I. INTRODUCTION

How this manual is organized

This manual is divided into the following sections:

- I. Introduction:** Manual information and checklist
- II. Features:** Information and specifications concerning this product
- III. Installation:** Instructions on setting up the motherboard
- IV. BIOS Software:** Instructions on setting up the BIOS software
- V. Support CD:** Information on the included support software

Item Checklist

Please check that your package is complete. If you discover damaged or missing items, please contact your retailer.

- (1) ASUS Motherboard
- (1) Pentium II retention mechanism
- (1) IDE ribbon cable for master and slave drives
- (1) Floppy ribbon cable for (1) 5.25inch floppy and (2) 3.5inch floppies
- (1) Bag of spare jumper caps
- (1) Support CD with drivers and utilities
- (1) Motherboard User's Manual

- COM2 connector with bracket (optional)
- COM2 + TV-Out connectors with bracket (optional)
- ASUS PC100 DIMM memory module (optional)
- ASUS PCI-L101 Wake-On-LAN 10/100 Fast Ethernet Card (optional)
- Infrared module (optional)

II. FEATURES

Features of the ASUS P2B-VM Motherboard

The ASUS P2B-VM is carefully designed for the demanding PC user who wants advanced features processed by the fastest CPU.

Specifications:

- **Multi-Speed:** Supports Intel Pentium® II (233MHz to 450MHz) and Celeron™ (266MHz and faster) processors.
- **Intel AGPset:** Features Intel's 440BX AGPset with I/O subsystems and front-side bus (FSB) platform, which boosts the traditional 66-MHz internal bus speed to 100MHz.
- **Multi-Cache:** Supports processors with either 0, 128, or 512KB Pipelined Burst Level 2 cache.
- **PC100 Memory Support:** Equipped with three DIMM sockets to support Intel PC100-compliant SDRAMs (8, 16, 32, 64, 128, or 256MB) up to 768MB. These new SDRAMs are necessary to meet the critical enhanced 100MHz bus speed requirement.
- **Peripheral Wake Up:** Supports modem wake up, keyboard wake up, and LAN card wake up functions from sleep or soft-off mode.
- **AGP 3D VGA:** Features optional onboard ATI 3D Rage Pro AGP 2X (8MB SDRAM) or Rage IIC AGP (4MB SDRAM) for 3D hardware acceleration.
- **AGP Slot (optional):** Supports AGP graphics cards for high performance, component level interconnect targeted at 3D graphical display applications. This slot is available as an option with the Rage IIC only.
- **PCI Audio (optional):** Features optional ESS 32-bit PCI audio onboard.
- **SB-Link™:** Features Creative's SB-Link™, allowing SB16 compatibility, using Intel's PC-PCI DMA and serialized IRQ protocols, to AWE64D or compatible PCI audio cards.
- **PCI & ISA Expansion Slots:** Provides one 16-bit ISA and three 32-bit PCI slots. The ISA slot is shared with a PCI slot.
- **Super Multi-I/O:** Provides two high-speed UART compatible serial ports and one parallel port with EPP and ECP capabilities. UART2 can also be directed from COM2 to the Infrared Module for wireless connections.
- **Ultra DMA/33 Bus Master IDE:** Comes with an onboard PCI Bus Master IDE controller with two connectors that support four IDE devices in two channels, supports UltraDMA/33, PIO Modes 3 and 4 and Bus Master IDE DMA Mode 2, and supports Enhanced IDE devices, such as Tape Backup and CD-ROM, and LS-120 drives.
- **Wake-On-LAN Header:** Supports Wake-On-LAN activity with special network cards, such as the ASUS PCI-L101 10/100 Fast Ethernet PCI card.

II. FEATURES

Special Features:

- **Enhanced ACPI and Anti-Boot Virus BIOS:** Features a programmable BIOS, offering enhanced ACPI for Windows 98 compatibility, built-in firmware-based virus protection through Trend ChipAway Virus codes, and autodetection of most devices for virtually automatic setup.
- **Desktop Management Interface (DMI):** Supports DMI through BIOS, which allows hardware to communicate within a standard protocol creating a higher level of compatibility. (Requires DMI-enabled components.)
- **Easy Installation:** Incorporates BIOS that supports autodetection of hard disk drives, PS/2 mouse, and Plug and Play devices to make the setup of hard disk drives, expansion cards, and other devices virtually automatic.
- **PC'98 Compliant:** Both the BIOS and hardware levels of ASUS smart series of motherboards meet PC'98 compliancy. The new PC'98 requirements for systems and components are based on the following high-level goals: Support for Plug and Play compatibility and power management for configuring and managing all system components, and 32-bit device drivers and installation procedures for Windows 95/98/NT.
- **Symbios SCSI BIOS:** Supports optional ASUS SCSI controller cards through onboard SYMBIOS firmware.

Performance Features:

- **Concurrent PCI:** Concurrent PCI allows multiple PCI transfers from PCI master busses to the memory and to the processor.
- **Double the IDE Transfer Speed:** ASUS smart series motherboards with Intel chipsets improves IDE transfer rate using Bus Master UltraDMA/33 IDE which can handle data transfer up to 33MB/s. The best of all is that this new technology is compatible with existing ATA-2 IDE specs so there is no need to upgrade current hard drives or cables.
- **SDRAM Optimized Performance:** Supports the new generation memory - Synchronous Dynamic Random Access Memory (SDRAM) which increases the data transfer rate from 528MB/s max using EDO memory to 800MB/s max using SDRAM.

II. FEATURES

Intelligent Features:

- **Auto Fan Off:** The system fans will power off automatically **even in sleep mode**. This function reduces both energy consumption *and* **system noise**, and is an important feature in implementing silent PC systems.
- **Dual Function Power Button:** Pushing the power button for less than 4 seconds when the system is in the working state places the system into one of two states: sleep mode or soft-off mode, depending on the BIOS setting (see “Power Management Setup” under **IV. BIOS SOFTWARE**). When the power button is pressed for more than 4 seconds, the system enters the soft-off mode regardless of the BIOS setting.
- **Keyboard Power Up:** Keyboard Power Up can be enabled or disabled to allow the computer to be powered on by pressing the space bar on the keyboard.
- **Message LED (requires ACPI OS support):** Turbo LEDs now act as information providers. Through the way a particular LED illuminates, the user can determine the stage the computer is in. A simple glimpse provides useful information to the user.
- **Remote Ring On (requires external modem):** This allows a computer to be turned on remotely through an external modem. With this benefit on-hand, any user can access vital information from their computer from anywhere in the world!
- **System Resources Alert:** Today’s operating systems such as Windows 95/98/NT and OS/2, require much more memory and hard drive space to present enormous user interfaces and run large applications. The system resource monitor will warn the user before the system resources are used up to prevent possible application crashes. Suggestions will give the user information on managing their limited resources more efficiently.

II. FEATURES

Parts of the ASUS P2B-VM Motherboard

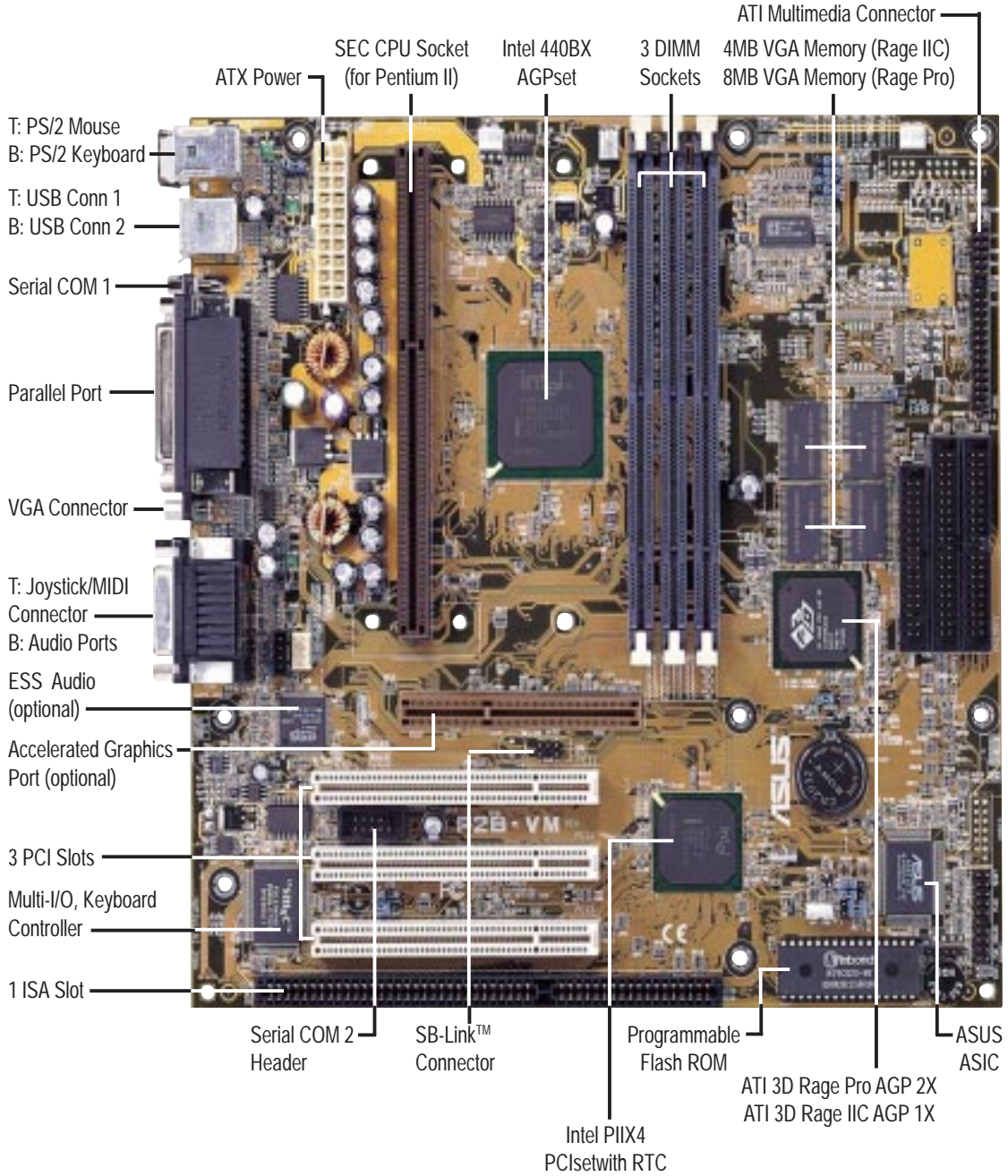

II. FEATURES
Motherboard Parts

III. INSTALLATION

ASUS P2B-VM Motherboard Layout

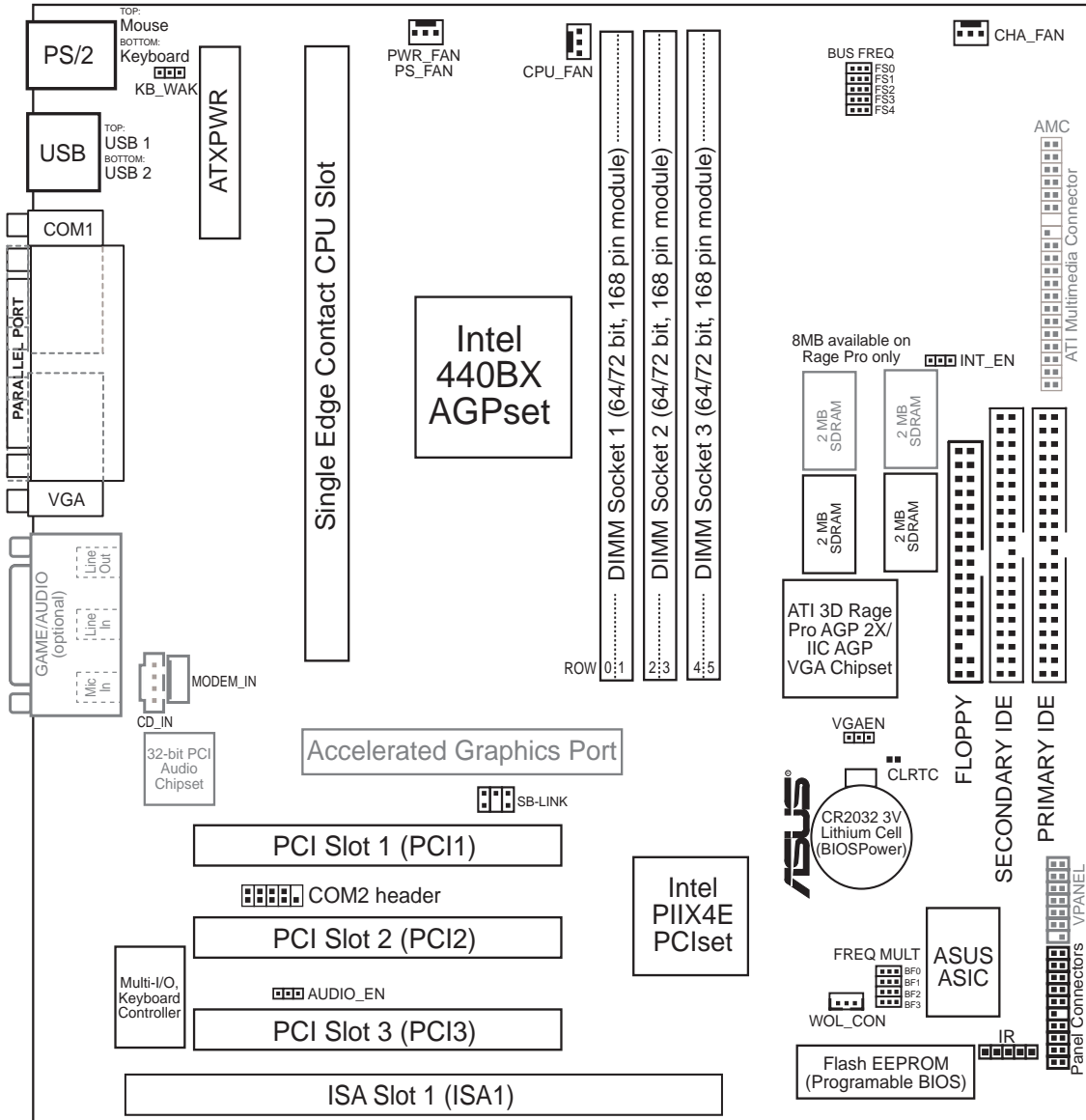

(Grayed items are optional at the time of purchase.)

III. INSTALLATION
Motherboard Layout

III. INSTALLATION

Jumpers

- | | |
|----------------------------|--|
| 1) INT_EN | p. 14 VGA Interrupt Setting (Enable/Disable) |
| 2) VGAEN | p. 14 VGA Setting (Enable/Disable) |
| 3) CLRTC | p. 15 Real Time Clock (RTC) RAM |
| 4) KB_WAK | p. 15 Keyboard Power (Wake) Up (Enable/Disable) |
| 5) FS0, FS1, FS2, FS3, FS4 | p. 16 CPU External Clock (BUS) Frequency Selection |
| 6) BF0, BF1, BF2, BF3 | p. 16 CPU:BUS Frequency Multiple |

Expansion Slots

- | | |
|---------------------|---------------------------------------|
| 1) DIMM Sockets | p. 17 168-Pin DIMM Memory Support |
| 2) SEC CPU Slot | p. 19 Single Edge Contact CPU Support |
| 3) PCI Slot 1, 2, 3 | p. 25 32-bit PCI Bus Expansion Slots |
| 4) ISA Slot 1 | p. 25 16-bit ISA Bus Expansion Slot |

Connectors

- | | |
|--------------------------|---|
| 1) MOUSE | P. 26 PS/2 Mouse Connector (6-pin female) |
| 2) KEYBOARD | p. 26 PS/2 Keyboard Connector (6-pin female) |
| 3) PRINTER | p. 27 Parallel Port Connector (25-pin female) |
| 4) COM1 | p. 27 Serial Port COM1 Connector (9-pin male) |
| 5) VGA | p. 27 Monitor (VGA) Output Connector (15-pin female) |
| 6) AUDIO (optional) | p. 28 Audio Port Connectors (Three 1/8" female) (optional) |
| 7) GAME (optional) | p. 28 Joystick/Midi Connector (15-pin female) (optional) |
| 8) USB | p. 28 Universal Serial BUS Ports 1 & 2 (Two 4-pin female) |
| 9) PRIMARY/SECONDARY IDE | p. 29 Primary/Secondary IDE Connectors (Two 40-1pins) |
| 10) FLOPPY | p. 29 Floppy Disk Drive Connector (34-1pins) |
| 11) IR | p. 30 IrDA-Compliant Infrared Module Connector (5 pins) |
| 12) WOL_CON | p. 30 Wake-On-LAN Connector (3 pins) |
| 13) CHA_, CPU_, PWR_FAN | p. 31 Chassis, CPU, Power Supply Fan Connectors (Three 3-pin) |
| 14) ATXPWR | p. 31 ATX Power Supply Connector (20 pins) |
| 15) SB-LINK | p. 32 SBLink Connector (6-1 pins) |
| 16) CD_IN, MODEM_IN | p. 32 Stereo Audio In and Modem Audio (Two 4-pin) |
| 17) MLED (PANEL) | p. 33 System Message LED (2 pins) |
| 18) KEYLOCK (PANEL) | p. 33 Keyboard Lock Switch Lead (2 pins) |
| 19) SMI (PANEL) | p. 33 SMI Switch Lead (2 pins) |
| 20) SPEAKER (PANEL) | p. 33 Speaker Output Connector (4 pins) |
| 21) PWR (PANEL) | p. 33 ATX Power & Soft-Off Switch Lead (2 pins) |
| 22) IDELED (PANEL) | p. 33 IDE Activity LED (2 pins) |
| 23) PLED (PANEL) | p. 33 System Power LED Lead (2 pins) |
| 24) RESET (PANEL) | p. 33 Reset Switch Lead (2 pins) |
| 25) COM2 | p. 34 Serial Port COM2 Header (10-1 pins) |
| 26) AMC | p. 34 ATI Multimedia Channel (40-3 pins) |

III. INSTALLATION

Installation Steps

Before using your computer, you must complete the following steps:

1. **Set Jumpers on the Motherboard**
2. **Install System Memory Modules**
3. **Install the Central Processing Unit (CPU)**
4. **Install Expansion Cards**
5. **Connect Ribbon Cables, Cabinet Wires, and Power Supply**
6. **Setup the BIOS Software**

WARNING! Computer motherboards, baseboards and components, such as SCSI cards, contain very delicate Integrated Circuit (IC) chips. To protect them against damage from static electricity, you should follow some precautions whenever you work on your computer.

1. Unplug your computer when working on the inside.
2. Use a grounded wrist strap before handling computer components. If you do not have one, touch both of your hands to a safely grounded object or to a metal object, such as the power supply case.
3. Hold components by the edges and try not to touch the IC chips, leads or connectors, or other components.
4. Place components on a grounded antistatic pad or on the bag that came with the component whenever the components are separated from the system.

1. Jumpers

1. VGA Interrupt Selection (INT_EN) and 2. VGA Setting (VGAEN)

The INT_EN jumper allows you to set the VGA interrupt method. The default disables the chipset's internal interrupt routing. Some TV-Tuner or MPEG cards may require that the interrupt be assigned by the onboard chipset, in which case enable INT_EN. The VGAEN jumper allows you to enable or disable the onboard VGA. Disable the onboard VGA if you are using a VGA card on the expansion slot.

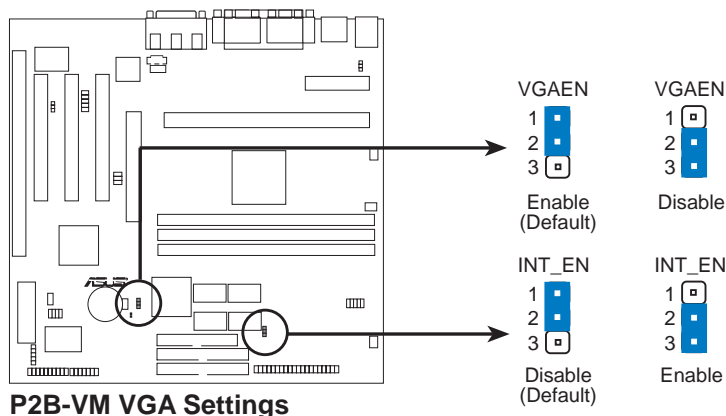

III. INSTALLATION

3. Real Time Clock (RTC) RAM (CLRTC)

The CMOS RAM is powered by the onboard button cell battery. To clear the RTC data: (1) Unplug your computer, (2) Short solder points, (3) Turn on your computer, (4) Hold down <Delete> during bootup and enter BIOS setup to re-enter user preferences.

RTC RAM CLRTC

Clear CMOS [short solder points momentarily]

4. Keyboard Power (Wake) Up (KB_WAK)

This allows you to disable or enable the keyboard power up function. Set this jumper to *Enable* if you wish to use your keyboard (by pressing the spacebar) to power up your computer. This feature requires an ATX power supply that can supply at least 300mA on the +5VSB lead. The default is set to *Disable* because not all computers have the appropriate ATX power supply. Your computer will not power on if you set this to *Enable* and if you do not have the right ATX power supply. **WARNING:** This jumper setting must coincide with the BIOS setting (see “Power Up By Keyboard” in the Power Management Setup of the BIOS SOFTWARE) or else conflicts will occur.

Setting KB WAK

Disable [1-2] (default)

Enable [2-3]

III. INSTALLATION

5. CPU Bus Frequency Selector (FS0, FS1, FS2, FS3, FS4)

This option tells the clock generator what frequency to send to the CPU, DRAM, and 440BX AGPset. This allows the selection of the CPU's *External* frequency (or *BUS Clock*). The BUS Clock multiplied by the BUS Ratio equals the CPU's *Internal* frequency (the advertised CPU speed).

6. CPU Core:BUS Frequency Multiple (BF0, BF1, BF2, BF3)

This option sets the frequency multiple between the *Internal* frequency of the CPU and the CPU's *External* frequency. These must be set in conjunction with the *CPU Bus Frequency*.

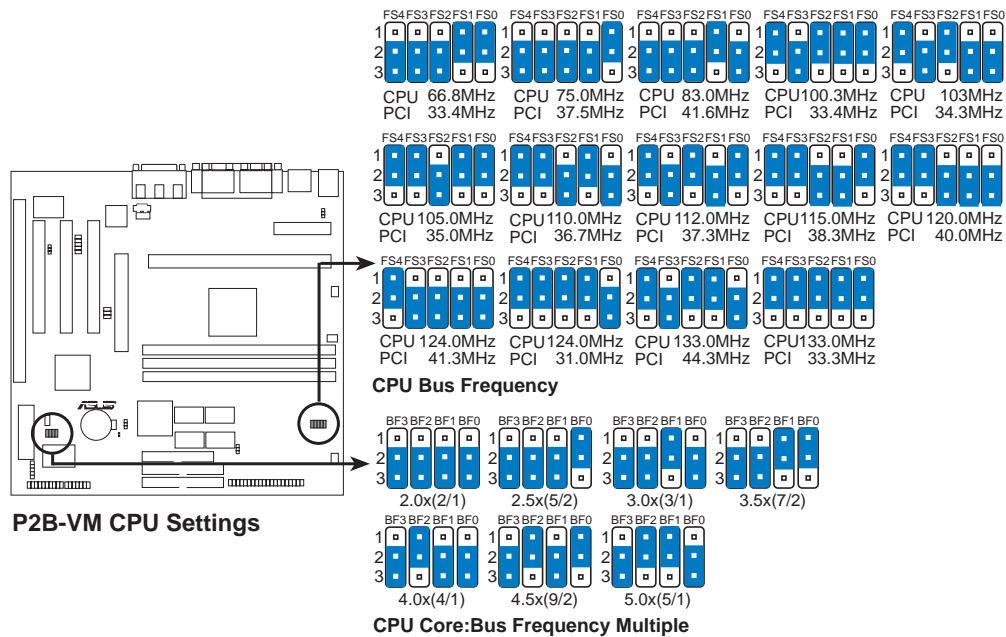

WARNING! Frequencies above 100MHz exceed the specifications for the on-board Intel Chipset and are not guaranteed to be stable.

WARNING! PCI frequencies above 33MHz exceed the specifications for PCI cards and are not guaranteed to be stable.

Set the jumpers by the Internal speed of your processor as follows:

CPU Model	Freq.	Ratio	BUS F.	(CPU BUS Freq.)					(Freq. Multiple)			
				FS4	FS3	FS2	FS1	FS0	BF3	BF2	BF1	BF0
Intel Pentium II	450MHz	4.5x	100MHz	[1-2]	[2-3]	[1-2]	[1-2]	[1-2]	[2-3]	[1-2]	[2-3]	[1-2]
Intel Pentium II	400MHz	4.0x	100MHz	[1-2]	[2-3]	[1-2]	[1-2]	[1-2]	[2-3]	[1-2]	[2-3]	[2-3]
Intel Pentium II	350MHz	3.5x	100MHz	[1-2]	[2-3]	[1-2]	[1-2]	[1-2]	[2-3]	[2-3]	[1-2]	[1-2]
Intel Pentium II	333MHz	5.0x	66MHz	[2-3]	[2-3]	[2-3]	[1-2]	[1-2]	[2-3]	[1-2]	[1-2]	[2-3]
Intel Pentium II	300MHz	4.5x	66MHz	[2-3]	[2-3]	[2-3]	[1-2]	[1-2]	[2-3]	[1-2]	[2-3]	[1-2]
Intel Pentium II	266MHz	4.0x	66MHz	[2-3]	[2-3]	[2-3]	[1-2]	[1-2]	[2-3]	[1-2]	[2-3]	[2-3]
Intel Pentium II	233MHz	3.5x	66MHz	[2-3]	[2-3]	[2-3]	[1-2]	[1-2]	[2-3]	[2-3]	[1-2]	[1-2]

NOTES: Overclocking your processor is not recommended. It may result in a slower speed. Voltage Regulator Output Selection (VID) is not needed for the Pentium II processor because it sends a VID signal directly to the onboard power controller.

III. INSTALLATION

2. System Memory (DIMM)

This motherboard uses only Dual Inline Memory Modules (DIMMs). Sockets are available for **3.3Volt** (power level) unbuffered Synchronous Dynamic Random Access Memory (SDRAM). One side (with memory chips) of the DIMM takes up one row on the motherboard.

To utilize the chipset's Error Checking and Correction (ECC) feature, you must use a DIMM module with 9 chips per side (standard 8 chips/side + 1 ECC chip) and make the proper settings through "Chipset Features Setup" in BIOS setup.

Memory speed setup is recommended through *SDRAM Configuration* under "Chipset Features Setup" in BIOS setup.

Install memory in any combination as follows:

DIMM Location	168-pin DIMM Size		Total Memory
Socket 1 (Rows 0&1)	SDRAM 8, 16, 32, 64, 128, 256MB	x1	
Socket 2 (Rows 2&3)	SDRAM 8, 16, 32, 64, 128, 256MB	x1	
Socket 3 (Rows 4&5)	SDRAM 8, 16, 32, 64, 128, 256MB	x1	
	Total System Memory (Max 768MB)	=	

General DIMM Notes

- **For the system CPU bus to operate at 100MHz, use only PC100-compliant DIMMs compatible with Intel's PC100 SDRAM specifications.** This motherboard operates at 100MHz, thus most systems will not even boot if non-compliant modules are used because of the strict timing issues involved under this speed. If your DIMMs are not PC100-compliant, set the CPU bus frequency to 66MHz.
- Two possible memory chips are supported: SDRAM with and without ECC.
- SDRAM chips are generally thinner with higher pin density than EDO (Extended Data Output) chips.
- BIOS shows SDRAM memory on bootup screen.
- 8 chips/side modules do not support ECC, only 9 chips/side modules support ECC.
- Single-sided DIMMs come in 16, 32, 64, 128MB; double-sided come in 32, 64, 128, 256MB.

III. INSTALLATION

DIMM Memory Installation

Insert the module(s) as shown. Because the number of pins are different on either side of the breaks, the module will only fit in the orientation as shown. DIMM modules are longer and have different pin contact on each side and therefore have a higher pin density. SIMM modules have the same pin contact on both sides.

The DIMMs must be **3.3V Unbuffered** for this motherboard. To determine the DIMM type, check the notches on the DIMMs (see figure below).

168-Pin DIMM Notch Key Definitions (3.3V)

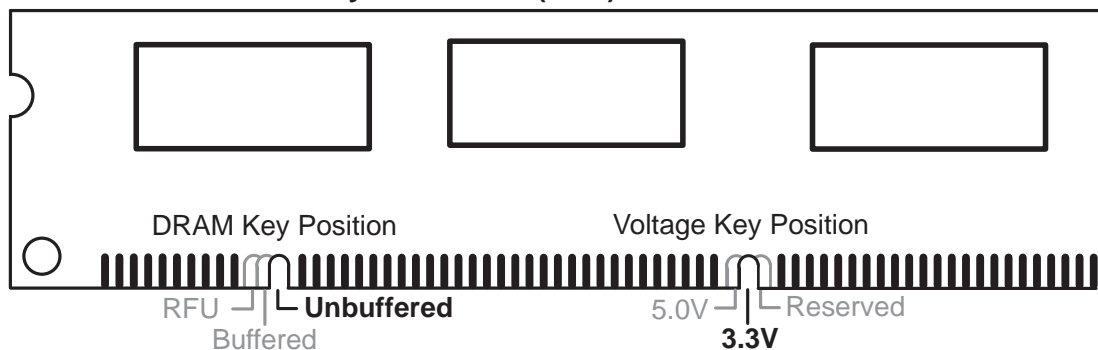

The notches on the DIMM module will shift between left, center, or right to identify the type and also to prevent the wrong type from being inserted into the DIMM slot on the motherboard. You must tell your retailer the correct DIMM type before purchasing. This motherboard supports four clock signals.

III. INSTALLATION

3. Central Processing Unit (CPU)

Your motherboard provides a Slot 1 connector for a Pentium® II processor packaged in a Single Edge Contact Cartridge (SECC/SECC2) or a Celeron™ processor packaged in a Single Edge Processor Package (SEPP).

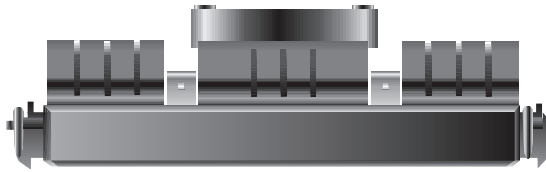

Pentium II processor packaged in an SECC with heatsink and fan (top view)

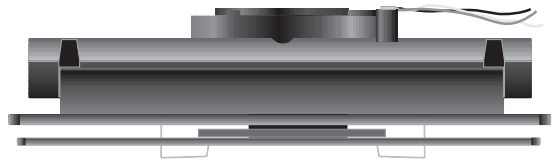

Pentium II processor packaged in an SECC2 or Celeron™ processor packaged in an SEPP with heatsink and fan (top view)

Universal Retention Mechanism

Your motherboard comes preinstalled with a Universal Retention Mechanism (URM). The URM supports Pentium II and Celeron processors.

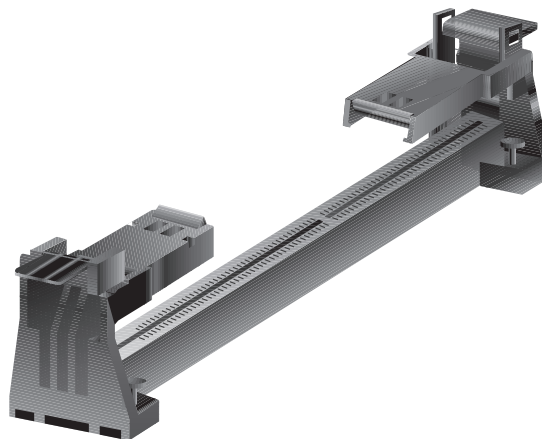

Universal Retention Mechanism (URM)

Heatsinks

The recommended heatsinks (see section on recommended heatsinks for Pentium II processors for more information) for the boxed Pentium II and Celeron processors are those with three-pin fans that can be connected to the fan connectors on the motherboard.

WARNING! Be sure that there is sufficient air circulation across the processor's heatsink by regularly checking that your CPU fan is working. Without sufficient circulation, the processor could overheat and damage both the processor and the motherboard. You may install an auxiliary fan, if necessary.

III. INSTALLATION

Installing the Processor

1. Unlock the URM's Folding Support Arms:

The folding support arms of the URM are locked when shipped.

To unlock the support arms, simply flip them up to an upright position.

The URM is now ready for the installation of your processor.

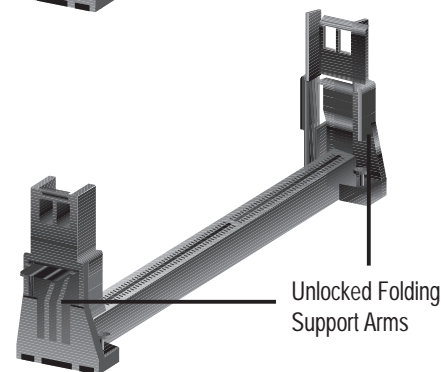
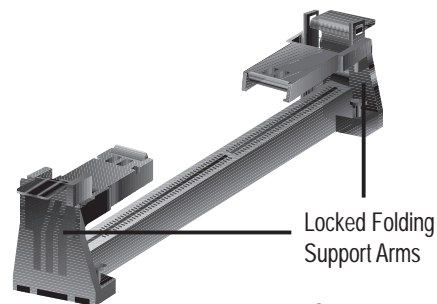

2. Attach the Heatsink

NOTE: Follow carefully the heatsink attachment instructions included with your heatsink or processor. The following steps are provided only as a general guide and may not reflect those for your heatsink.

SECC with Pentium® II

Place the SECC face down on a flat surface and lay the heat sink flush on the back (metal side) of the SECC. Check the orientation of the heatsink against the illustration below. The thicker fin must be orientated toward the bottom. The top clamp is wider than the bottom clamp so only this orientation will fit. With a screw driver, push the clamps one at a time into the SECC. Be sure that the heatsink is firmly pressed against the SECC.

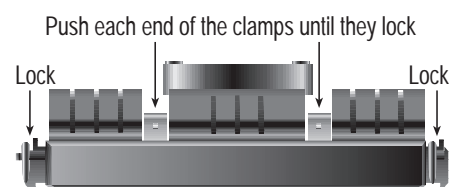

SECC2 with Pentium® II/SEPP with Celeron™

Insert the heatsink clip through the holes at the SECC2/SEPP's back, making sure that the bottom of the clip plate sits against the processor's back. Remove the tab from the thermal grease, which is located on the bottom of the heatsink) and place the heatsink over the processor. A slight rocking motion may be necessary to place the heatsink on the SECC2/SEPP, with one pair of the heatsink clip legs going first through the corresponding heatsink holes, and then the other pair. (**NOTE:** The heatsink and SECC2/SEPP holes are slightly offset to ensure good locking grip between the two.)



III. INSTALLATION

WARNING! Make sure the heatsink is mounted tightly against the SECC, SECC2 or SEPP; otherwise, the CPU will overheat. You may install an auxiliary fan to provide adequate circulation across the processor's passive heatsink.

3. Insert the SECC/SECC2/SEPP

SECC with Pentium® II only: Push the SECC's two locks inward until you hear a click (the picture in step 2 shows the locks in the outward position and inward in the picture below).

With the heatsink facing the motherboard's chipset, push the SECC, SECC2, or SEPP gently but firmly into the Slot 1 connector until it is fully inserted.

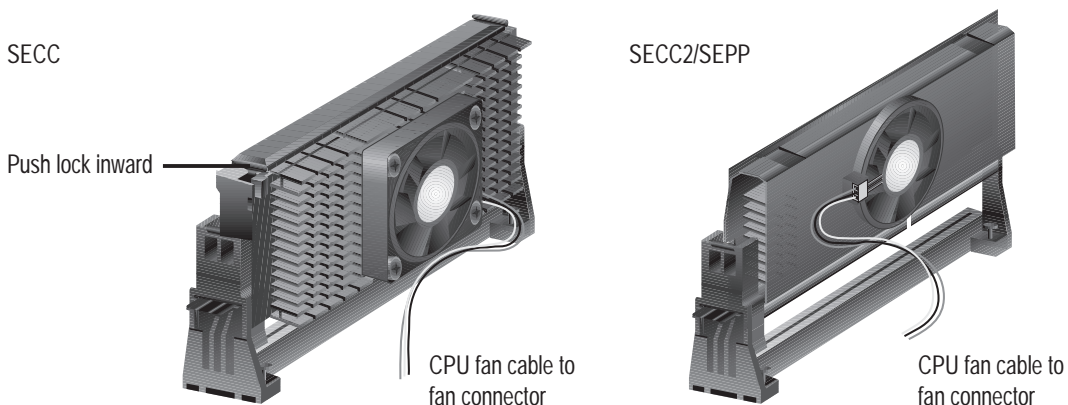

4. Secure the SECC/SECC2/SEPP

Secure the SECC/SECC2/SEPP in place by pushing the SECC/SECC2/SEPP until it is firmly seated on the Slot 1 connector.

SECC with Pentium® II only: The SECC locks should be outward when secured so that the lock shows through the retention mechanism's lock holes.

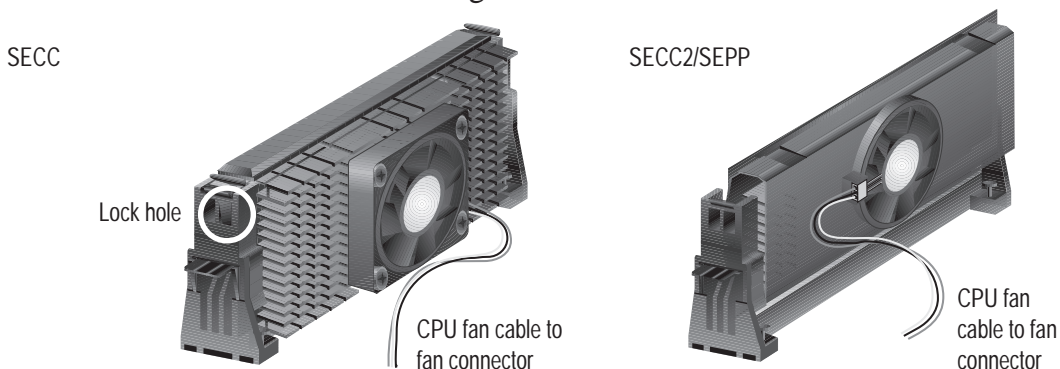

5. Attach the Thermal Sensor Cable (optional): If you purchased the especially designed ASUS Smart Fan (ASUS S-P2FAN), which comes with a thermal sensor built inside the CPU fan, or purchased separately the thermal sensor cable (ASUS P2T-Cable), you can connect the P2T-Cable to your motherboard's thermal sensor connector. (See next page for information on ASUS Smart Thermal Solutions.)

III. INSTALLATION

ASUS Smart Thermal Solutions

ASUS provides two smart solutions to Slot 1 CPU thermal problems: the ASUS Smart Fan or ASUS S-P2FAN and the ASUS P2T-Cable.

The **ASUS Smart Fan** or **ASUS S-P2FAN** is a CPU fan for a Pentium® II processor packaged in a Single Edge Contact Cartridge (SECC). Unlike other CPU thermal solutions, the ASUS S-P2FAN has an integrated thermal sensor located near the center of the CPU heat source. The sensor is optimized by ASUS to give the most accurate reading of the CPU temperature, thus provides the best protection to your computer system.

The **ASUS P2T-Cable** or thermal sensor cable can be used for a Pentium® II processor packaged in a Single Edge Contact Cartridge (SECC/SECC2) or a Celeron™ processor packaged in a Single Edge Processor Package (SEPP).

To use the ASUS S-P2FAN: See **2. Attach the Heatsink** on the preceding page for the relevant procedures. Note that the S-P2FAN comes with a rock arm design for easy FAN/CPU installation.

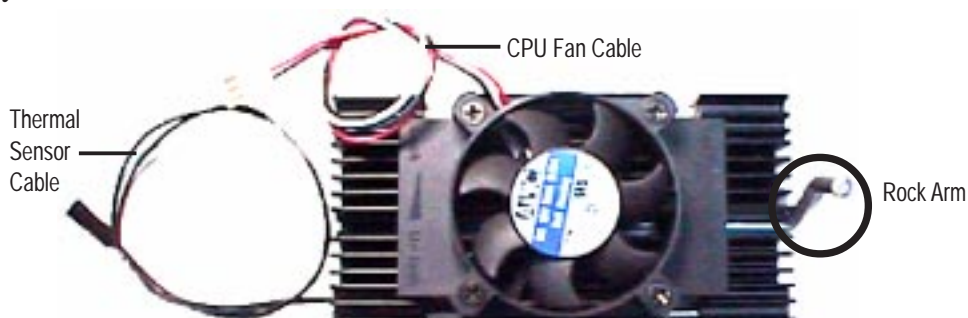

NOTE: The ASUS S-P2FAN can only be used for Intel's boxed processors.

To use the ASUS P2T-Cable:

1. Simply peel off the tab from the sensor and then stick the sensor to the lower edge of the Intel boxed processor heatsink with fan or to the upper edge of the Celeron™ heatsink, as indicated in the pictures below.

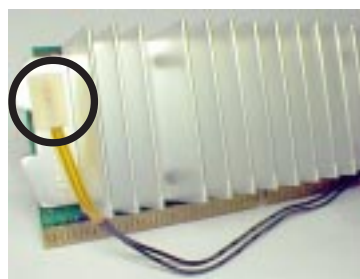

III. INSTALLATION

Recommended Heatsinks for Pentium II Processors

The heatsinks shown in this manual are for reference purposes only. The recommended heatsinks for the Pentium II processor are those with three-pin fans that can be connected to the CPU fan connector on the motherboard. These heatsinks have the added benefits of proper heat dissipation and with the hardware monitor, the ability to monitor the fan's RPM and use the alert function through the included LANDesk Client Manager (LDCM) software.

AAVID Heatsink



The procedures for installing the Aavid heatsink with fan is similar to the preceding procedure. You will not, however, be able to use the heatsink support top bar because of the fan. The heatsink support top bar will, however, still be included in the package, in case you use a heatsink without a fan.

Elan Vital Heatsink



The procedures for installing the Elan Vital heatsink with fan is also similar to the preceding procedure. The Elan Vital heatsink, however, comes with a lever to clamp the heatsink into the SEC cartridge. Mount the heatsink in the orientation as shown then flip the lever from “Unlock” to “Lock.” You will not be able to simultaneously use the heatsink support top bar because of the fan. The heatsink support top bar will, however, still be included in the package, in case you use a heatsink without a fan.

III. INSTALLATION

4. Expansion Cards

WARNING! Unplug your power supply when adding or removing expansion cards or other system components. Failure to do so may cause severe damage to both your motherboard and expansion cards.

Expansion Card Installation Procedure

1. Read the documentation for your expansion card and make any necessary hardware or software settings for your expansion card, such as jumpers.
2. Remove your computer system's cover and the bracket plate on the slot you intend to use. Keep the bracket for possible future use.
3. Carefully align the card's connectors and press firmly.
4. Secure the card on the slot with the screw you removed above.
5. Replace the computer system's cover.
6. Set up the BIOS if necessary
(such as *IRQ xx Used By ISA: Yes* in PNP AND PCI SETUP)
7. Install the necessary software drivers for your expansion card.

Assigning IRQs for Expansion Cards

Some expansion cards need to use an IRQ to operate. Generally, an IRQ must be exclusively assigned to one use. In a standard design, there are 16 IRQs available but most of them are already in use, leaving 6 IRQs free for expansion cards. If your motherboard has audio onboard, an extra 3 IRQs will be used, leaving 3 IRQs free.

Both ISA and PCI expansion cards may require to use IRQs. System IRQs are available to cards installed in the ISA expansion bus first, then any remaining IRQs are available to PCI cards. Currently, there are two types of ISA cards. The original ISA expansion card design, now referred to as legacy ISA cards, requires that you configure the card's jumpers manually and then install it in any available slot on the ISA bus. You may use the Microsoft Diagnostics (MSD.EXE) utility located in the Windows directory to see a map of your used and free IRQs. If you use Windows 95, the **Resources** tab under **Device Manager** displays the resource settings being used by a particular device (to gain access, double-click the **System** icon under the **Control Panel** program). Ensure that no two devices share the same IRQs or your computer will experience problems when those two devices are in use at the same time.

III. INSTALLATION

To simplify this process, this motherboard has complied with the Plug and Play (PNP) specification which was developed to allow automatic system configuration whenever a PNP-compliant card is added to the system. For PNP cards, IRQs are assigned automatically from those available.

If the system has both Legacy and PNP ISA cards installed, IRQs are assigned to PNP cards from those not used by Legacy cards. The PCI and PNP configuration of the BIOS setup utility can be used to indicate which IRQs are being used by Legacy cards. For older Legacy cards that do not work with the BIOS, you can contact your vendor for an ISA Configuration Utility.

An IRQ number is automatically assigned to PCI expansion cards after those used by Legacy and PNP ISA cards. In the PCI bus design, the BIOS automatically assigns an IRQ to a PCI slot that has a card in it that requires an IRQ. To install a PCI card, you need to set something called the INT (interrupt) assignment. Since all the PCI slots on this motherboard use an INTA #, be sure that the jumpers on your PCI cards are set to INT A.

Assigning DMA Channels for ISA Cards

Some ISA cards, both legacy and PnP, may also need to use a DMA (Direct Memory Access) channel. DMA assignments for this motherboard are handled the same way as the IRQ assignment process described earlier. You can select a DMA channel in the PCI and PnP configuration section of the BIOS Setup utility.

IMPORTANT: To avoid conflicts, reserve the necessary IRQs and DMAs for legacy ISA cards (under PNP AND PCI SETUP of the BIOS SOFTWARE, choose *Yes* in *IRQ xx Used By ISA* and *DMA x Used By ISA* for those IRQs and DMAs you want to reserve).

Accelerated Graphics Port (optional)

This motherboard provides an accelerated graphics port (AGP) slot to support a new generation of graphics cards with ultra-high memory bandwidth, such as an ASUS 3D Hardware Accelerator. **NOTE:** You must set the VGAEN jumper to *Disable* when using an external AGP card in order to disable the onboard AGP chipset.

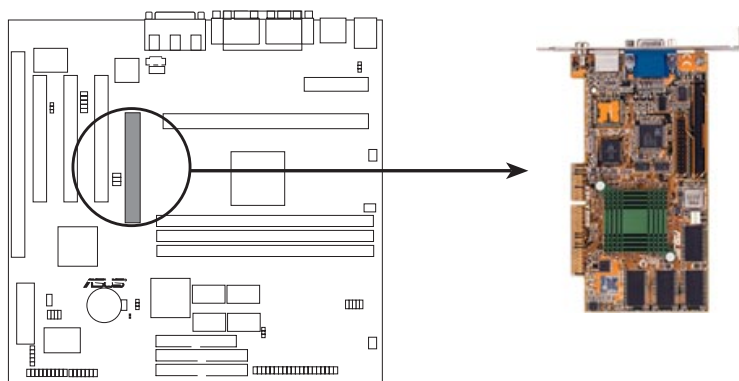

P2B-VM Accelerated Graphics Port (AGP)

III. INSTALLATION

5. External Connectors

WARNING! Some pins are used for connectors or power sources. These are clearly distinguished from jumpers in the Motherboard Layout. Placing jumper caps over these connector pins will cause damage to your motherboard.

IMPORTANT: Ribbon cables should always be connected with the red stripe on the Pin 1 side of the connector. The four corners of the connectors are labeled on the motherboard. Pin 1 is the side closest to the power connector on hard drives and floppy drives. IDE ribbon cable must be less than 46cm(18in.), with the second drive connector no more than 15cm (6in.) from the first connector.

1. PS/2 Mouse Connector (6-pin Female)

The system will direct IRQ12 to the PS/2 mouse if one is detected. If not detected, expansion cards can use IRQ12. See “PS/2 Mouse Control” in BIOS Features Setup of the BIOS SOFTWARE.

PS/2 Mouse (6-pin Female)

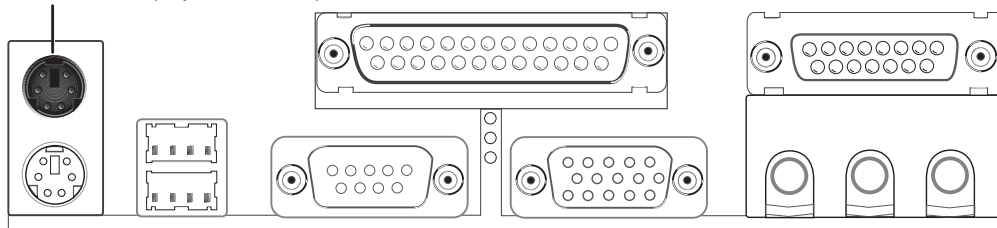

2. PS/2 Keyboard Connector (6-pin Female)

This connection is for a standard keyboard using a PS/2 plug (mini DIN). **This connector will not allow standard AT size (large DIN) keyboard plugs. You may use a DIN to mini DIN adapter on standard AT keyboards.**

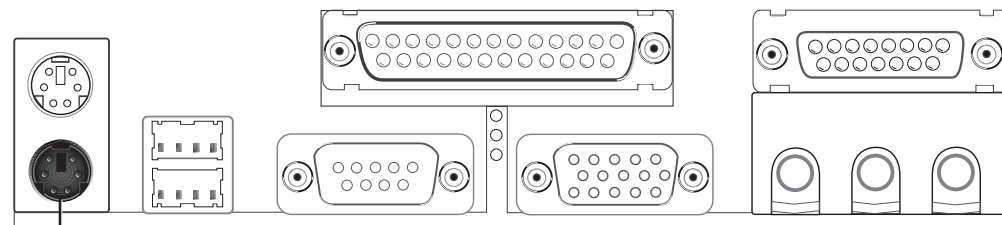

PS/2 Keyboard (6-pin Female)

III. INSTALLATION

3. Parallel Port Connector (25-pin Female)

You can enable the parallel port and choose the IRQ through “Onboard Parallel Port” in Chipset Features Setup of the BIOS SOFTWARE.

NOTE: Serial printers must be connected to the serial port.

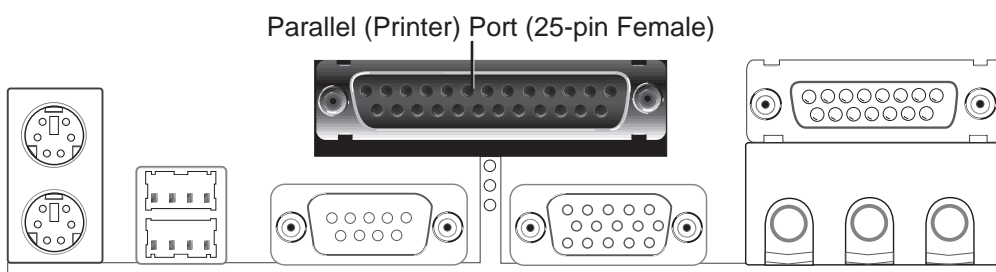

4. Serial Port COM1 Connector (9-pin Male)

One serial port is ready for a mouse or other serial devices. A second serial port is available using a serial port bracket connected from the motherboard to an expansion slot opening. See “Onboard Serial Port” in Chipset Features Setup of the BIOS SOFTWARE for settings.

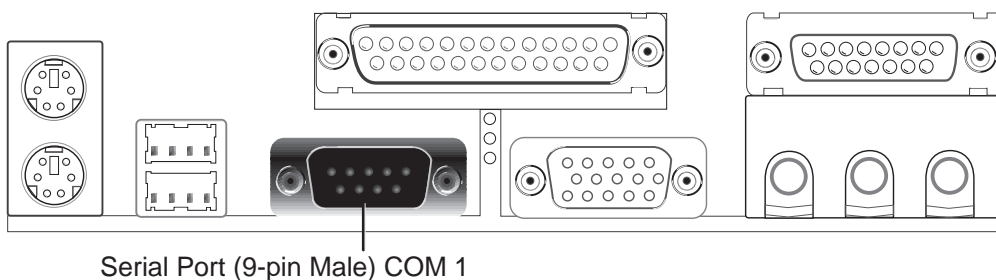

5. Monitor (VGA) Output Connector (15-pin Female)

This connector is for output to a VGA-compatible device.

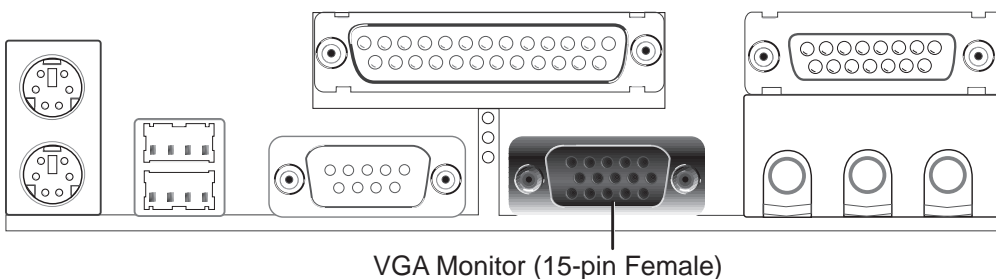

III. INSTALLATION

6. **Audio Port Connectors (Three 1/8" Female)** (with optional onboard audio)
Line Out can be connected to headphones or preferably powered speakers. **Line In** allows tape players or other audio sources to be recorded by your computer or played through the **Line Out**. **Mic** allows microphones to be connected for inputting voice.

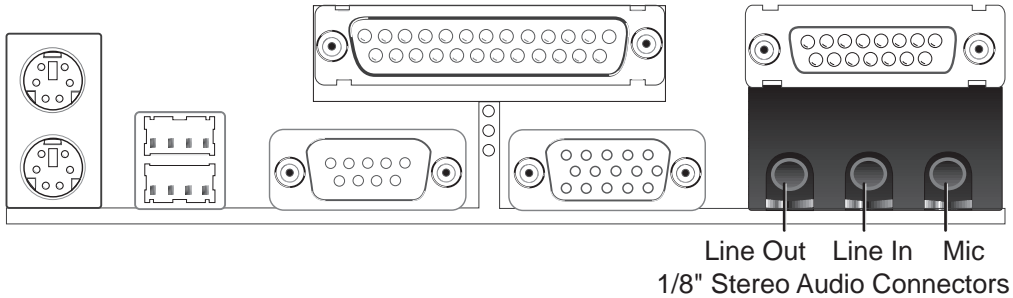

7. **Joystick/Midi Connector (15-pin Female)** (with optional onboard audio)
You may connect game joysticks or game pads to this connector for playing games. Connect Midi devices for playing or editing audio.

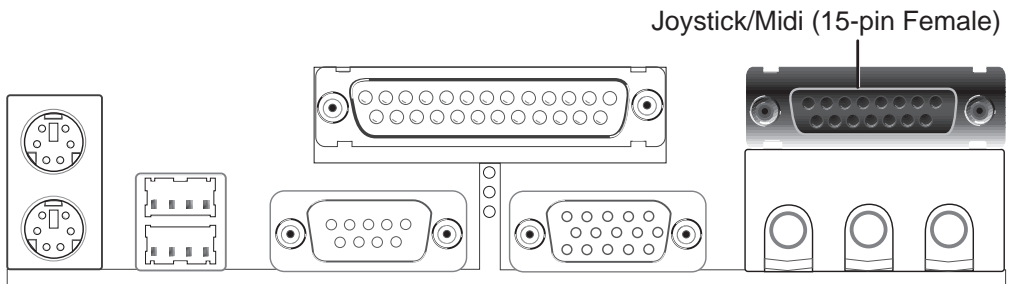

8. **Universal Serial BUS Ports 1 & 2 (Two 4-pin Female)**
Two USB ports are available for connecting USB devices.

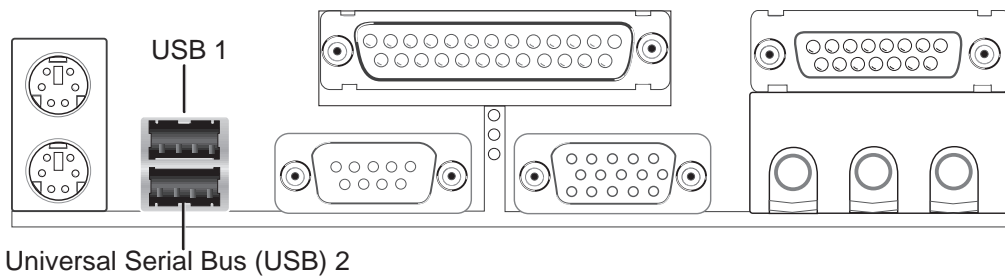

III. INSTALLATION

9. Primary / Secondary IDE connectors (Two 40-1pin IDE)

These connectors support the provided IDE hard disk ribbon cable. After connecting the single end to the board, connect the two plugs at the other end to your hard disk(s). If you install two hard disks, you must configure the second drive to Slave mode by setting its jumper accordingly. Please refer to the documentation of your hard disk for the jumper settings. BIOS now supports SCSI device or IDE CD-ROM bootup (see “HDD Sequence SCSI/IDE First” & “Boot Sequence” in the **BIOS Features Setup** of the BIOS SOFTWARE) (**Pin 20 is removed to prevent inserting in the wrong orientation when using ribbon cables with pin 20 plugged**).

TIP: You may configure two hard disks to be both Masters using one ribbon cable on the primary IDE connector and another ribbon cable on the secondary IDE connector. You may install one operating system on an IDE drive and another on a SCSI drive and select the boot disk through BIOS Features Setup.

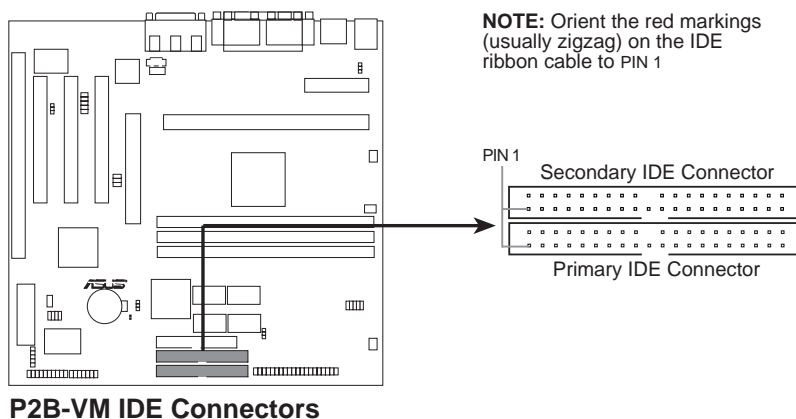

P2B-VM IDE Connectors

10. Floppy Disk Drive Connector (34-1pin FLOPPY)

This connector supports the provided floppy drive ribbon cable. After connecting the single end to the board, connect the two plugs on the other end to the floppy drives. (**Pin 5 is removed to prevent inserting in the wrong orientation when using ribbon cables with pin 5 plugged**).

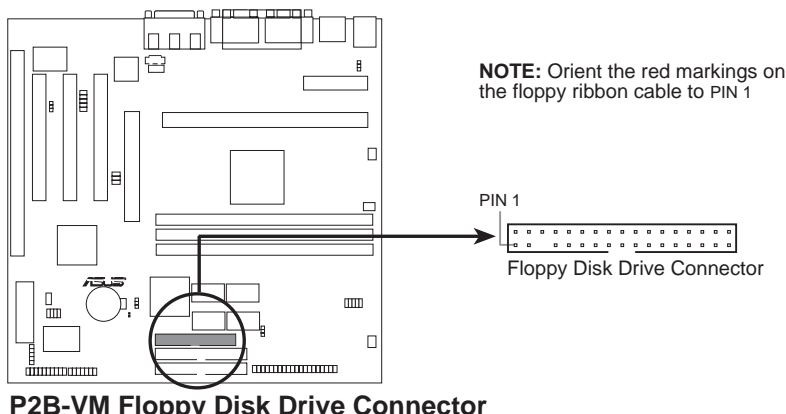

P2B-VM Floppy Disk Drive Connector

III. INSTALLATION

11. IrDA-Compliant infrared module connector (5-pin IR)

This connector supports the optional wireless transmitting and receiving infrared module. This module mounts to a small opening on system cases that support this feature. You must also configure the setting through “UART2 Use Infrared” in **Chipset Features Setup** to select whether UART2 is directed for use with COM2 or IrDA. Use the five pins as shown on the Back View and connect a ribbon cable from the module to the motherboard according to the pin definitions.

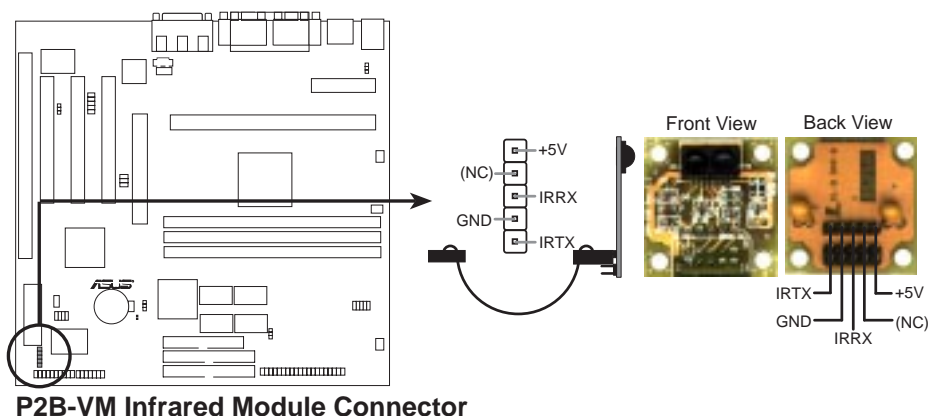

12. Wake-On-LAN Connector (3-pin WOL_CON)

This connector connects to LAN cards with a Wake On LAN output, such as the ASUS PCI-L101. The connector powers up the system when a wakeup packet or signal is received through the LAN card.

IMPORTANT: This feature requires that the **WAKE On LAN Power Up Control** is set to *Enabled* (see “Power Management Setup” under **BIOS SOFTWARE** section) and that your system has an ATX power supply with at least 720mA +5V standby power.

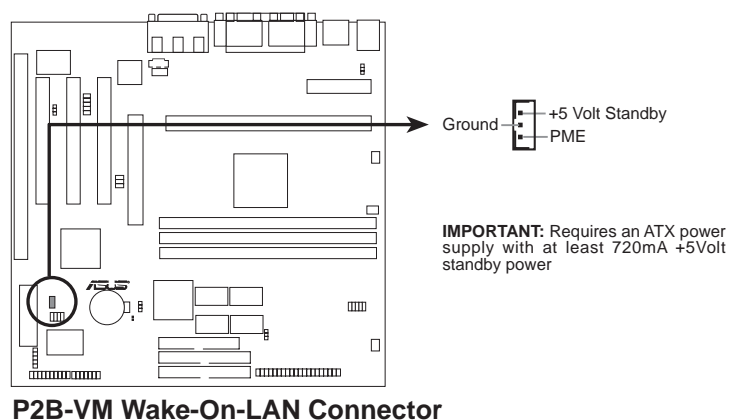

III. INSTALLATION

13. Chassis, CPU, & Power Supply Fan Connectors (3-pin CHA_, CPU_, PWR_FAN)

These connectors support cooling fans of 500mAMP (6 Watts) or less. Orientate the fans so that the heat sink fins allow airflow to go across the onboard heat sink(s) instead of the expansion slots. Depending on the fan manufacturer, the wiring and plug may be different. The red wire should be positive, while the black should be ground. Connect the fan's plug to the board taking into consideration the polarity of the this connector. **NOTE: The "Rotation" signal is to be used only by a specially designed fan with rotation signal.**

WARNING! The CPU and/or motherboard will overheat if there is no airflow across the CPU and onboard heatsinks. Damage may occur to the motherboard and/or the CPU fan if these pins are incorrectly used. **These are not jumpers, do not place jumper caps over these pins.**

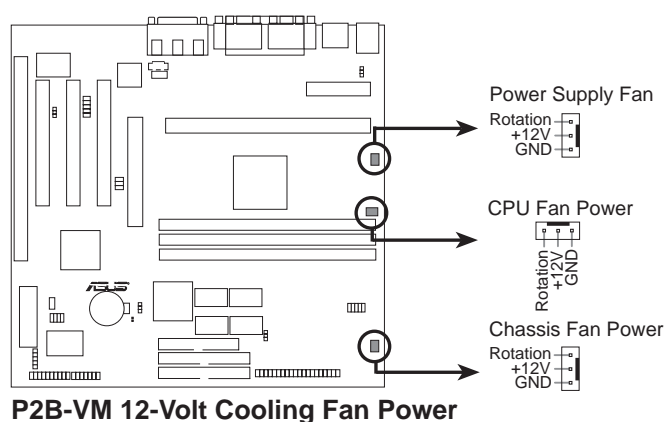

14. ATX Power Supply Connector (20-pin block ATXPWR)

This connector connects to an ATX power supply. The plug from the power supply will only insert in one orientation because of the different hole sizes. Find the proper orientation and push down firmly making sure that the pins are aligned.

IMPORTANT: Make sure that your ATX power supply can supply at least 10mA on the 5-volt standby lead (5VSB). You may experience difficulty in powering on your system if your power supply cannot support the load. For Wake-On-LAN support, your ATX power supply must supply at least 720mA +5VSB.

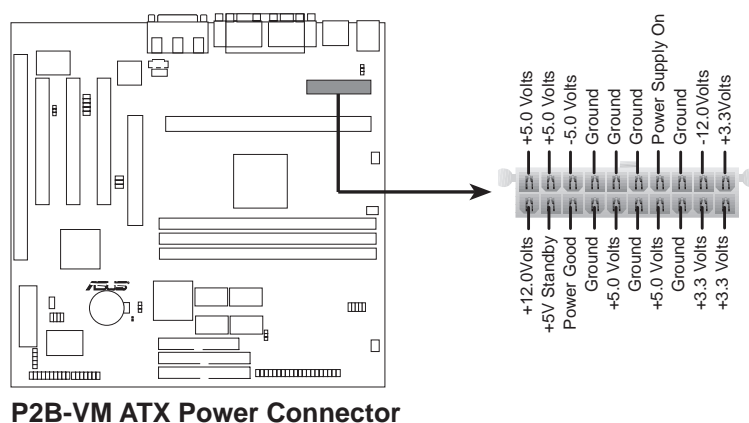

III. INSTALLATION

15. SB-Link™ Connector (6-1 pin SBLINK)

Using Intel's PC-PCI and serialized IRQ protocols found in this motherboard's AGPset, this connector allows Sound Blaster 16 compatibility to AWE64D (Digital) or other PCI audio cards, enabling users to play Real-mode DOS games and multimedia applications. SB-Link acts as a bridge between the motherboard and the PCI audio card by providing the DMA and IRQ signals present in the ISA bus but not available on the PCI bus.

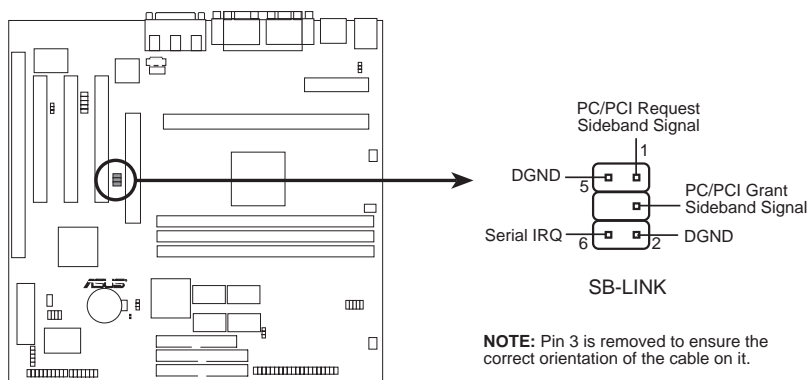

P2B-VM SB-Link™ Connector

16. Stereo Audio In Connector (4-pin)/Voice Modem In Connector (4-pin)

The CD_IN connector can be used to receive stereo audio input from an internal CD-ROM drive or other sound sources such as a TV tuner or MPEG card. The MODEM_IN connector allows mono input and output for a voice modem microphone and speaker interface.

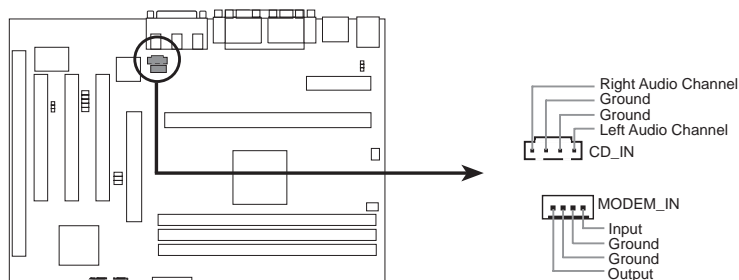

P2B-VM Stereo Audio In and Voice Modem In Connectors

III. INSTALLATION

17. Message LED Lead (2-pin MLED)

This indicates whether a message has been received from a fax/modem. The LED will remain lit when there is no signal and blink when data are being transfer or messages are waiting in the inbox. This function requires ACPI OS support.

18. Keyboard Lock Switch Lead (2-pin KEYLOCK)

This 2-pin connector connects to the case-mounted key switch to allow keyboard locking.

19. System Management Interrupt Lead (2-pin SMI)

This allows the user to manually place the system into a suspend mode or “Green” mode where system activity will be instantly decreased to save electricity and expand the life of certain components when the system is not in use. This 2-pin connector (see the figure below) connects to the case-mounted suspend switch. If you do not have a switch for the connector, you may use the “Turbo Switch” since it does not have a function. SMI is activated when it detects a *short to open* moment and therefore leaving it shorted will not cause any problems. May require one or two pushes depending on the position of the switch. Wake-up can be controlled by settings in the BIOS but the keyboard will always allow wake-up (the SMI lead cannot wake-up the system). If you want to use this connector, “Suspend Switch” in the **Power Management Setup** of the BIOS SOFTWARE section should be on the default setting of *Enable*.

20. Speaker Connector (4-pin SPEAKER)

This 4-pin connector connects to the case-mounted speaker.

21. ATX Power Switch/Soft Power Switch (2-pin PWR)

The system power is controlled by a momentary switch connected to this lead. Pushing the button once will switch the system between ON and SLEEP. Pushing the switch while in the ON mode for more than 4 seconds will turn the system off. The system power LED shows the status of the system’s power.

22. IDE Activity LED (2-pin IDELED)

This 2-pin connector supplies power to the cabinet’s IDE activity LED. Read and write activity by devices connected to the Primary or Secondary IDE connectors will cause the LED to light up.

23. System Power LED (2-pin PLED)

This 3-pin connector connects the system power LED, which lights when the system is powered on and blinks when it is in sleep mode.

24. Reset Switch Lead (2-pin RESET)

This 2-pin connector connects to the case-mounted reset switch for rebooting your computer without having to turn off your power switch. This is a preferred method of rebooting to prolong the life of the system’s power supply.

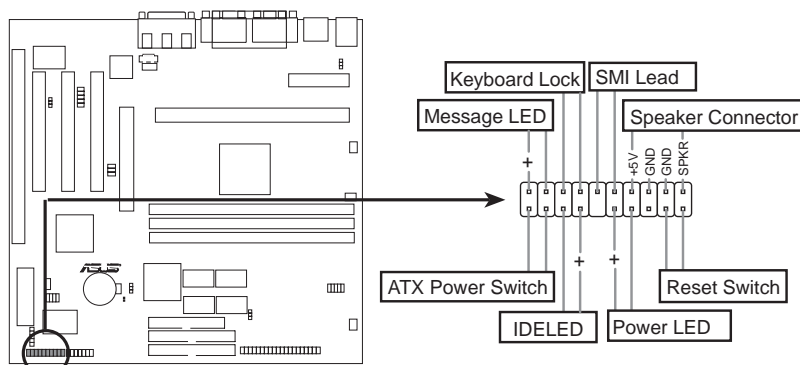

P2B-VM System Panel Connectors

III. INSTALLATION

25. Serial Port COM 2 (10-1 pin COM2)

The optional serial port bracket can be used to add an additional serial port for additional serial devices.

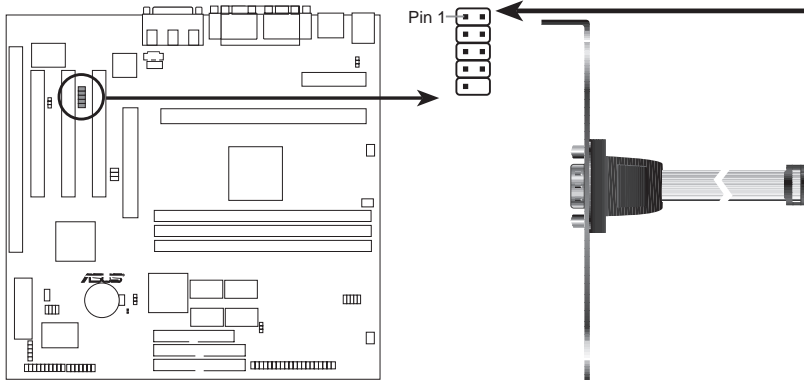

P2B-VM Serial COM 2 Bracket

26. ATI Multimedia Channel AMC (40-3 pin AMC)

This connector is used for video accessories such as video capture cards or television tuners.

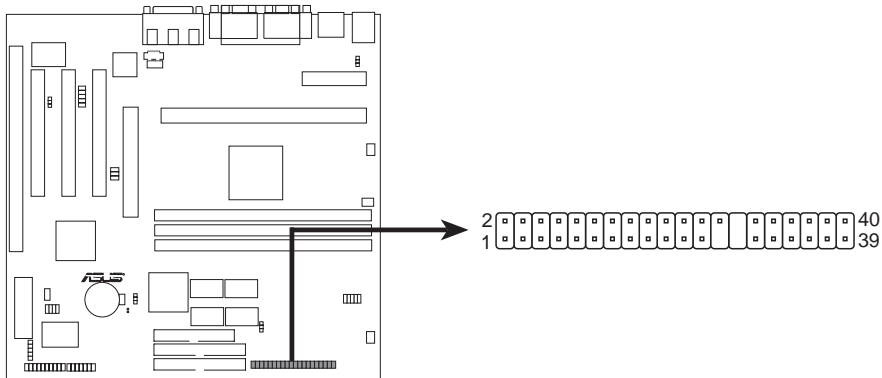

P2B-VM ATI Multimedia Channel Connector

III. INSTALLATION

Power Connection Procedures

1. After all connections are made, close the system case cover.
 2. Be sure that all switches are off (in some systems, marked with ○).
 3. Connect the power supply cord into the power supply located on the back of your system case according to your system user's manual.
 4. Connect the power cord into a power outlet that is equipped with a surge protector.
 5. You may then turn on your devices in the following order:
 - a. Your monitor
 - b. External SCSI devices (starting with the last device on the chain)
 - c. Your system power. For ATX power supplies, you need to switch on the power supply as well as press the ATX power switch on the front of the case.
 6. The power LED on the front panel of the system case will light. For ATX power supplies, the system LED will light when the ATX power switch is pressed. The monitor LED may light up after the system's if it complies with "green" standards or if it has a power standby feature. The system will then run power-on tests. While the tests are running, additional messages will appear on the screen. If you do not see anything within 30 seconds from the time you turn on the power, the system may have failed a power-on test. Recheck your jumper settings and connections or call your retailer for assistance.
 7. During power-on, hold down <Delete> to enter BIOS setup. Follow the instructions in the next section, BIOS SOFTWARE.
- * **Powering Off your computer:** You must first exit or shut down your operating system before switching off the power switch. For ATX power supplies, you can press the ATX power switch after exiting or shutting down your operating system. If you use Windows 95, click the **Start** button, click **Shut Down**, and then click **Shut down the computer?**

NOTE: The message "You can now safely turn off your computer" will not appear when shutting down with ATX power supplies.

IV. BIOS SOFTWARE

Flash Memory Writer Utility

AFLASH.EXE: This is the Flash Memory Writer utility that updates the BIOS by uploading a new BIOS file to the programmable flash ROM chip on the motherboard. To determine the BIOS version of your motherboard, check the last four numbers of the code displayed on the upper left-hand corner of your screen during bootup. Larger numbers represent a newer BIOS file. This file works only in DOS mode.

NOTE: The following screen displays are provided as examples only and may not reflect the screen contents displayed on your system.

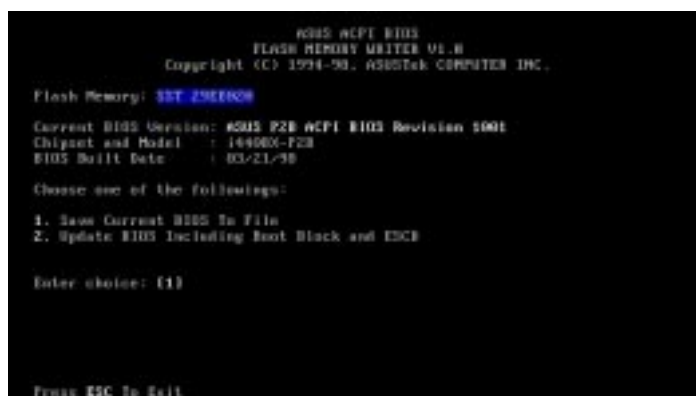

IMPORTANT! If “unknown” is displayed after **Flash Memory:**, the memory chip is either not programmable or is not supported by the ACPI BIOS and therefore, cannot be programmed by the Flash Memory Writer utility.

Main Menu

1. Save Current BIOS To File

This option allows you to save a copy of the original motherboard BIOS in case you need to reinstall it. It is recommended that you save **AFLASH.EXE** and the BIOS file to a bootable floppy disk.

To save your current BIOS, type [1] at the **Main Menu** and then press <Enter>. The **Save Current BIOS To File** screen appears.

Type a filename and the path, for example, **A:\XXX-X** and then press <Enter>.

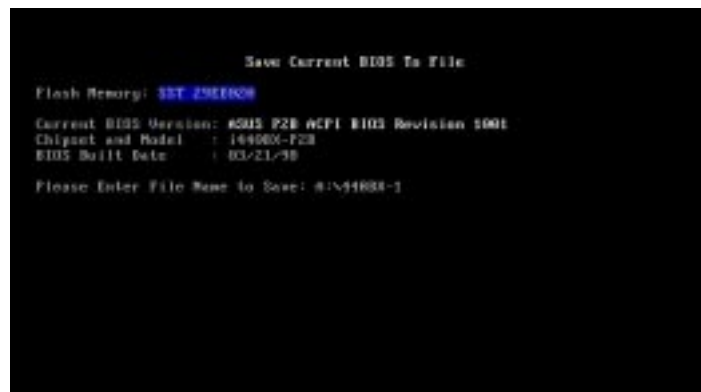

IV. BIOS SOFTWARE

2. Update BIOS Including Boot Block and ESCD

This option updates the boot block, the baseboard BIOS, and the ACPI extended system configuration data (ESCD) parameter block from a new BIOS file. See the next page for procedures on downloading an updated BIOS file.

To update your current BIOS, type [2] at the **Main Menu** and then press <Enter>. The **Update BIOS Including Boot Block and ESCD** screen appears. Type the filename of your new BIOS and the path, for example, **A:\XXXXXXXX.AWD**, and then press <Enter>.

When prompted to confirm the BIOS update, press **Y** to start the update.

The utility starts to program the new BIOS information into the flash ROM. When the programming is finished, *Flashed Successfully* will be displayed.

Follow the onscreen instructions to continue.

```
Update BIOS Including Boot Block and ESCD
Flash Memory: SST 25CF000
Current BIOS Version: 6015 P2B ACPI BIOS Revision 1001
Chipset and Model : 149605-P2B
BIOS Build Date : 03/21/98
Please Enter File Name for NEW BIOS: A:\XXXXXXXX.AWD
```

```
Update BIOS Including Boot Block and ESCD
Flash Memory: SST 25CF000
BIOS Version
I CURRENT I 6015 P2B ACPI BIOS Revision 1001
EDG211002.AWD) 6015 P2B ACPI BIOS Revision 1002
Chipset and Model
I CURRENT I 14960X-<CF2B>>-B
EDG211002.AWD) 14960X-<CF2B>>-B
Date of BIOS Build
I CURRENT I 03/21/98
EDG211002.AWD) 03/25/98
Are you sure (Y/N) ? [Y]
Press ESC To Return to Main Menu
```

```
Update BIOS Including Boot Block and ESCD
Flash Memory: SST 25CF000
BIOS Version
I CURRENT I 6015 P2B ACPI BIOS Revision 1001
EDG211002.AWD) 6015 P2B ACPI BIOS Revision 1002
Chipset and Model
I CURRENT I 14960X-<CF2B>>-B
EDG211002.AWD) 14960X-<CF2B>>-B
Date of BIOS Build
I CURRENT I 03/21/98
EDG211002.AWD) 03/25/98
Are you sure (Y/N) ? [Y]
Programming -- 3FFF
Flashed Successfully
Press ESC To Return to Main Menu
```

```
ACPI BIOS
FLASH MEMORY WRITER V1.0
Copyright (C) 1994-98, ASUS/TECH COMPUTER INC.
Flash Memory: SST 25CF000
Current BIOS Version: 6015 P2B-L5 ACPI BIOS Revision 1001 Beta 015
Chipset and Model : 14960X-P2B-L5
BIOS Build Date : 03/20/98
Choose one of the followings:
1. Save Current BIOS To File
2. Update BIOS Including Boot Block and ESCD
Enter choice: [1]
You have flashed the EPROM. It is recommended that you turn off
the power, enter SETUP and Load Setup Defaults to have CMOS
updated with new BIOS when exits.
Press ESC To Exit
```

IV. BIOS SOFTWARE

Managing and Updating Your Motherboard's BIOS

Upon First Use of the Computer System

1. Create a bootable system floppy disk by typing [FORMAT A:/S] from the DOS prompt without creating "AUTOEXEC.BAT" and "CONFIG.SYS" files.
2. Copy AFLASH.EXE to the just created boot disk.
3. Run AFLASH.EXE from this new disk and select option **1. Save Current BIOS to File**. See **1. Save Current BIOS To File** on the previous page for more details and the rest of the steps.

Updating BIOS Procedures (only when necessary)

1. Download an updated ASUS BIOS file from the Internet (WWW or FTP) or a BBS (Bulletin Board Service) (see ASUS CONTACT INFORMATION on page 3 for details) and save to the disk you created earlier.
2. Boot from the disk you created earlier.
3. At the "A:\\" prompt, type **AFLASH** and then press <Enter>.
4. At the **Main Menu**, type **2** and then press <Enter>. See **2. Update BIOS Including Boot Block and ESCD** on the previous page for more details and the rest of the steps.

WARNING! If you encounter problems while updating the new BIOS, DO NOT turn off your system since this might prevent your system from booting up. Just repeat the process, and if the problem still persists, update the original BIOS file you saved to disk above. If the Flash Memory Writer utility was not able to successfully update a complete BIOS file, your system may not be able to boot up. If this happens, your system will need service.

IV. BIOS SOFTWARE

6. BIOS Setup

The motherboard supports two programmable Flash ROM chips: 5 Volt and 12 Volt. Either of these memory chips can be updated when BIOS upgrades are released. Use the Flash Memory Writer utility to download the new BIOS file into the ROM chip as described in detail in this section.

All computer motherboards provide a Setup utility program for specifying the system configuration and settings. If your motherboard came in a computer system, the proper configuration entries may have already been made. If so, invoke the Setup utility, as described later, and take note of the configuration settings for future reference; in particular, the hard disk specifications.

If you are installing the motherboard, reconfiguring your system or you receive a Run Setup message, you will need to enter new setup information. This section describes how to configure your system using this utility.

The BIOS ROM of the system stores the Setup utility. When you turn on the computer, the system provides you with the opportunity to run this program. This appears during the Power-On Self Test (POST). Press <Delete> to call up the Setup utility. If you are a little bit late pressing the mentioned key(s), POST will continue with its test routines, thus preventing you from calling up Setup. If you still need to call Setup, reset the system by pressing <Ctrl> + <Alt> + <Delete>, or by pressing the Reset button on the system case. You can also restart by turning the system off and then back on again. But do so only if the first two methods fail.

When you invoke Setup, the CMOS SETUP UTILITY main program screen will appear with the following options:



IV. BIOS SOFTWARE

Load Defaults

The “Load BIOS Defaults” option loads the minimum settings for troubleshooting. “**Load Setup Defaults**”, on the other hand, is for loading optimized defaults for regular use. Choosing defaults at this level, will modify all applicable settings.

A section at the bottom of the above screen displays the control keys for this screen. Take note of these keys and their respective uses. Another section just below the control keys section displays information on the currently highlighted item in the list.

Standard CMOS Setup

The “Standard CMOS Setup” option allows you to record some basic system hardware configuration and set the system clock and error handling. If the motherboard is already installed in a working system, you will not need to select this option. However, if the configuration stored in the CMOS memory on the board gets lost or damaged, or if you change your system hardware configuration, you will need to respecify the configuration values. The configuration values usually get lost or corrupted when the power of the onboard CMOS battery weakens.



The preceding screen provides you with a list of options. At the bottom of this screen are the control keys for this screen. Take note of these keys and their respective uses.

User-configurable fields appear in a different color. If you need information on the selected field, press <F1>. The help menu will then appear to provide you with the information you need. The memory display at the lower right-hand side of the screen is read-only and automatically adjusts accordingly.

Details of Standard CMOS Setup:

Date

To set the date, highlight the “Date” field and then press either <Page Up>/<Page Down> or <+>/<-> to set the current date. Follow the month, day and year format. Valid values for month, day and year are: **Month: (1 to 12), Day: (1 to 31), Year: (up to 2079)**

IV. BIOS SOFTWARE

Time

To set the time, highlight the “Time” field and then press either <Page Up>/<Page Down> or <+>/<-> to set the current time. Follow the hour, minute and second format. Valid values for hour, minute and second are: (**Hour: (00 to 23)**, **Minute: (00 to 59)**, **Second: (00 to 59)**).

NOTE: You can bypass the date and time prompts by creating an AUTOEXEC.BAT file. For information on how to create this file, please refer to the MS-DOS manual.

Hard Disks

This field records the specifications for all non-SCSI hard disk drives installed in your system. The onboard PCI IDE connectors provide Primary and Secondary channels for connecting up to four IDE hard disks or other IDE devices. Each channel can support up to two hard disks; the first of which is the “master” and the second is the “slave”.

Specifications for SCSI hard disks need not to be entered here since they operate using device drivers and are not supported by any the BIOS. If you install either the optional PCI-SC200 or PCI-SC860 SCSI controller card into the motherboard, see section VI for instructions. If you install other vendor’s SCSI controller card, refer to their respective documentations on how to install the required SCSI drivers.

For IDE hard disk drive setup, you can:

- Use the *Auto* setting for detection during bootup.
- Use the IDE HDD AUTO DETECTION in the main menu to automatically enter the drive specifications.
- Enter the specifications yourself manually by using the “User” option.

The entries for specifying the hard disk type include **CYLS** (number of cylinders), **HEAD** (number of read/write heads), **PRECOMP** (write precompensation), **LANDZ** (landing zone), **SECTOR** (number of sectors) and **MODE**. The **SIZE** field automatically adjusts according to the configuration you specify. The documentation that comes with your hard disk should provide you with the information regarding the drive specifications.

The **MODE** entry is for IDE hard disks only, and can be ignored for MFM and ESDI drives. This entry provides three options: *Normal*, *Large*, *LBA*, or *Auto* (see below). Set **MODE** to the *Normal* for IDE hard disk drives smaller than 528MB; set it to *LBA* for drives over 528MB that support Logical Block Addressing (LBA) to allow larger IDE hard disks; set it to *Large* for drives over 528MB that do not support LBA. *Large* type of drive can only be used with MS-DOS and is very uncommon. Most IDE drives over 528MB support the *LBA* mode.

IV. BIOS SOFTWARE

Auto detection of hard disks on bootup

For each field: Primary Master, Primary Slave, Secondary Master, and Secondary Slave, you can select *Auto* under the TYPE and MODE fields. This will enable auto detection of your IDE hard disk during bootup. This will allow you to change your hard disks (with the power off) and then power on without having to reconfigure your hard disk type. If you use older hard disks that do not support this feature, then you must configure the hard disk in the standard method as described earlier by the “User” option.

NOTE: After the IDE hard disk drive information has been entered into BIOS, new IDE hard disk drives must be partitioned (such as with FDISK) and then formatted before data can be read from and write on. Primary IDE hard disk drives must have its partition set to *active* (also possible with FDISK).

NOTE: SETUP Defaults are noted in parenthesis next to each function heading.

Drive A (None)

This field records the types of floppy disk drives installed in your system. The available options for drive A are: *360K, 5.25 in.; 1.2M, 5.25 in.; 720K, 3.5 in.; 1.44M, 3.5 in.; 2.88M, 3.5 in.; None.*

Floppy 3 Mode Support (Disabled)

This is the Japanese standard floppy drive. The standard stores 1.2MB in a 3.5inch diskette. This is normally disabled but you may choose from either: *Drive A* and *Disabled*.

Video (EGA/VGA)

Set this field to the type of video display card installed in your system. The options are *EGA/VGA, CGA 40, CGA 80, and MONO* (for Hercules or MDA).

If you are using a VGA or any higher resolution card, choose *EGA/VGA*.

Halt On (All Errors)

This field determines which types of errors will cause the system to halt. Choose from *All Errors; No Errors; All, But Keyboard, All, But Diskette; and All, But Disk/Key.*

IV. BIOS SOFTWARE

BIOS Features Setup

The “BIOS Features Setup” option consists of configuration entries that allow you to improve your system performance, or let you set up some system features according to your preference. Some entries are required by the motherboard’s design to remain in their default settings.



A section at the lower right of the screen displays the control keys you can use. Take note of these keys and their respective uses. If you need information on a particular entry, highlight it and then press <F1>. A pop-up help menu will appear to provide you with the information you need. <F5> loads the last set values, <F6> and <F7> loads the BIOS default values and Setup default values, respectively.

NOTE: SETUP Defaults are noted in parenthesis next to each function heading.

Details of BIOS Features Setup

CPU Internal Core Speed

This function is reserved for future use and is currently disabled.

Boot Virus Detection (Enabled)

This field allows you to set boot virus detection, ensuring a virus-free boot sector. This new antivirus solution is unlike native BIOS tools, which offer limited virus protection typically by write-protecting the partition table. With this new solution, your computer is protected against boot virus threats earlier in the boot cycle, that is, before they have a chance to load into your system. This ensures your computer boots to a clean operating system. The system halts and displays a warning message when it detects a virus. If this occurs, you can either allow the operation to continue or use a virus-free bootable floppy disk to restart and investigate your system. Because of conflicts with new operating systems, for example, during installation of new softwares, you may have to set this to *Disabled* to prevent write errors.

IV. BIOS SOFTWARE

CPU Level 1 Cache / CPU Level 2 Cache (Enabled)

These fields allow you to choose from the default of *Enabled* or choose *Disabled* to turn on or off the CPU's Level 1 and Level 2 built-in cache.

CPU Level 2 Cache ECC Check (Disabled)

This function controls the ECC check capability in the CPU level 2 cache.

BIOS Update (Enabled)

This functions as an update loader integrated into the BIOS to supply the processor with the required data. The BIOS will load the update on all processors during system bootup in the default position of *Enabled*.

Turbo Mode (Disabled)

Leave on default setting for best performance.

Quick Power On Self Test (Enabled)

This field speeds up the Power-On Self Test (POST) routine by skipping retesting a second, third, and fourth time. Setup default setting for this field is *Enabled*. A complete test of the system is done on each test.

HDD Sequence SCSI/IDE First (IDE)

When using both SCSI and IDE hard disk drives, IDE is always the boot disk using drive letter C (default setting of *IDE*). This new feature allows a SCSI hard disk drive to be the boot disk when set to *SCSI*. This allows multiple operating systems to be used on both IDE and SCSI drives or the primary operating system to boot using a SCSI hard disk drive.

Boot Sequence (A,C)

This field determines where the system looks first for an operating system. Options are A, C; C, A; A, CDROM, C; CDROM, C, A; D, A; E, A; F, A; C only; LS/ZIP, C; LAN, A, C; and LAN, C, A. The setup default setting is to check first the floppy disk and then the hard disk drive, that is, A, C.

Boot Up Floppy Seek (Disabled)

When enabled, the BIOS will seek drive A once.

Floppy Disk Access Control (R/W)

This allows protection of files from the computer system to be copied to floppy disks by allowing the setting of *Read Only* to only allow reads from the floppy disk drive but not writes. The setup default R/W allows both reads and writes.

IDE HDD Block Mode Sectors (HDD MAX)

This field enhances hard disk performance by making multi-sector transfers instead of one sector per transfer. Most IDE drives, except older versions, can utilize this feature. Selections are *HDD MAX*, *Disabled*, 2, 4, 8, 16, and 32.

IV. BIOS SOFTWARE

HDD S.M.A.R.T. capability (Disabled)

This allows the enabling or disabling of the S.M.A.R.T. (Self-Monitoring, Analysis and Reporting Technology) system which utilizes internal hard disk drive monitoring technology. This feature is normally disabled because system resources used in this feature may decrease system performance.

PS/2 Mouse Function Control (Auto)

The default of *Auto* allows the system to detect a PS/2 mouse on bootup. If detected, IRQ12 will be used for the PS/2 mouse. IRQ12 will be reserved for expansion cards if a PS/2 mouse is not detected. *Enabled* will always reserve IRQ12, whether on bootup a PS/2 mouse is detected or not.

OS/2 Onboard Memory > 64M (Disabled)

When using OS/2 operating systems with installed DRAM of greater than 64MB, you need to set this option to *Enabled* otherwise leave this on *Disabled*.

.....

PCI/VGA Palette Snoop (Disabled)

Some display cards that are nonstandard VGA such as graphics accelerators or MPEG Video Cards may not show colors properly. The setting *Enabled* should correct this problem. Otherwise leave this on the setup default setting of *Disabled*.

Video ROM BIOS Shadow (Enabled)

This field allows you to change the video BIOS location from ROM to RAM. Relocating to RAM enhances system performance, as information access is faster than the ROM.

C8000-CBFFF to DC000-DFFFF (Disabled)

These fields are used for shadowing other expansion card ROMs. If you install other expansion cards with ROMs on them, you will need to know which addresses the ROMs use to shadow them specifically. Shadowing a ROM reduces the memory available between 640K and 1024K by the amount used for this purpose.

Boot Up NumLock Status (On)

This field enables users to activate the Number Lock function upon system boot.

Typematic Rate Setting (Disabled)

When enabled, you can set the two typematic controls listed next. Setup default setting is *Disabled*.

Typematic Rate (Chars/Sec) (6)

This field controls the speed at which the system registers repeated keystrokes. Options range from 6 to 30 characters per second. Setup default setting is **6**; other settings are 8, 10, 12, 15, 20, 24, and 30.

Typematic Delay (Msec) (250)

This field sets the time interval for displaying the first and second characters. Four delay rate options are available: 250, 500, 750, and 1000.

Security Option (System)

When you specify a *Supervisor Password* and/or *User Password* (explained later in this section), the Security Option field determines when the system prompts for the password. The default setting is **System**, where the system prompts for the User Password every time you start your system. The other option is *Setup*, where the system goes through its startup routine unless the Setup utility is called, when the system prompts for the Supervisor Password.

IV. BIOS SOFTWARE

Chipset Features Setup

The “Chipset Features Setup” option controls the configuration of the board’s chipset. Control keys for this screen are the same as for the previous screen.



NOTE: SETUP Defaults are noted in parenthesis next to each function heading.

Details of Chipset Features Setup

SDRAM Configuration (By SPD)

This sets the optimal timings for items 2-5. Leave on default setting.

SDRAM CAS Latency (2T)

This controls the latency between SDRAM read command and the time that the data actually becomes available. Leave on default setting.

SDRAM RAS to CAS Delay (2T)

This controls the latency between SDRAM active command and the read/write command. Leave on default setting.

SDRAM RAS Precharge Time (2T)

This controls the idle clocks after issuing a precharge command to SDRAM. Leave on default setting.

DRAM Idle Timer (0T)

This controls the idle clocks before closing an opened SDRAM page. Leave on default setting.

SDRAM MA Wait State (Normal)

This controls the leadoff clocks for CPU read cycles. Leave on default setting.

Snoop Ahead (Enabled)

Enabled will allow PCI streaming. Leave on default setting.

Host Bus Fast Data Ready (Disabled)

Leave on default setting.

16-bit I/O Recovery Time (1 BUSCLK) / 8-bit I/O Recovery Time (1 BUSCLK)

Timing for 16-bit and 8-bit ISA cards, respectively. Leave on default setting.

IV. BIOS SOFTWARE

Graphics Aperture Size (64MB)

Memory-mapped, graphics data structures can reside in a Graphics Aperture. Leave on default setting.

Video Memory Cache Mode (UC)

USWC (uncacheable, speculative write combining) is a new cache technology for the video memory of the processor. It can greatly improve the display speed by caching the display data. You must leave this on the default setting of UC (uncacheable) if your display card cannot support this feature or else your system may not boot.

PCI 2.1 Support (Enabled)

This function allows you to enable or disable PCI 2.1 features including passive release and delayed transaction. Leave *Enabled* (default setting) for PCI 2.1 compliancy.

Memory Hole At 15M–16M (Disabled)

Enabling this feature reserves 15MB to 16MB memory address space to ISA expansion cards that specifically require this setting. This makes the memory from 15MB and up unavailable to the system. Expansion cards can only access memory up to 16MB. The default is *Disabled*.

DRAM are xx bits wide

If all your DIMMs have ECC (e.g., 8 chips + 1 ECC chip), they are considered 72bits and the following will be displayed:

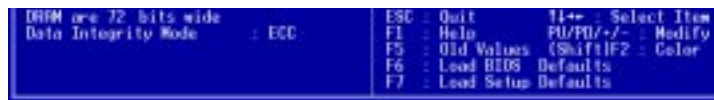

If your DIMMs do not have ECC (e.g. 8 chips), they are considered 64 bits and the following will be displayed instead:

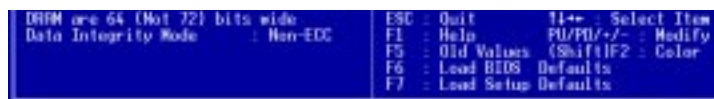

Data Integrity Mode (Non-ECC)

Non-ECC has byte-wise write capability but no provision for protecting data integrity in the DRAM array. *EC-Only* data errors are detected but not corrected. *ECC* with hardware scrubbing allows a detection of single-bit and multiple-bit errors and recovery of single-bit errors. (See section III for more information on DRAM memory modules.)

.....

Onboard FDC Controller (Enabled)

When *Enabled*, this field allows you to connect your floppy disk drives to the onboard floppy disk drive connector instead of a separate controller card. If you want to use a different controller card to connect the floppy disk drives, set this field to *Disabled*.

IV. BIOS SOFTWARE

Onboard FDC Swap A & B (No Swap)

This field allows you to reverse the hardware drive letter assignments of your floppy disk drives. Two options are available: *No Swap* and *Swap AB*. If you want to switch drive letter assignments through the onboard chipset, set this field to *Swap AB*.

Onboard Serial Port 1 (3F8H/IRQ4)

Settings are *3F8H/IRQ4*, *2F8H/IRQ3*, *3E8H/IRQ4*, *2E8H/IRQ10*, and *Disabled* for the onboard serial connector.

Onboard Serial Port 2 (2F8H/IRQ3)

Settings are *3F8H/IRQ4*, *2F8H/IRQ3*, *3E8H/IRQ4*, *2E8H/IRQ10*, and *Disabled* for the onboard serial connector.

Onboard Parallel Port (378H/IRQ7)

This field sets the address of the onboard parallel port connector. You can select either: *3BCH/IRQ 7*, *378H/IRQ 7*, *278H/IRQ 5*, *Disabled*. If you install an I/O card with a parallel port, ensure that there is no conflict in the address assignments. The PC can support up to three parallel ports as long as there are no conflicts for each port.

Parallel Port Mode (ECP+EPP)

This field allows you to set the operation mode of the parallel port. The setting *Normal*, allows normal-speed operation but in one direction only; *EPP* allows bidirectional parallel port operation at maximum speed; *ECP* allows the parallel port to operate in bidirectional mode and at a speed faster than the maximum unidirectional data transfer rate; *ECP+EPP* allows normal speed operation in a two-way mode.

ECP DMA Select (3)

This selection is available only if you select *ECP* or *ECP+EPP* in the **Parallel Port Mode**. Select either DMA Channel *1*, *3*, or *Disable*.

UART2 Use Infrared (Disabled)

When enabled, this field activates the onboard infrared feature and sets the second serial UART to support the infrared module connector on the motherboard. If your system already has a second serial port connected to the onboard COM2 connector, it will no longer work if you enable the infrared feature. By default, this field is set to *Disabled*, which leaves the second serial port UART to support the COM2 serial port connector. See **IrDA-compliant infrared module connector** under section III.

Onboard PCI IDE Enable (Both)

You can select to enable the *primary* IDE channel, *secondary* IDE channel, *both*, or *disable* both channels (for systems with only SCSI drives).

IDE Ultra DMA Mode (Auto)

This field autodetects Ultra DMA capability (for improved transfer speeds and data integrity) for compatible IDE devices. Set to *Disable* to suppress Ultra DMA capability.

IDE 0 Master/Slave PIO/DMA Mode, IDE 1 Master/Slave PIO/DMA Mode (Auto)

Each channel (0 and 1) has both a master and a slave making four IDE devices possible. Because each IDE device may have a different Mode timing (0, 1, 2, 3, 4), it is necessary for these to be independent. The default setting of *Auto* will allow autodetection to ensure optimal performance

IV. BIOS SOFTWARE

Power Management Setup

The “Power Management Setup” option allows you to reduce power consumption. This feature turns off the video display and shuts down the hard disk after a period of inactivity.



NOTE: SETUP Defaults are noted in parenthesis next to each function heading.

Details of Power Management Setup

Power Management (User Define)

This field acts as the master control for the power management modes. *Max Saving* puts the system into power saving mode after a brief period of system inactivity; *Min Saving* is almost the same as *Max Saving* except that this time the system inactivity period is longer; *Disable* disables the power saving features; *User Define* allows you to set power saving options according to your preference.

IMPORTANT: Advanced Power Management (APM) should be installed to keep the system time updated when the computer enters suspend mode activated by the BIOS Power Management. For DOS environments, you need to add the statement, `DEVICE=C:\DOS\POWER.EXE`, in you `CONFIG.SYS`. For Windows 3.x and Windows 95, you need to install Windows with the APM feature. A battery and power cord icon labeled “Power” will appear in the “Control Panel.” Choose “Advanced” in the Power Management Field.

Video Off Option (Suspend -> Off)

This field determines when to activate the video off feature for monitor power management. The settings are *Suspend -> Off* and *Always On*.

IV. BIOS SOFTWARE

Video Off Method (DPMS OFF)

This field defines the video off features. The following options are available: *DPMS OFF*, *DPMS Reduce ON*, *Blank Screen*, *V/H SYNC+Blank*, *DPMS Standby*, and *DPMS Suspend*. The DPMS (Display Power Management System) features allow the BIOS to control the video display card if it supports the DPMS feature. *Blank Screen* only blanks the screen (use this for monitors without power management or “green” features. If set up in your system, your screen saver will not display with *Blank Screen* selected). *V/H SYNC+Blank* blanks the screen and turns off vertical and horizontal scanning.

.....

PM Timers

This section controls the time-out settings for the Power Management scheme. The fields included in this section are “HDD Power Down”, which places the hard disk into its lowest power consumption mode, and the Suspend mode which suspends the CPU.

The system automatically “wakes up” from any power saving mode when there is system activity such as when a key is pressed from the keyboard, or when there is activity detected from the enabled IRQ channels.

HDD Power Down (Disable)

Shuts down any IDE hard disk drives in the system after a period of inactivity. This time period is user-configurable to *1–15 Min* or *Disable*. This feature does not affect SCSI hard drives.

Suspend Mode (Disable)

Sets the period of time after which each of these modes activate: *30 sec*, *1 Min*, *2 Min*, *4 Min*, *8 Min*, *20 Min*, *30 Min*, *40 Min*, *1 Hour*, and *Disable*.

.....

Power Up Control

This section determines the ways the system can be controlled when it is started or restarted, when modem activity is detected, or when power to the computer is interrupted and reapplied. The Soft-Off mode refers to powering off the system through a momentary button switch (ATX switch) or through the software as opposed to disconnecting the AC power by way of a rocker switch or other means.

PWR Button < 4 Secs (Soft Off)

When set to *Soft Off*, the ATX switch can be used as a normal system power-off button when pressed for less than 4 seconds. *Suspend* allows the button to have a dual function where pressing less than 4 seconds will place the system in sleep mode. Regardless of the setting, holding the ATX switch for more than 4 seconds will power off the system.

IV. BIOS SOFTWARE

PWR Up On Modem Act (Enabled)

This allows either settings of *Enabled* or *Disabled* for powering up the computer (turns the ATX power supply on) when the modem receives a call while the computer is *Soft Off*.

NOTE: The computer cannot receive or transmit data until the computer and applications are fully running, thus connection cannot be made on the first try. Turning an external modem off and then back on while the computer is off causes an initialization string that will also cause the system to power on.

AC PWR Loss Restart (Disabled)

This allows you to set whether you want your system to boot up after the power has been interrupted. *Disabled* leaves your system off after reapplying power and *Enabled* boots up your system after reapplying power.

Power Up By Keyboard (Disabled)

This allows the computer to be powered on by pressing any key on the keyboard. Set of *Enabled* to set this feature. **WARNING:** This setting must coincide with the keyboard power up jumper setting or else conflicts will occur.

Wake On LAN (Enabled)

This allows you to remotely power up your system through your network by sending a wake-up frame or signal. With this feature, you can remotely upload/download data to/from systems during off-peak hours. Set to *Enabled* to set this feature.

IMPORTANT: This feature requires the ASUS PCI-L101 LAN Card and an ATX power supply with at least 720mA +5V standby power.

Automatic Power Up (Disabled)

This allows you to have an unattended or automatic power up of your system. You may configure your system to power up at a certain time of the day by selecting *Everyday*, which will allow you to set the time or at a certain time and day by selecting *By Date*.

IV. BIOS SOFTWARE

PNP and PCI Setup

The “PNP and PCI Setup” option configures the PCI bus slots. All PCI bus slots on the system use INTA#, thus all installed PCI cards must be set to this value.



NOTE: SETUP Defaults are noted in parenthesis next to each function heading.

Details of PNP and PCI Setup

PNP OS Installed (No)

This field allows you to use a Plug-and-Play (PnP) operating system to configure the PCI bus slots instead of using the BIOS. Thus interrupts may be reassigned by the OS when *Yes* is selected. When a non-PnP OS is installed or to prevent reassigning of interrupt settings, select the default setting of *No*.

Slot 1/2/3/4/5 IRQ (Auto)

These fields set how IRQ use is determined for each PCI slot. The default setting for each field is *Auto*, which uses auto-routing to determine IRQ use. The other options are manual settings of *NA*, *3*, *4*, *5*, *7*, *9*, *10*, *11*, *12*, *14*, or *15* for each slot.

PCI Latency Timer (32 PCI Clock)

The default setting of *32 PCI Clock* enables maximum PCI performance for this motherboard.

IRQ xx Used By ISA (No/ICU)

These fields indicate whether or not the displayed IRQ for each field is being used by a legacy (non-PnP) ISA card. Two options are available: *No/ICU* and *Yes*. The first option, the default value, indicates either that the displayed IRQ is not used or an ISA Configuration Utility (ICU) is being used to determine if an ISA card is using that IRQ. If you install a legacy ISA card that requires a unique IRQ, and you are not using an ICU, you must set the field for that IRQ to *Yes*. For example: If you install a legacy ISA card that requires IRQ 10, then set **IRQ10 Used By ISA** to *Yes*.

.....

IV. BIOS SOFTWARE

DMA x Used By ISA (No/ICU)

These fields indicate whether or not the displayed DMA channel for each field is being used by a legacy (non-PnP) ISA card. Available options include: *No/ICU* and *Yes*. The first option, the default setting, indicates either that the displayed DMA channel is not used or an ICU is being used to determine if an ISA card is using that channel. If you install a legacy ISA card that requires a unique DMA channel, and you are not using an ICU, you must set the field for that channel to *Yes*.

ISA MEM Block BASE (No/ICU)

This field allows you to set the base address and block size of a legacy ISA card that uses any memory segment within the C800H and DFFFH address range. If you have such a card, and you are not using an ICU to specify its address range, select a base address from the six available options; the **ISA MEM Block SIZE** field will then appear for selecting the block size. If you have more than one legacy ISA card in your system that requires to use this address range, you can increase the block size to either 8K, 16K, 36K, or 64K. If you are using an ICU to accomplish this task, leave **ISA MEM Block BASE** to its default setting of *No/ICU*.

SYMBIOS SCSI BIOS (Auto)

The default uses *Auto* settings for the onboard SCSI BIOS. If you do not want to use the onboard SCSI BIOS, choose *Disabled*

USB IRQ (Enabled)

Enabled reserves an IRQ# for the USB to work, *Disabled* does not allow the USB to have an IRQ# and therefore prevents the USB from functioning. If you are not using any USB devices, you may set this feature to *Disabled* to save an extra IRQ# for expansion cards.

ONB VGA BIOS First (No)

This field gives priority to the onboard VGA BIOS over other VGA controllers. The default setting for this field is *No*.

IV. BIOS SOFTWARE

Load BIOS Defaults

The “Load BIOS Defaults” option allows you to load the troubleshooting default values permanently stored in the BIOS ROM. These default settings are non-optimal and disable all high performance features. To load these default settings, highlight “Load BIOS Defaults” on the main screen and then press <Enter>. The system displays a confirmation message on the screen. Press <Y> and then <Enter> to confirm. Press <N> and then <Enter> to abort. This feature does not affect the fields on the Standard CMOS Setup screen.

Load Setup Defaults

The “Load Setup Defaults” option allows you to load the default values to the system configuration fields. These default values are the optimized configuration settings for the system. To load these default values, highlight “Load Setup Defaults” on the main screen and then press <Enter>. The system displays a confirmation message on the screen. Press <Y> and then <Enter> to confirm. Press <N> and then <Enter> to abort. This feature does not affect the fields on the Standard CMOS Setup screen.



IV. BIOS SOFTWARE

Supervisor Password and User Password

These two options set the system passwords. “Supervisor Password” sets a password that will be used to protect the system and the Setup utility; “User Password” sets a password that will be used exclusively on the system. By default, the system comes without any passwords. To specify a password, highlight the type you want and then press <Enter>. A password prompt appears on the screen. Taking note that the password is case sensitive, and can be up to 8 alphanumeric characters long, type in your password and then press <Enter>. The system confirms your password by asking you to type it again. After setting a password, the screen automatically reverts to the main screen.



To implement password protection, specify in the “Security Option” field of the BIOS Features Setup screen when the system will prompt for the password. If you want to disable either password, press <Enter> instead of entering a new password when the “Enter Password” prompt appears. A message confirms the password has been disabled.

NOTE: If you forget the password, see CMOS RAM for procedures on clearing the CMOS.

IV. BIOS SOFTWARE

IDE HDD Auto Detection

The “IDE HDD Auto Detection” option detects the parameters of an IDE hard disk drive, and automatically enters them into the Standard CMOS Setup screen.

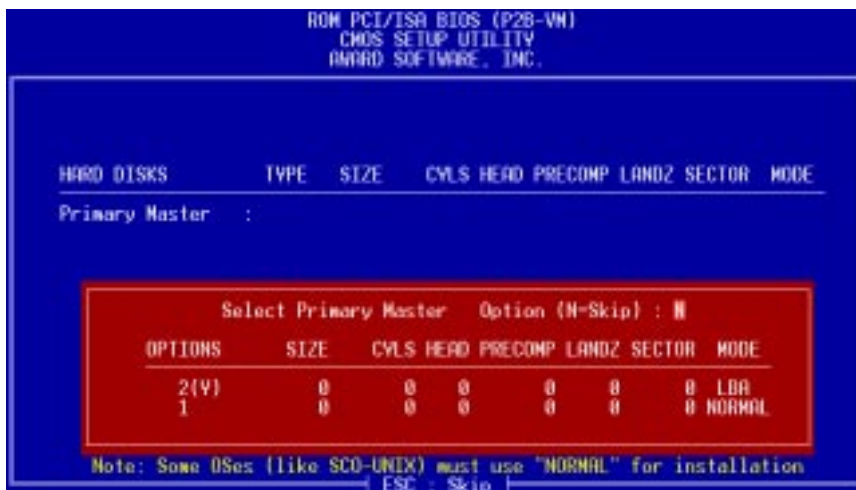

Up to four IDE drives can be detected, with parameters for each listed inside the box. To accept the optimal entries, press <Y> or else select from the numbers displayed under the OPTIONS field (2, 1, 3 in this case); to skip to the next drive, press <N>. If you accept the values, the parameters will appear listed beside the drive letter on the screen. The process then proceeds to the next drive letter. Pressing <N> to skip rather than to accept a set of parameters causes the program to enter zeros after that drive letter.

Remember that if you are using another IDE controller that does not feature Enhanced IDE support for four devices, you can only install two IDE hard disk drives. Your IDE controller must support the Enhanced IDE features in order to use Drive E and Drive F. The onboard PCI IDE controller supports Enhanced IDE, with two connectors for connecting up to four IDE devices. If you want to use another controller that supports four drives, you must disable the onboard IDE controller in the Chipset Features Setup screen.

When auto-detection is completed, the program automatically enters all entries you accepted on the field for that drive in the Standard CMOS Setup screen. Skipped entries are ignored and are not entered in the screen.

If you are auto-detecting a hard disk that supports the LBA mode, three lines will appear in the parameter box. Choose the line that lists LBA for an LBA drive. Do not select Large or Normal.

The auto-detection feature can only detect one set of parameters for a particular IDE hard drive. Some IDE drives can use more than one set. This is not a problem if the drive is new and empty.

IV. BIOS SOFTWARE

IMPORTANT: If your hard disk was already formatted on an older previous system, incorrect parameters may be detected. You will need to enter the correct parameters manually or use low-level format if you do not need the data stored on the hard disk.

If the parameters listed differ from the ones used when the disk was formatted, the disk will not be readable. If the auto-detected parameters do not match the ones that should be used for your disk, do not accept them. Press <N> to reject the presented settings and enter the correct ones manually from the Standard CMOS Setup screen.

Save & Exit Setup

Select this option to save into the CMOS memory all modifications you specified during the current session. To save the configuration changes, highlight the “Save & Exit Setup” option on the main screen, type “Y”, and then press <Enter>.

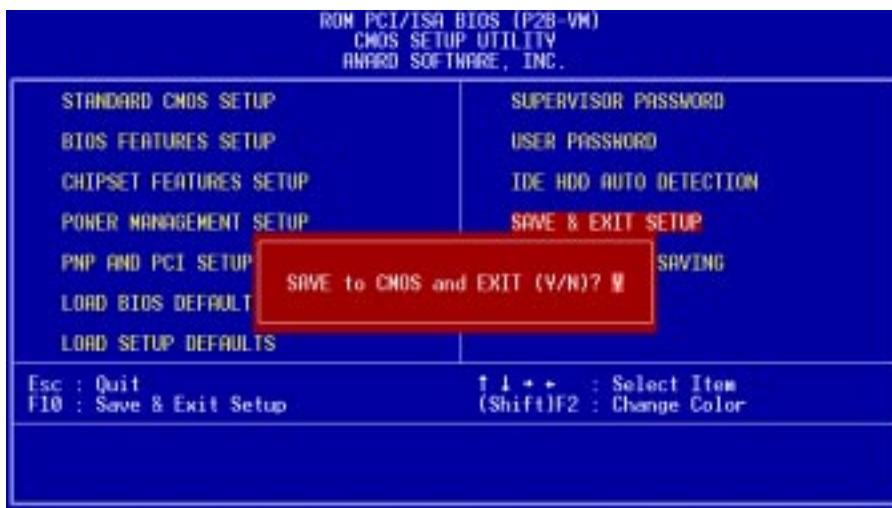

Exit Without Saving

Select this option to exit the Setup utility without saving the modifications you specify during the current session. To exit without saving, highlight the “Exit Without Saving” option on the main screen and then press <Enter>.

V. SUPPORT CD

ASUS Support CD Main Menu

Insert your support CD or double-click your CD drive icon in “My Computer” to bring up the autorun menu or run Setup.exe in the root directory of the ASUS support CD.

NOTE: The CD version and contents are constantly modified without notice.

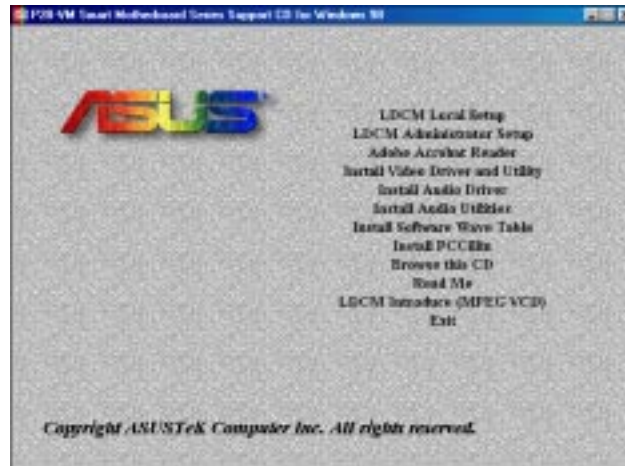

- **LDCM Local Setup:** Installs software to monitor the local system. The LANDesk Client Manager must be installed in order to use the hardware manager features.
- **LDCM Administrator Setup:** Installs software to monitor PC systems on the network within the same bridge address with the Local software installed. The administrator should install both Local and Administrator Software.
- **Adobe Acrobat Reader:** Installs the Adobe Acrobat Reader software necessary to view the LDCM manual in the LDCM directory.
- **BusMaster:** Installs the Intel BusMaster IDE drivers.
- **Install Video Driver and Utility:** Installs the video driver and utilities for the onboard VGA chipset.
- **Install Audio Driver:** Audio driver installation instructions for the onboard audio.
- **Install Audio Utilities:** Installs AudioRack32 audio utility.
- **Install Software Wave Table:** Expands the audio sound capability for increased sound effects.
- **Patch for PIIX4 chipset:** Installs the necessary drivers for PCI card and PCI bridge for Windows 95/95a (OSR1) and 95b (OSR2) for ASUS motherboards.
- **Install PCCillin:** Installs “PC-cillin” virus protection software. View the online help if you have any questions.
- **Browse this CD:** Allows you to see the contents of the ASUS support CD.
- **Read Me:** View additional notes with Notepad.
- **LDCM Introduce (MPEG VCD):** View a video on the LDCM features.
- **Exit:** Exit the selection menu .

Additional CD Contents: DMI Configuration Utility in the **DMI** directory and Flash BIOS writer in the **AFLASH** directory.

V. Support CD

A. Video Driver	61
First Time Installation	61
Operating Systems	61
Install Video Driver and Utility (Windows 95/98)	62
Display Settings for Windows 95/98	63
Adjustment Menu	63
Panning Menu	63
Color	64
Settings	64
B. Other Video Drivers	65
Video Driver Installation for Windows NT 4.0	65
Installing Video Drivers for Windows NT 4.0	65
Video Driver Installation for IBM OS/2	66
Select System Information (optional)	68
Quick Setup (optional)	68
VDIF Files (optional)	69
Advanced Setup (optional)	70
Diagnostics	70
Troubleshooting	71
System Lockup	71
Troubleshooting	71
Windows 95 mach64 enhanced display driver	73
Windows 95 property page problems	73
ATI Video Player Notes	73
Other Problems & Actions	74
C. ATI Player	75
ATI Player	75
Features	75
Playing Audio CDs (Only in window 95)	76
Playing Media Files	77
Playing Interactive Discs (Video CD 2.0)	77
D. Audio Driver	79
First Time Installation	79
For Windows 95	79
For Windows 98	79
First Time Installation	80
For Windows NT 4.0	81

V. Support CD

E. Audio Software	83
Audio Rack Installation	83
Audio Rack Introduction	83
The Command Center	84
Introduction	84
The Command Center Controls	84
The Command Center Display	84
The Miniature Mode	85
Introduction	85
The Miniature Mode Controls	85
The Audio Mixer	86
Introduction	86
The Audio Mixer Controls	86
The Digital Audio Player	87
Introduction	87
The Digital Audio Player Controls	87
The Digital Audio Player Display	87
The MIDI Player	88
Introduction	88
The MIDI Player Controls	88
The MIDI Player Display	88
The Compact Disk Player	89
Introduction	89
The Compact Disk Player Controls	89
The Audio Recorder	90
Introduction	90
The Audio Recorder Controls	90
The Audio Recorder Display	90
Release Notes	91
Disable Eject Button on the CD Player	91
Using AudioRack CD Player as Default CD Player	91
Configuring Playback Mixer	91
F. Software Wavetable	92
Install Software Wavetable (Windows 95/98)	92
G. DMI Utility	93
Desktop Management Interface (DMI)	93
Introducing the ASUS DMI Configuration Utility	93
System Requirements	93
Using the ASUS DMI Configuration Utility	94

A. Video Driver

First Time Installation

When you start Windows for the first time after the installation of your motherboard, Windows 95/98 will detect the onboard video chip (either ATI 3D Rage Pro AGP 2X or ATI 3D Rage IIC AGP, depending on your motherboard) and may attempt to install a driver from its system registry. When prompted to restart, select **No**. Then follow the normal installation procedure later in this section.

IMPORTANT: Selecting **No** for the initial restart prompt is a necessary step because Windows may load an older display driver that is incompatible with the onboard ATI 3D Rage chip. Always use the driver available on the ASUS Support CD or an applicable driver update from your ASUS vendor or from the ASUS web site.

Operating Systems

You should always use the latest operating system and updates when using new hardware in order to ensure full compliancy. For Windows 95, you must use OSR 2.0 or later. For Windows NT 4.0, you must use Service Pack 3.0 or later.

A. Video Driver

Install Video Driver and Utility (Windows 95/98)

Install Video Driver and Utility installs the video driver necessary for your card to have higher performance, resolutions, and special features. You can also install the ATI Player—a software multimedia player which provides full-screen MPEG video playback with excellent color quality, plus a host of advanced multimedia features.

To install the video driver and utility for Windows 95/98

Insert the Support CD that came with your motherboard into your CD-ROM drive or double-click the CD drive icon in **My Computer** to bring up the autorun screen or run **Setup.exe** in the root directory of your CD-ROM drive.

Click **Install Video Driver and Utility**.

The *ATI Installation* dialog box will appear.

Click **Easy Install** to begin the Installation Wizard.

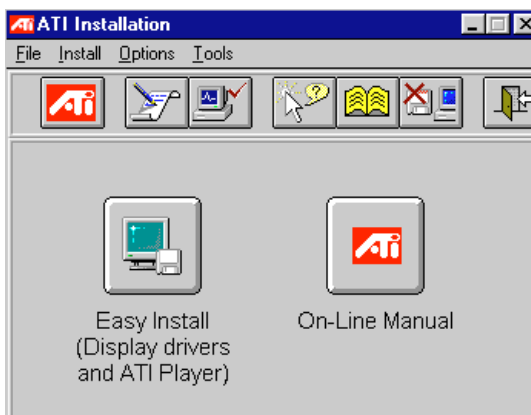
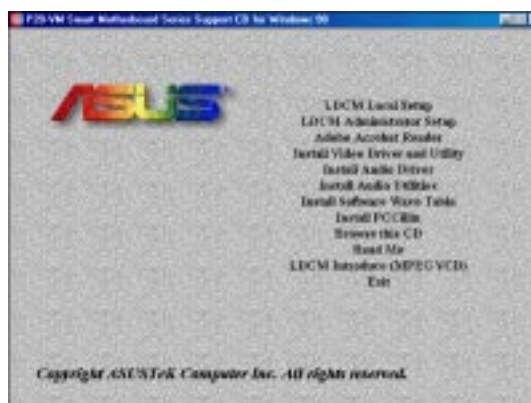

The *ATI Setup* screen will appear.

Click **Next** to proceed with the installation and follow the onscreen instructions to complete the installation.

When prompted to restart your computer, click **Yes**.



A. Video Driver

Display Settings for Windows 95/98

To change resolution, color, and other display properties, either right-click the Windows 95/98 desktop and then choose **Properties**, double-click the **Display** icon in the Control Panel, or right-click the ATI icon in the system tray.

Adjustment Menu

You can adjust the screen output on the monitor from the Adjustment menu. Use the Position and Size arrows to center your screen and make it as large as possible.

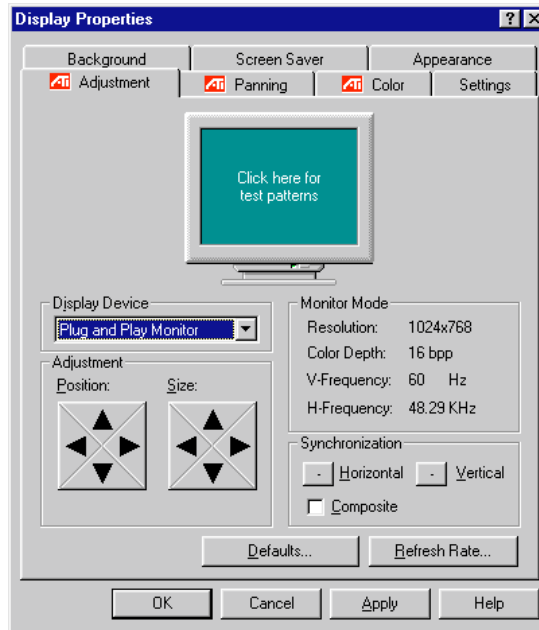

Panning Menu

This allows you to assign hotkeys in the *Value* box for moving your screen up, down, left, right, in, or out in any application. Click **Defaults** to fill in the *Value* box with default values.

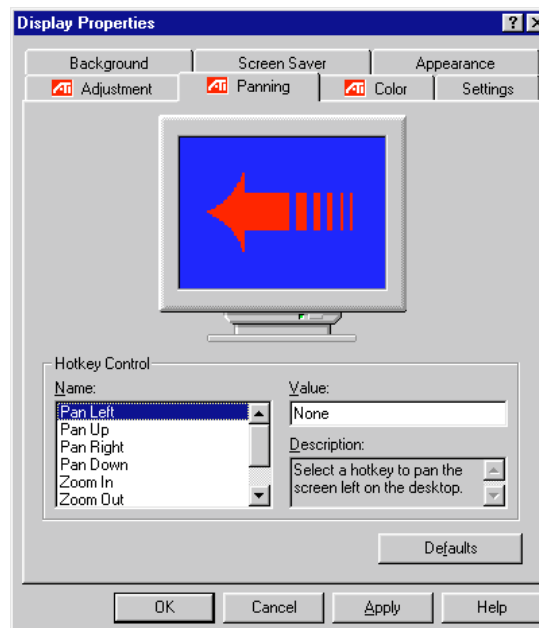

A. Video Driver

Color

This allows you to adjust the Gamma level for your monitor and color levels for Red, Green, and Blue. You can save your settings by clicking **Save As** and typing in a file name. This allows you to recall previously saved settings. Click **Defaults** to restore all settings to their defaults.

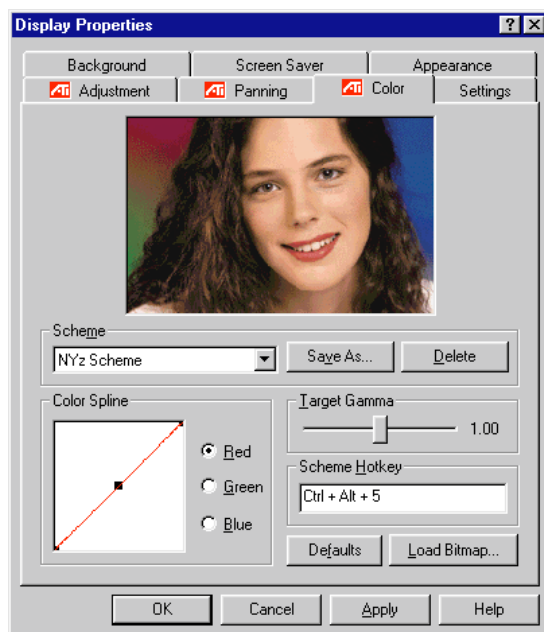

Settings

This allows you to adjust the Color palette, Font size, and Display area. Choose **Center dialog boxes** to keep messages visible, **Enable task bar icon** for easy access to the ATI configuration menus, and **Show settings icon on task bar** for quick resolution changes.

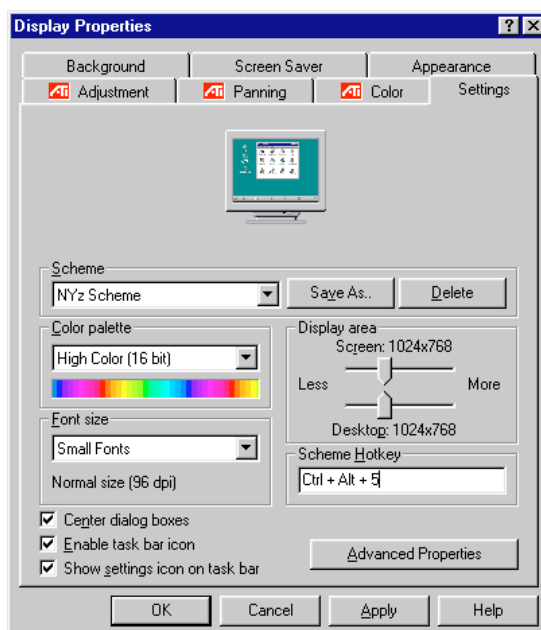

B. Other Video Drivers

Video Driver Installation for Windows NT 4.0

IMPORTANT!

- Windows NT 3.5x does not support AGP cards.
- Before installing the ASUS display driver in Windows NT 4.0, make sure that you have installed the **Windows NT 4.0 Service Pack version 3.0** (available on the Internet at http://www.microsoft.com/isapi/support/bldqpage.idc?ProductPage=q_servpk). Otherwise, the system will hang and will not be able to start up!
- For all the AGP features to be available you must be using Windows NT 5.0 (available in the future)

Installing Video Drivers for Windows NT 4.0

Windows NT will default to standard VGA mode (640x480, 16 colors) when you first start up. Follow the procedure below to install the video driver and player for Windows NT 4.0.

To install the video driver and player for Windows NT 4.0

1. Insert the ASUS Support CD into your CD-ROM drive.
If Windows NT autoruns the CD, skip to step 5.
2. Click **Start**.
3. Select **Run**.
4. Type **D:\ATISSETUP** (where D is your CD-ROM drive).
5. Click **Easy Install** to begin the Installation Wizard.
6. Follow the Wizard's on-screen instructions to complete the installation.

B. Other Video Drivers

Video Driver Installation for IBM OS/2

The ATI OS/2 video driver is to be used for the English version of OS/2 only.

To install ATI video drivers for OS/2 or OS/2 Warp, use the INSTALL program. This program checks the system for possible conflicts, sets the monitor type, and installs the enhanced display driver.

To run the INSTALL program

1. Start OS/2.
2. Check that OS/2 is using a standard VGA driver and no other applications are running.
3. Double-click the **OS/2 System** folder.
4. Double-click the **Command Prompts** folder.
5. Double-click the **OS/2 Full Screen** object.
6. Insert the ASUS Support CD.
7. Type **D:** <Enter> (assuming D is your CD-ROM driver).
8. Type **CD ATI\UTILITY** <Enter>. Type **OS2INST** <Enter>

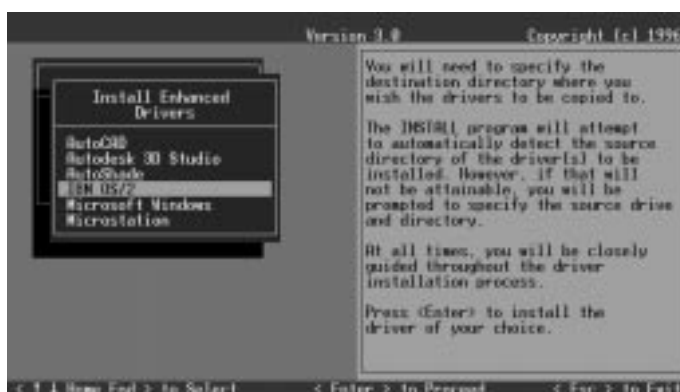

9. Select **Utilities Installation** from the Main Menu.
This copies the utilities onto your hard drive.
 10. Press <Enter> to select the default destination directory.
 11. When prompted, let the INSTALL program make changes to your Autoexec.bat file.
 12. Select **QUICK SETUP**.
You need to select QUICK SETUP to specify a monitor. Proper monitor selection is necessary for correct resolution and refresh rate operation.
 13. Select your monitor from the list.
or
If you do not see your monitor listed, see **Custom Monitor Configuration..**
- After you have selected a monitor, you are ready to copy the enhanced driver files.

B. Other Video Drivers

To copy the driver files

1. Select Drivers Installation from the Main Menu.
2. Select **IBM OS/2** from the list of applications.
3. Select **Install** for the correct version of OS/2.
4. Press <Enter> to select the default destination directory or specify a destination directory for the OS/2 driver files.
5. After the files have been copied, press any key.
6. Press **ESC** to exit.

You are now ready to install the enhanced driver for OS/2.

To install the driver for OS/2

1. In the OS/2 full-screen command prompt, type **DSPINSTL** <Enter>.
2. When the Display Driver Install panel appears, select **Primary Display**. Click **OK** to bring up the driver selection list.
3. Select the latest ATI driver version from the list, and click **OK**.
4. In the Monitor Configuration Selection Utility, select **Install Using Defaults for Monitor Type**, then click **OK**.
5. When the source directory panel appears, choose **Change** and specify the location of the driver. (The default location is C:\MACK_OS2.)
6. Click **SET**.
7. Click **INSTALL**.

B. Other Video Drivers

Select System Information (optional)

The program will check the system for possible conflicts with the device, and display both the device and system configurations in the INFO BOX. In case of a conflict, it will issue a warning and suggest possible corrective actions.

Your onboard video device is PCI Plug-and-Play compatible: your system will automatically allocate system resources and resolve possible conflicts between your Plug-and-Play compatible mach64 accelerator device and other expansion cards.

System Information

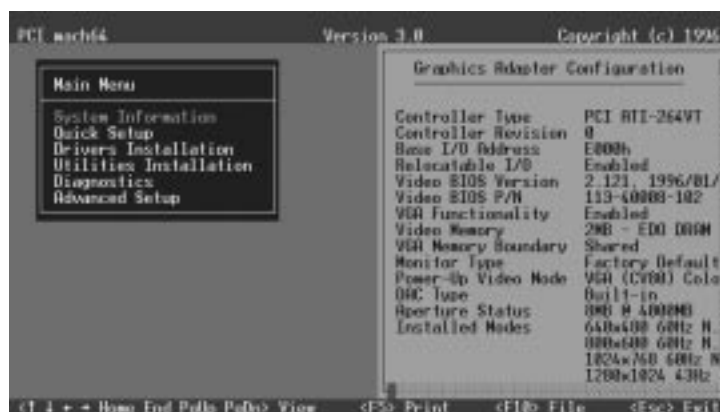

Quick Setup (optional)

Select Quick Setup to configure the accelerator device to work with your monitor. As you highlight each monitor, the display specifications for that monitor type are listed in the INFO BOX. Proper monitor selection is necessary for correct resolution and refresh rate operation. You have four options to choose a correct Monitor Type.

Selecting Your Monitor Type: Factory Default/Apple.../IBM.../MIT.../NEC.../VESA-Std.../Generic.../Read VDIF.../Custom...

Select Read VDIF... If you have a VDIF file for your monitor and wish to use its parameters to automatically configure the mach64. Additional VDIF details are provided later in this chapter, in the section: *VDIF Files*

Select Custom... if none of the above applies to you, or you wish to manually configure the settings. Please refer to the information provided later in this chapter in the section: **Custom Configuration**

Notes On Refresh Rates:

- A higher refresh rate reduces screen flicker, and therefore reduces eye strain. Not all refresh rates are supported at all color depths. Refer to the features section for specifications of your ASUS 264 Series Device.
- The resolution used by your software application is independent of the refresh rate. Resolution depends on the installed software driver and selected display mode.

B. Other Video Drivers

VDIF Files (optional)

VDIF files are VESA Display Information Format files. They contain all the necessary configuration parameters for getting optimal resolution and refresh rate operation from the specified monitor. Consult your monitor manufacturer for availability of VDIF files.

If you have a VDIF file for your monitor, select it. The **INSTALL** program will read the VDIF file and automatically configure the device to properly work with your monitor.

Procedure:

1. Start the **INSTALL** program.
2. Select **Quick Setup** and press <Enter>.
3. Insert into a floppy drive the disk containing the VDIF file.
4. Select **READ VDIF...** and press <Enter>.
5. Type in the location of the VDIF file (typically A: or B:). **INSTALL** will read the file and configure the device to support your monitor according to the VDIF specification.

Custom Configuration

If your monitor is not listed in the Monitor Selection Menu, or you are not using DDC or VDIF, you can set up display modes, i.e., resolutions and refresh rates, on the device using the Custom... option. This option is useful even if you had selected a monitor from the list. For example, you can modify the screen centering or refresh rate on one resolution, and not change the other resolutions.

Procedure:

1. Start the **INSTALL** program.
2. Select **Quick Setup** and press <Enter>.
3. Select **Custom...** and press <Enter>.
4. Pick a resolution, then a refresh rate. You will see a box outline.

WARNING: Using the wrong refresh rate may permanently damage your monitor. For more information, please refer to the manual.

NOTE: An incorrect Monitor Type setting may damage your monitor. Review your monitor specifications before making a selection from the Monitor Selection Menu. Do not exceed the monitor specifications. Using a refresh rate (i.e., vertical frequency) that is higher than specified may damage your monitor. The manufacturer will not be liable for any damage caused by incorrect settings. Consult your monitor manual to determine the highest refresh rate for each resolution that your monitor supports. A scrambled screen indicates your monitor is not capable of the selected display mode. In which case, you should immediately press <Esc> to exit.

TIP: If the monitor produces a scrambled display, try a lower refresh rate. If it is already at the lowest refresh rate, set that resolution to Not Supported.”

5. Adjust the size and position of the box outline. Press <Enter> to accept.
6. Repeat steps 2 and 3 until you are satisfied with the box outline for all the resolutions. When finished, remember to exit and save the settings.

B. Other Video Drivers

Advanced Setup (optional)

If you wish to fine tune its settings for your monitor and system type, select Advanced Setup from the Main Menu. On-screen context sensitive help is displayed as you highlight each Advanced Menu item.

WARNING! The Advanced Configuration option allows you to use certain features that may add additional performance to your device. However these options may not be compatible with your system. If problems appear after an advanced option is changed, returning the device to factory defaults will rectify the situation.

Factory Defaults

The device can be reset to factory defaults by pressing <Shift>+<F7>.

Saving Your Configuration

Once you have finished configuring the necessary parameters described above, save them by pressing <F10>.

Diagnostics

All installed graphics modes in the mach64 accelerator can be viewed and tested, by running the INSTALL program from the DOS prompt, or by running a diagnostics program called M64DIAG.EXE. Do not run it in a windowed or full-screen DOS box. In the INSTALL program, select Test Graphics Adapter from the Diagnostics... option of the Main Menu. The Test Graphics Adapter menu has the following options:

- VGA Tests ...
- Accelerator Tests ...

Any time you suspect there is a problem, especially during installation, run the above tests. The information provided in this appendix will enable you to solve most problems.

B. Other Video Drivers

Troubleshooting

System Lockup

- If you are using a memory manager such as QEMM or 386MAX you need to modify the command line in the CONFIG.SYS file so that the address of the graphics device video BIOS, C000 - C7FF, is excluded. For example, add “EXCLUDE = C000 - C7FF” to the command line.
- Remove all unnecessary boards.
- Disable shadow RAM.
- Ensure that the board is seated correctly and that the device has been installed using the proper utilities.
- Try the device in a different system and reset to factory defaults using the INSTALL program. If the device works in another system, the problem is likely due to incorrect configuration.

Troubleshooting

Because a typical computer system consists of many different parts, difficulties may arise from a combination of items, from software or hardware installation, to monitor compatibility. Listed below are several checks you can make to help determine what the problem is.

Test Patterns OK; Applications Do Not Sync

The wrong monitor type has been selected. Change the settings in the INSTALL program.

Windows Driver Not Installing Properly

Windows must be running in 386 Enhanced Mode. Incompatible memory managers may prevent Windows from starting in enhanced mode. If this occurs, remove the offending driver or memory manager.

Windows NT 4.0 driver cannot pass “Test VGA.”

Please bypass “Test VGA” then load ATI drivers after completing installation.

AutoCAD Driver Not Installing Properly

If using a 386, ensure that AutoCAD has been configured for the appropriate ADI driver. The protected mode driver requires extended memory.

Error Codes and Messages

Problems and solutions for some common errors found by the test program are provided for your reference as follows:

B. Other Video Drivers

Memory aperture test failure or Diagnostics program locks or Reboots during aperture test

If you receive an error message indicating that the memory aperture location is conflicting with your system memory, restart the INSTALL program as follows: INSTALL APMAP <Enter>. Now when you enable Memory Aperture, you must select a location above but not overlapping System Memory (S), BIOS (B) or Reserved (R) locations. Not applicable for ISA cards.

Desired resolution is disabled and displayed in gray

A mode displayed in gray means that the BIOS is told this mode is not available, based on the device configuration. Reinstall using custom monitor selection.

Menu item is disabled and displayed in gray

The test program has determined that the mode or test is not available under the current configuration. Aperture tests are not available if the aperture is disabled, and CRT mode and pixel depth are determined by current installation, DAC type, memory size, and memory type.

Adapter not detected

This message should only occur when a mach64 ASIC is not detected. If this message occurs and a mach64 board is present, it may indicate an I/O conflict, conflicts between the Extended Memory Manager (EMM) and the video ROM. Try removing all other boards from the system and booting from a plain DOS disk. Try excluding the video BIOS address (C0000-C7FFF) from the memory manager. Refer to the documentation furnished with the memory manager software for information.

Any FIFO test error

The effects of a bad command FIFO should be visible. (e.g., the screen does not come up, or it displays garbage.)

Quick memory test error

Run Detailed RAM Test to confirm the error and identify the address of the error.

Detailed memory test error.

Run Detailed RAM Test several times to confirm the error and take notes of any messages and error codes.

DAC LUT test failure.

An error has occurred while testing the DAC LookUp Table. The problem should be visible on the top color bar of any 8bpp mode.

ROM checksum error.

An error has been detected in the ROM.

Draw sequence failure.

An error has occurred in the draw engine. If the error is intermittent, it might indicate a marginal RAM failure. The effects of this failure may not be immediately apparent.

B. Other Video Drivers

Windows 95 mach64 enhanced display driver

The Windows 95 mach64 enhanced display driver is capable of using monitor timing data contained within Windows 95. This data is selected by configuring a monitor type at Windows 95 installation time or via the “Settings” page of the display properties sheet.

The Windows 95 mach64 enhanced display driver may incorrectly interpret Windows 95 monitor timing data for some older monitors which require interlaced modes. This may cause some options to be disabled. A solution to this problem is to select one of the “(Standard monitor types)” available via the settings page of the display properties sheet.

If you change the selected monitor type via the “Settings” page of the display properties sheet the new timing data may not take effect until after restarting Windows 95. A solution to this problem is to always restart Windows 95 after changing the monitor type.

In Windows 95, display drivers can be installed via the “Add New Hardware” wizard. This is not recommended because when the Windows 95 mach64 enhanced display driver is installed via the “Add New Hardware” wizard the “Settings” page does not get installed into the mach64 display adapter property sheet.

Windows 95 property page problems

While adjusting monitor settings in the Adjustment page of the Display Properties sheet, your monitor could become unreadable. If this occurs, press the ESC key to return to your previous monitor settings.

ATI Video Player Notes

Why can my Video Player not execute in Windows 3.1 ?

The Video Player needs at least 600K DOS CONVENTIONAL MEMORY. You can try to close some programs to acquire more memory to use. If it still happens, return to DOS and run “MEMMAKER” in your DOS directory to modify your memory configuration. Quitting some DOS TSRs (Terminate and Stay Resident) programs also helps.

After installing Xing MPEG Player, my ATI Video Player can not play Video CD even standard MPEG files.

Xing MPEG Player and ATI Video Player can not be installed together. They conflict with each other. The previously installed player will work abnormally. You can re-install ATI Video Player to recover it.

Why can I not use the TV output function in Windows 95?

You need to make sure that your resolution is 800x600 or under and refresh rate equal to or less than 60Hz in NTSC and 50Hz in PAL.

B. Other Video Drivers

Other Problems & Actions

My monitor is not capable of high resolution or refresh rate.

It depends on the display characteristics of your monitor. Consult your monitor documentation for the proper configuration.

After installing the driver, Windows 95 doesn't prompt me to restart and the driver still doesn't work after I restart my computer.

You may have installed similar drivers before. Try the following steps to install:

1. Right-click **My Computer** on the desktop.
2. Select **Properties**. The **System Properties** dialog box appears.
3. Click the **Device Manager** tab. Be sure that **View devices by type** is selected.
4. Double-click **Display adapters**. If **Display adapters** does not appear, jump to step 8 and continue.
5. The name of your device will be listed in the box. Double-click it.
6. The properties box of your device appears. Click the **Driver** tab.
7. Click **Change Driver...** and follow the installation steps.
8. Click **Other devices**. Your device should be listed.
9. Click the name of your device to bring up the properties box of your device. Select the **Driver** tab.
10. Click **Change Driver...** and follow the installation steps.

After installation and restarting, Windows 95 informs me that the display setting is still incorrect.

There may be a conflict between a previous and the current display drivers. This is caused by the incomplete removal of the previous display driver. Try the following steps to remove it:

1. Right-click **My Computer** on the desktop.
2. Select **Properties**. The **System Properties** dialog box appears.
3. Click the **Device Manager** tab. Be sure that **View devices by type** is selected.
4. Double-click **Display adapters**.
5. You will find two (or more) conflicting adapters.
6. Disable all previous adapters by selecting them and clicking **Remove**.
7. Close Device Manager and restart Windows 95.
8. Your display driver should work correctly this time.

C. ATI Player

ATI Player

ATI Player and control panel (Win3.1x and Win95)

If VIDEO drivers are installed, for playing video clips, the ATI Player icon will appear in the DeskTop. Double click on this icon to bring up the Video Screen as shown here: (Detailed button definitions are shown when holding the cursor over the individual buttons for a few seconds.)

The Task Control Panel

The Task control panel indicates what mode the player is in and what it's doing. (Your Task control panel may not look exactly like the illustration-only installed or available features will have controls.)

Under win31 environment



Under Win95 environment

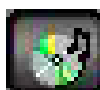
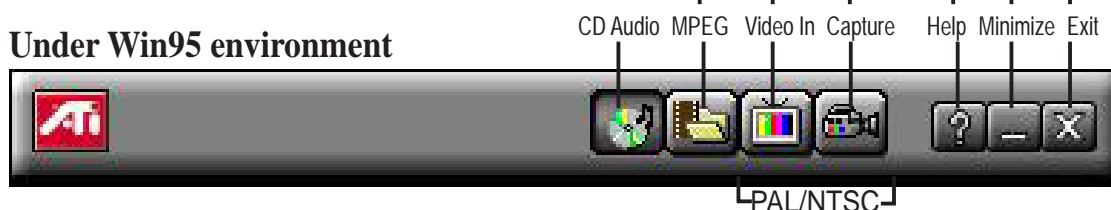

CD Audio—Play standard audio CDs (only in Windows 95)



MPEG Playback—Play MPEG and AVI video files



Video In (Tuner button)—Display live video sources
(available only on video model)



Capture—Capture still images, video sequences, or audio-only
(available only on video model)

Features

The question mark on top right of the Video Screen allows inspection into each button on the control panel. Click on the “?” then on a button that you would like to know about.

C. ATI Player

Playing Audio CDs (Only in window 95)



Click the Audio CD button in the Task control panel to switch to Audio CD mode



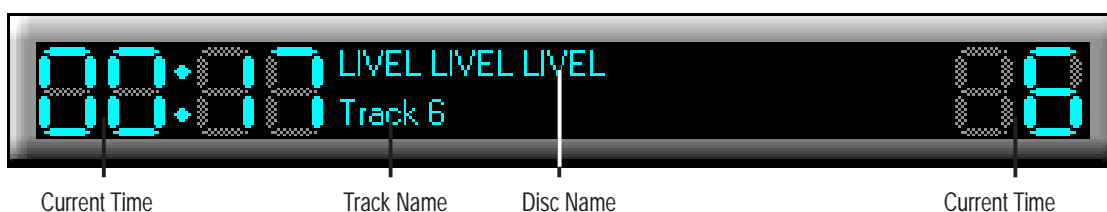

The Audio CD player has its own control panel for controlling the audio CD playback. You can use the Audio CD panel to play standard audio CDs. Advanced features such as Random play, Intro play, which plays the first ten seconds of each track, and Loop play are available.



The Audio CD player has its own display.

To play an audio CD

1. Insert the audio CD into your CD-ROM drive.
2. In the Audio CD panel, click the Setup Dialogs button 
3. Click the Disc Info tab.
4. From the Available Tracks list, add or remove tracks as desired.
The Play List displays your current selections.
5. Click OK.
6. In the Audio CD panel, click the Play button 

The Audio CD player uses Windows 95 standard INI file to store disc names, track names, and the play list. You can use the Setup dialog to enter the name of the artist and the disc.

C. ATI Player

Playing Media Files



Click the MPEG Playback button in the Task control panel to switch to playback mode.



The Control panel changes to the Playback panel.

To view/hide the Playback panel in Full Screen mode, press F2.

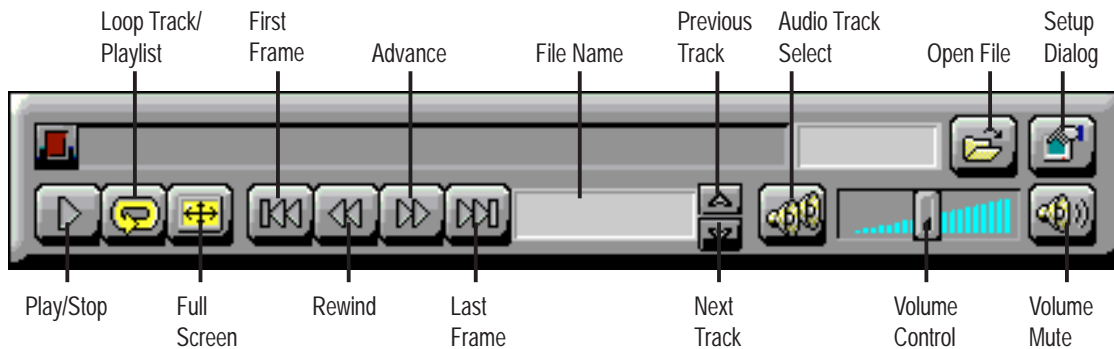

You can use the Media Playback panel to play the following media files:

- MPEG-1 digital audio and video, including Karaoke?including dual-channel audio, CDi, Games, and reference application titles
- *.AVI video files

To play a file

1. In the Playback panel, click the File Open button
2. Select a file from the list.
3. Click Add, then click OK.
4. Click the Play button
5. The file plays in the Display panel.

Playing Interactive Discs (Video CD 2.0)

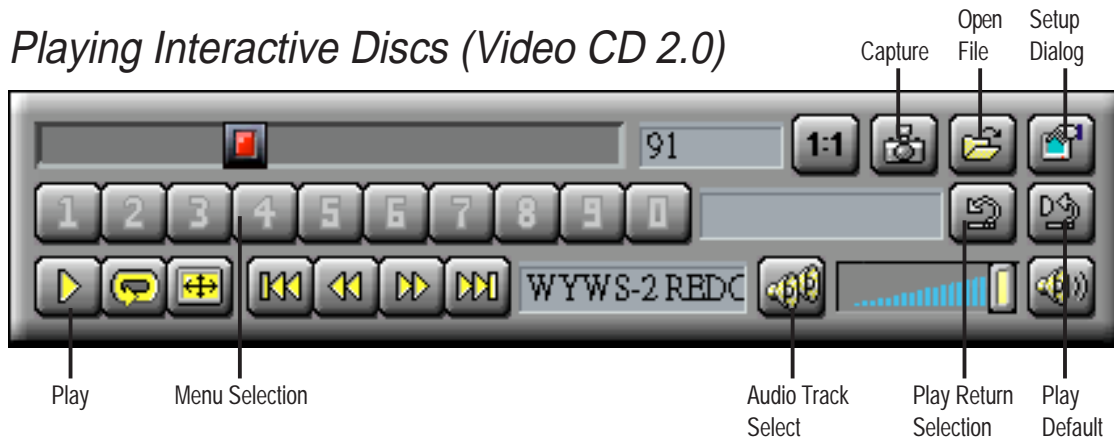

When playing Video CD 2.0 discs, the Control panel changes to this interactive panel.

C. ATI Player
Windows 95/3.x

(This page was intentionally left blank)

D. Audio Driver

First Time Installation

When starting Windows 95/98/NT 4.0, the operating system will automatically detect the ESS Solo-1 PCI Audio Driver.

For Windows 95

1. When the *New Hardware Found* screen prompts for a driver, select **Driver from disk provided by hardware manufacturer** and insert the ASUS Support CD into your CD-ROM drive.
2. Click **OK**.
3. Click **Browse**.
4. Locate the **D:\audio\w95** folder (where D is your CD-ROM Drive) and click **OK**.
5. Click **OK** again and the driver files will be copied.
6. Click **Yes** to restart the computer.

For Windows 98

1. When the *Add New Hardware* screen prompts you for a driver, select **Display a list of all the drivers in a specific location, so you can select the driver you want** and click **Next**.
2. Select **Sound, video and game controllers** and click **Next**.
3. Click **Have Disk**.
4. Insert the ASUS Support CD into your CD-ROM drive.
5. Click **Browse**.
6. Locate the **D:\audio\w95** folder (where D is your CD-ROM Drive) and click **OK**.
7. Click **OK** again and the driver files will be copied.
8. Click **Yes** to restart the computer.

D. Audio Driver

First Time Installation

When starting Windows 95/98/NT 4.0, the operating system will detect that you have a new PCI Multimedia Device.

Click **Next** when the *Update Device Wizard* screen appears.



Click **Other Locations** to direct the wizard to the audio driver files.



Click **Browse** to locate the `\audio\Win95` folder for Windows 95/98 or the `\audio\Nt40` folder for Windows NT on the ASUS Support CD.

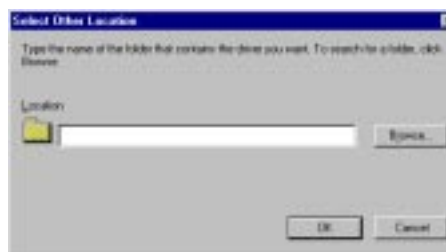

Click **OK** to select the folder.

Click **OK** and your device and driver location will be shown. Click **Finish**.



You will be prompted to insert the ASUS Support CD. Click **OK**.



Click **Browse** and locate the `\audio\Win95` (or `\audio\Nt40`) folder on the ASUS Support CD again.

Follow the self-explanatory instructions to finish your driver installation.

D. Audio Driver

For Windows NT 4.0

1. Run the Windows NT “Multimedia” program located in **Control Panel**.
(**Start->Settings->Control Panels->Multimedia**)
2. Click the **Devices** tab.
3. Select **Audio Devices** under Multimedia Devices.
4. Click **Add**.
5. Select **Unlisted or Updated Driver** under List of Drivers.
6. Click **OK**.
7. When Windows prompts you for the driver location, click **Browse**.
8. Locate the **D:\audio\Nt40** folder (where D is your CD-ROM Drive).
A list of audio drivers will be displayed.
9. Select the driver for your audio chipset and click **OK**.
Windows will prompt you to restart.
10. Click **OK** to restart the computer.

(This page was intentionally left blank)

E. Audio Software

Audio Rack Installation

Reinsert your CD or double click on your CD drive icon in My Computer to bring up the autorun screen or run Setup.exe in the root directory of the CD. Click **Install Audio Utilities** from the main menu.

Audio Rack Introduction

The *AudioRack32* enables you to take advantage of your computer's audio capabilities with all of the controls conveniently in one compact space. You can play audio CDs, wave files (in .WAV and .AUD formats), and MIDI files (in .MID and .RMI formats). With the multisource Audio Mixer, you can blend these sources with line-in and microphone sources any way you choose. You can then record your creations as wave files and edit them with the Audio Recorder.

The *AudioRack32* has six main parts:

- Command Center—customizes the appearance of the *AudioRack32*.
- Audio Mixer—controls the volume and balance of the *AudioRack32* devices.
- Digital Audio Player—plays and records files in the .WAV format.
- MIDI Player—enables you to play MIDI files.
- Compact Disk Player—enables you to play audio CDs on a CD-ROM drive.

In addition, the *AudioRack32* has a miniature mode enabling you to control the *AudioRack32* while using minimal screen space.

The Audio Recorder is a separate application from the *AudioRack32*. It can be used to add effects and edit files recorded with the Digital Audio Player or by the Audio Recorder itself. The Audio Recorder can be launched from the *AudioRack32*'s Digital Audio Player or on its own.



E. Audio Software



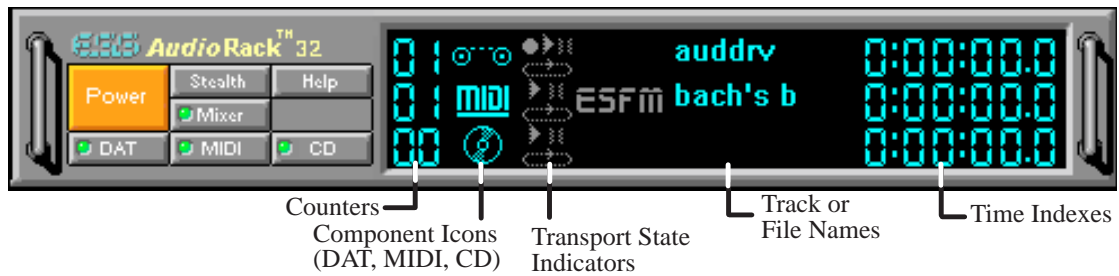



The Command Center



Introduction

The Command Center controls which parts of the *AudioRack32* are displayed. You can display or hide any part of the *AudioRack32* you choose, customizing its appearance to suit your needs or desires. It also displays information on the status of the different audio components.

The Command Center Controls

-  closes the *AudioRack32* window.
-  enables the Miniature mode, minimizing the *AudioRack32* display.
-  displays or hides the Digital Audio Player.
-  accesses On-line Help.
-  displays or hides the Compact Disk Player.
-  displays or hides the Audio Mixer.
-  displays or hides the MIDI Player.

The Command Center Display

Counter: shows you which track or file in the playlist the component is playing.

Component Icon: is displayed when the associated component is shown and is not displayed when the component is hidden.

Transport State Indicator: shows the state of a component. It indicates when the component is playing, paused, has the Auto Repeat enabled, or in the case of the Digital Audio Player, is recording.

Track or File Name: shows the name of the current track or file in the playlist.

Time Index: displays the amount of time elapsed for the track or file in hours, minutes, seconds, and tenths of a second.

E. Audio Software





The Miniature Mode



Introduction

The Miniature mode is designed to give you full control of the *AudioRack32* while using a minimum of space. You are able to effectively use the *AudioRack32* and still have enough room on your desktop to run other applications. In the Miniature mode, you can play, pause, stop, and control the master volume of the *AudioRack32*.

The Miniature Mode Controls

-  stops currently playing tracks or files of active components.
-  plays currently loaded tracks or files of active components.
-  pauses currently playing tracks or files of active components.
-  calls a popup menu where you can restore the *AudioRack32*, invoke the **Always on Top** command, select active components (DAT, MIDI, or CD), or exit the *AudioRack32*. The Stop, Pause, and Play buttons affect components that are currently active.



 controls the master volume.

E. Audio Software

The Audio Mixer



Introduction

The Audio Mixer has two modes: Playback mode and Record mode. You can use these two modes to fully control which of your audio sources you are listening to or recording, how loud each of those sources are and how they are balanced. Each audio source has its own module with mute, balance and volume controls.

In addition, the Audio Mixer provides special effects controls for chorus, reverb, treble, bass, and 3-D effects.

The Audio Mixer Controls

The two Playback and Record toggle buttons are used to switch between Playback mode and Record mode.

The Effects toggle button switches the display to the effects panel where you can use the buttons to enable and disable effects and the sliders to control the amount of the effect.

There are a number of audio source modules displayed on the Audio Mixer. The exact number displayed depends on the capabilities of your hardware. Each module has three controls:



a slider to adjust the balance

a slider to adjust the volume

a button for muting

Modules that your hardware may provide for are: Master, Line, Wave, Mic, CD, MIDI, and AuxB.

E. Audio Software















The Digital Audio Player



Introduction

The Digital Audio Player enables you to play, record, and compress sound as .WAV files. In addition, you can play .AUD files. The .WAV files use PCM, which is the Windows' audio file format. The .AUD format uses ESPCM' compression to produce an audio file. Files are written directly to your hard disk as you record, enabling you to record very large files. Your only limitation is the amount of free space on your hard disk. The voice activation feature is useful for recording any kind of intermittent audio. The Digital Audio Player provides a choice of linear PCM (8 or 16 bit) recording. Note that you have additional options using the Audio Recorder, which is invoked by the **Edit** button.

The Digital Audio Player Controls

-  starts recording to your hard disk.
-  goes to the end of the wave file or to the next file in the current playlist.
-  plays the wave file currently loaded.
-  enables or disables the Auto Repeat.
-  activates or deactivates the Pause
-  opens the Audio Recorder window.
-  stops the file currently playing.
-  opens the Set Playlist dialog box.
-  goes back one second in the wave file.
-  starts a new file by opening the New Options dialog box.
-  goes forward one second in the wave file.
-  brings up the Open file dialog box in order to load a file into the Digital Audio Player.
-  goes to the beginning of the wave file or to the previous file in the current playlist.
-  saves an audio file.

The Digital Audio Player Display

 The Level Meter displays the output from the left (top) and right (bottom) channels when a wave file is played.

 By clicking on the image of the tape deck, you can display information about the file currently loaded in the Digital Audio Player. The display tells you the file name, size, number of bits per sample, sample rate, and whether the file was recorded in stereo or mono. Click again to return to the image of the tape deck.

audrv.wav
47 Kbytes
16 bit 22 kHz
Mono

E. Audio Software









The MIDI Player



Introduction

The MIDI Player enables you to play MIDI files with the .MID or .RMI file extensions. These MIDI (Musical Instrument Digital Interface) files can be produced by sequencer programs and then played back using the MIDI Player. You can also mix MIDI files with other audio sources. Or you can compile MIDI files in a playlist and play them back in any order you choose.

The MIDI Player Controls

-  plays the MIDI file currently loaded.
-  goes back one file in the playlist.
-  activates or deactivates the Pause
-  goes forward one file in the playlist.
-  stops the file currently playing.
-  enables or disables the Auto Repeat.
-  goes back one second in the MIDI file.
-  opens the Set Playlist dialog box.
-  goes forward one second in the MIDI file.

The MIDI Player Display

By clicking on the image of the floppy drive, you can display the length and name of the current MIDI file in the playlist. Click the display to return to the image of the floppy drive.

 The MIDI Player has an indicator to show when you are listening to ESFM. When the ESFM light to the left of the playlist button is lit, the MIDI Player is using ESFM synthesis. ESFM performs superior-quality music synthesis compared to that of traditional FM, producing richer timbre and greater depth of instrument voices. **FM synthesis is a lower quality technology compared with Wave table synthesis. This card supports Wave table synthesis therefore ESFM is not supported on this card.**

E. Audio Software











The Compact Disk Player



Introduction

If you have a CD-ROM drive, you can play audio CDs. Check your hardware manual about setting up CD audio hardware and drivers. The Compact Disk Player uses intelligent CD playlist management: The Compact Disk Player maintains a record of each CD you play. It remembers the last playlist you used with each CD and loads that playlist automatically whenever you insert that CD.

The Compact Disk Player Controls

-  plays the MIDI file currently loaded.
-  goes back one file in the playlist.
-  activates or deactivates the Pause
-  goes forward one file in the playlist.
-  stops the file currently playing.
-  enables or disables the Auto Repeat.
-  goes back one second in the MIDI file.
-  opens the Set Playlist dialog box.
-  goes forward one second in the MIDI file.
-  ejects the CD from the CD-ROM drive.

E. Audio Software

The Audio Recorder

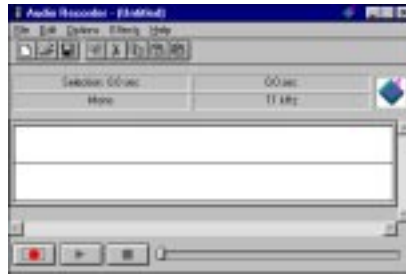













Introduction

The Audio Recorder enables you to record, compress, store, and play back voice, music, and other sound. It provides settings for sound attributes such as mono/stereo, compression level, and sampling rate. You can use it to embed sound objects in documents created in applications that support object linking and embedding (OLE).

The Audio Recorder's edit, record, and playback capabilities are compatible with the Windows Sound Recorder and other recorders that record and play back in the PCM format. Like the Digital Audio Player, the Audio Recorder can record and play back .WAV and .AUD files. The Audio Recorder allows a choice of compression from low, medium, and high ESPCM and ADPCM.

The Audio Recorder Controls

-  starts a new audio file.
-  inserts the Clipboard audio at the cursor or replaces the selected portion.
-  opens an audio file.
-  mixes the Clipboard audio with the audio beginning at the cursor.
-  saves an audio file.
-  starts recording.
-  reverses the last change you made to the current audio file.
-  plays the currently loaded audio file.
-  removes the selected portion of the audio file and stores it on the Clipboard.
-  stops the file currently playing or recording.
-  copies the selected audio portion to the Clipboard without removing it.
-  determines the cursor position on the waveform.

The Audio Recorder Display



The four text boxes under the tool bar display the length in seconds of the selected part of the currently loaded file, the total length in seconds of the current file, whether the file is in stereo or mono, and the sampling rate in kilohertz.

To the right of the text boxes is a box displaying the icon associated with the particular file. If a file has no icon associated with it, it is given a default icon.

E. Audio Software

Release Notes

This information is provided for convenience only. Information here is subject to change without prior notice. View the installation CD for any updated information in Readme text files. The AudioRack also provides detailed online help (click the **Help** button on the “Command Center”)

Disable Eject Button on the CD Player

Under the Windows directory in the file “auddrive.ini”, there is a string “DisableEjectButton=0” under the [cdplayer] section. If you would like to disable EJECT button on the CD player, you can change the value from 0 to 1. You need to close AudioRack and launch it again to make the new settings take effect.

Using AudioRack CD Player as Default CD Player

During installation, you will be asked if you want to use AudioRack CD player as the default CD player. Normally Windows 95 CD player is the default and will automatically run when an audio CD is inserted into the CD-ROM. If you answer “Yes”, the installation program will overwrite the value of the key [HKEY_CLASSES_ROOT]\AudioCD\shell\play\command in the registry. You may switch back to Windows 95 CD player by resetting this key value.

Configuring Playback Mixer

The onboard PCI audio device offers eight inputs for the playback mixer, including “Line”, “Wave”, “CD”, “Synth”, “Aux A”, “Aux B”, “Mic”, and “Mono In”. AudioRack can only display six of them at a time. You may configure the settings by modifying the file “auddrive.ini” in the Windows directory. Under the section [MixerRak], you can enable or disable the display of each input by setting its corresponding binary value to 1(enable) or 0(disable).

F. Software Wavetable

Install Software Wavetable (Windows 95/98)

Insert the ASUS Support CD into your CD-ROM drive or double-click the CD drive icon in **My Computer** to bring up the autorun menu or run **Setup.exe** in the root directory of your CD-ROM driver. This will bring up the main menu.

Click **Install Software Wave Table**.

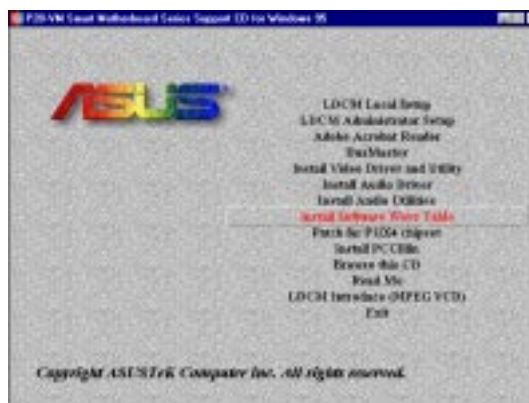

Select **Install ESS Software Wavetable** and click **Next**.



When Setup has finished installing all the necessary files on your computer, it will prompt you to restart your computer.

Select **Yes, I want to restart my computer now** and then click **Finish** to restart your computer and complete setup.



G. DMI Utility

Desktop Management Interface (DMI)

Introducing the ASUS DMI Configuration Utility

This motherboard supports DMI within the BIOS level and provides a DMI Configuration Utility to maintain the Management Information Format Database (MIFD). DMI is able to auto-detect and record information pertinent to a computer's system such as the CPU type, CPU speed, and internal/external frequencies, and memory size. The onboard BIOS will detect as many system information as possible and store those collected information in a 4KB block in the motherboard's Flash EPROM and allow the DMI to retrieve data from this database. Unlike other BIOS software, the BIOS on this motherboard uses the same technology implemented for Plug and Play to allow dynamic real-time updating of DMI information versus creating a new BIOS image file and requiring the user to update the whole BIOS. This DMI Configuration Utility also allows the system integrator or end user to add additional information into the MIFD such as serial numbers, housing configurations, and vendor information. Those information not detected by the motherboard BIOS and has to be manually entered through the DMI Configuration Utility and updated into the MIFD. This DMI Configuration Utility provides the same reliability as PnP updating and will prevent the refreshing failures associated with updating the entire BIOS.

System Requirements

The DMI Configuration Utility (DMICFG2.EXE) must be used in real mode in order for the program to run, the base memory must be at least 180K. Memory managers like HIMEM.SYS (required by windows) must not be installed. You can boot up from a system diskette without AUTOEXEC.BAT and CONFIG.SYS files, "REM" HIMEM.SYS in the CONFIG.SYS, or press <F5> during bootup to bypass your AUTOEXEC.BAT and CONFIG.SYS files.

G. DMI Utility

Using the ASUS DMI Configuration Utility

NOTE: The following screen displays are provided as examples only and may not reflect the screen contents on your system.

Edit DMI (or delete)

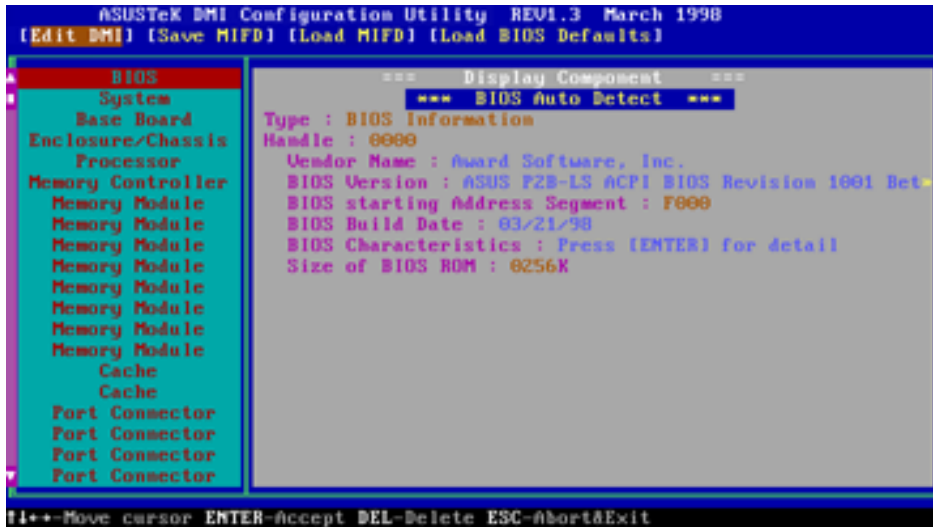

Use the ←→ (left-right) cursors to move the top menu items and the ↑↓ (up-down) cursor to move between the left hand menu items. The bottom of the screen will show the available keys for each screen. Press enter at the menu item to enter the right hand screen for editing. “Edit component” appears on top. The reversed color field is the current cursor position and the blue text are available for editing. The orange text shows auto-detected information and are not available for editing. The blue text “Press [ENTER] for detail” contains a second pop-up menu is available, use the + - (plus-minus) keys to change the settings. Enter to exit *and save*, ESC to exit *and not save*.

If the user has made changes, ESC will prompt you to answer Y or N. Enter Y to go back to the left-hand screen *and save*, enter N to go back to left-hand screen and *not save*. If editing has not been made, ESC will send you back to the left hand menu without any messages.

Notes

A heading, *** BIOS Auto Detect ***, appears on the right for each menu item on the left side that has been auto detected by the system BIOS.

A heading, *** User Modified ***, will appear on the right for menu items that have been modified by the user.



G. DMI Utility

Save MIFD

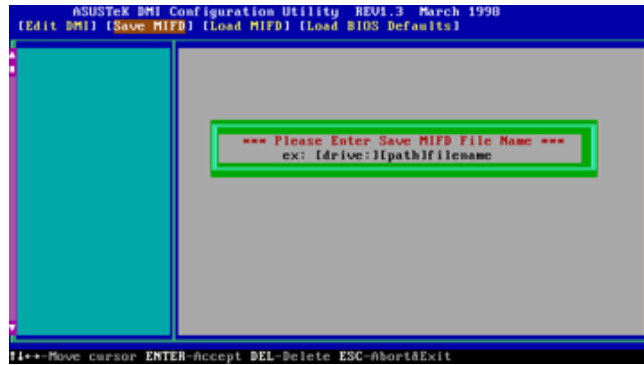

You can save the MIFD (normally only saved to flash ROM) to a file by entering the drive and path here. If you want to cancel save, you may press ESC and a message “Bad File Name” appears here to show it was not saved.

Load MIFD

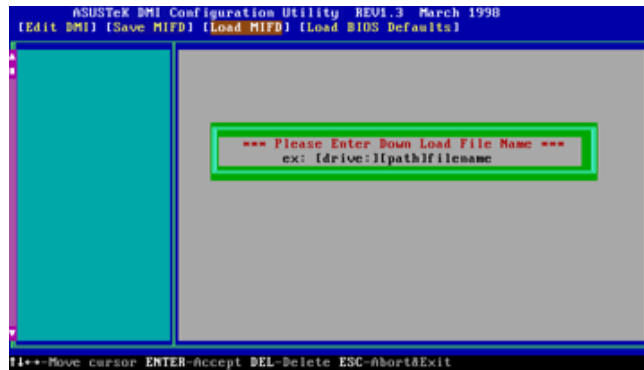

You can load the disk file to memory by entering a drive and path and file name here.

Load BIOS Defaults

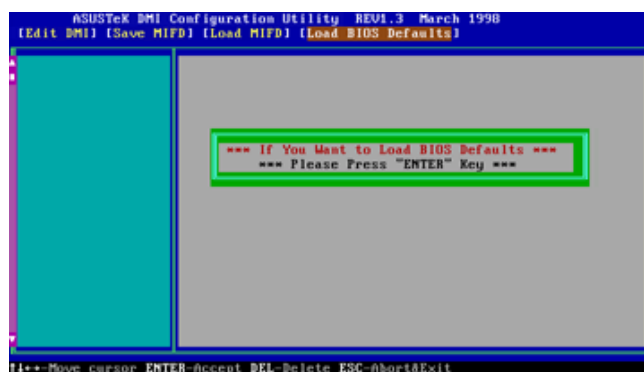

You can load the BIOS defaults from a MIFD file and can clear all user modified and added data. You must reboot your computer in order for the defaults to be saved back into the Flash BIOS.

(This page was intentionally left blank)