

**ASUS<sup>®</sup> C-PKND**  
Dual Pentium<sup>®</sup> II CPU Card

**USER'S MANUAL**

# USER'S NOTICE

---

No part of this manual, including the products and softwares described in it, may be reproduced, transmitted, transcribed, stored in a retrieval system, or translated into any language in any form or by any means, except documentation kept by the purchaser for backup purposes, without the express written permission of ASUSTeK COMPUTER INC. ("ASUS").

ASUS PROVIDES THIS MANUAL "AS IS" WITHOUT WARRANTY OF ANY KIND, EITHER EXPRESS OR IMPLIED, INCLUDING BUT NOT LIMITED TO THE IMPLIED WARRANTIES OR CONDITIONS OF MERCHANTABILITY OR FITNESS FOR A PARTICULAR PURPOSE. IN NO EVENT SHALL ASUS, ITS DIRECTORS, OFFICERS, EMPLOYEES OR AGENTS BE LIABLE FOR ANY INDIRECT, SPECIAL, INCIDENTAL, OR CONSEQUENTIAL DAMAGES (INCLUDING DAMAGES FOR LOSS OF PROFITS, LOSS OF BUSINESS, LOSS OF USE OR DATA, INTERRUPTION OF BUSINESS AND THE LIKE), EVEN IF ASUS HAS BEEN ADVISED OF THE POSSIBILITY OF SUCH DAMAGES ARISING FROM ANY DEFECT OR ERROR IN THIS MANUAL OR PRODUCT.

Products and corporate names appearing in this manual may or may not be registered trademarks or copyrights of their respective companies, and are used only for identification or explanation and to the owners' benefit, without intent to infringe.

- Intel, LANDesk, and Pentium are registered trademarks of Intel Corporation.
- IBM and OS/2 are registered trademarks of International Business Machines.
- Symbios is a registered trademark of Symbios Logic Corporation.
- Windows and MS-DOS are registered trademarks of Microsoft Corporation.
- Sound Blaster AWE32 and SB16 are trademarks of Creative Technology Ltd.
- Adobe and Acrobat are registered trademarks of Adobe Systems Incorporated.

The product name and revision number are both printed on the board itself. Manual revisions are released for each board design represented by the digit before and after the period of the manual revision number. Manual updates are represented by the third digit in the manual revision number.

For previous or updated manuals, BIOS, drivers, or product release information, contact ASUS at <http://www.asus.com.tw> or through any of the means indicated on the following page.

SPECIFICATIONS AND INFORMATION CONTAINED IN THIS MANUAL ARE FURNISHED FOR INFORMATIONAL USE ONLY, AND ARE SUBJECT TO CHANGE AT ANY TIME WITHOUT NOTICE, AND SHOULD NOT BE CONSTRUED AS A COMMITMENT BY ASUS. ASUS ASSUMES NO RESPONSIBILITY OR LIABILITY FOR ANY ERRORS OR INACCURACIES THAT MAY APPEAR IN THIS MANUAL, INCLUDING THE PRODUCTS AND SOFTWARES DESCRIBED IN IT.

**Copyright © 1997 ASUSTeK COMPUTER INC. All Rights Reserved.**

Product Name:	<b>ASUS C-PKND</b>
Manual Revision:	<b>1.02</b>
Release Date:	<b>July 1997</b>

# ASUS CONTACT INFORMATION

---

## ASUSTeK COMPUTER INC.

### *Marketing Info*

Address: 150 Li-Te Road, Peitou, Taipei, Taiwan 112, ROC  
Telephone: +886-2-894-3447  
Fax: +886-2-894-3449  
Email: info@asus.com.tw

### *Technical Support*

Fax: +886-2-895-9254  
BBS: +886-2-896-4667  
Email: tsd@asus.com.tw  
WWW: www.asus.com.tw  
Gopher: gopher.asus.com.tw  
FTP: ftp.asus.com.tw/pub/ASUS

## ASUS COMPUTER INTERNATIONAL

### *Marketing Info*

Address: 721 Charcot Avenue, San Jose, CA 95131, USA  
Telephone: +1-408-474-0567  
Fax: +1-408-474-0568  
Email: info-usa@asus.com.tw

### *Technical Support*

BBS: +1-408-474-0569  
Email: tsd-usa@asus.com.tw  
WWW: www.asus.com

## ASUS COMPUTER GmbH

### *Marketing Info*

Address: Harkort Str. 25, 40880 Ratingen, BRD, Germany  
Telephone: 49-2102-445011  
Fax: 49-2102-442066  
Email: info-ger@asus.com.tw

### *Technical Support*

BBS: 49-2102-448690  
Email: tsd-ger@asus.com.tw  
Hotline: 49-2102-499712

# CONTENTS

---

<b>I. INTRODUCTION .....</b>	<b>7</b>
How this Manual is Organized .....	7
Item Checklist .....	7
<b>II. FEATURES .....</b>	<b>8</b>
Features of the ASUS C-PKND CPU Card .....	8
The ASUS C-PKND CPU Card .....	9
ASUS C-PKND CPU Card Layout .....	9
<b>III. INSTALLATION .....</b>	<b>10</b>
1. Jumpers .....	10
Jumper Settings .....	10
2. System Memory (DRAM/SDRAM & SRAM) .....	11
3. External Connectors .....	11
4. Central Processing Unit (CPU) .....	12
ASUS C-PKND Components .....	12
Preparing the CPU Card for Baseboard Installation .....	13
Optional AAVID Heatsink .....	15
Optional Elan Vital Heatsink .....	15
Installing the CPU Card into Your Computer .....	18
System Case .....	18
Opening the Computer .....	20
Power Connection Procedures .....	22
BIOS Support .....	22
Recommended Case Suppliers .....	23
ElanVital Corporation .....	23
Chenbro Micom Co., Ltd. ....	23
Chieftec Industrial Co., Ltd. ....	23
<b>IV. BIOS SOFTWARE .....</b>	<b>24</b>
Support Software .....	24
Flash Memory Writer Utility .....	24
Main Menu .....	24
Advanced Features Menu .....	25
Managing & Updating your Motherboard's BIOS .....	26

# CONTENTS

---

5. BIOS Setup .....	27
Load Defaults .....	28
Standard CMOS Setup .....	28
Details of Standard CMOS Setup .....	28
BIOS Features Setup .....	31
Details of BIOS Features Setup .....	31
Chipset Features Setup .....	34
Details of Chipset Features Setup .....	34
Power Management Setup .....	37
Details of Power Management Setup .....	37
PNP and PCI Setup .....	39
Details of PNP and PCI Setup .....	39
Load BIOS Defaults .....	41
Load Setup Defaults .....	41
Smart Alarm (LM78) Setup .....	42
Details of Smart Alarm (LM78) Setup .....	42
Supervisor Password and User Password .....	43
IDE HDD Auto Detection .....	44
Save & Exit Setup .....	45
Exit Without Saving .....	45
<b>V. DESKTOP MANAGEMENT .....</b>	<b>46</b>
Desktop Management Interface (DMI) .....	46
Introducing the ASUS DMI Configuration Utility .....	46
System Requirements .....	46
Using the ASUS DMI Configuration Utility .....	47
Edit DMI (or delete) .....	47
Save MIFD .....	48
Load MIFD .....	48
Load BIOS Defaults .....	48

# FCC & DOC COMPLIANCE

---

## ***Federal Communications Commission Statement***

This device complies with FCC Rules Part 15. Operation is subject to the following two conditions:

- This device may not cause harmful interference, and
- This device must accept any interference received, including interference that may cause undesired operation.

This equipment has been tested and found to comply with the limits for a Class B digital device, pursuant to Part 15 of the FCC Rules. These limits are designed to provide reasonable protection against harmful interference in a residential installation. This equipment generates, uses and can radiate radio frequency energy and, if not installed and used in accordance with manufacturer's instructions, may cause harmful interference to radio communications. However, there is no guarantee that interference will not occur in a particular installation. If this equipment does cause harmful interference to radio or television reception, which can be determined by turning the equipment off and on, the user is encouraged to try to correct the interference by one or more of the following measures:

- Re-orient or relocate the receiving antenna.
- Increase the separation between the equipment and receiver.
- Connect the equipment to an outlet on a circuit different from that to which the receiver is connected.
- Consult the dealer or an experienced radio/TV technician for help.

**WARNING!** The use of shielded cables for connection of the monitor to the graphics card is required to assure compliance with FCC regulations. Changes or modifications to this unit not expressly approved by the party responsible for compliance could void the user's authority to operate this equipment.

## ***Canadian Department of Communications Statement***

This digital apparatus does not exceed the Class B limits for radio noise emissions from digital apparatus set out in the Radio Interference Regulations of the Canadian Department of Communications.

# I. INTRODUCTION

---

## How this Manual is Organized

This manual is divided into the following sections:

- I. Introduction:** Manual information and checklist
- II. Features:** Information and specifications concerning this product
- III. Installation:** Instructions on setting up the CPU card
- IV. BIOS Setup:** BIOS software setup information
- V. DMI Utility:** BIOS supported Desktop Management Interface

## Item Checklist

Please check that your package is complete. If you discover damaged or missing items, please contact your retailer.

- ASUS C-PKND CPU card
- Two sets of Retention Mechanism and Heatsink Support
- Support software (view FILELIST.TXT detailed contents and description)
  - Bus Master IDE Drivers
  - Flash Memory Writer utility
  - Desktop Management Interface (DMI) Utility
  - Readme files for descriptions and use of the files
  - Technical Support Form
- CPU card support set
- ASUS C-P2T CPU termination card
- This user's manual

## II. FEATURES

---

### Features of the ASUS C-PKND CPU Card

The ASUS C-PKND is carefully designed for the demanding PC user who wants great versatility in the assembly of a computer system. The C-PKND:

- **PS/2 Connectors:** Has PS/2 mouse and PS/2 keyboard connectors on card.
- **Multi-Speed Support:** Supports dual Intel Pentium® II (233–266MHz) processors.
- **Intel Chipset:** Features Intel's 440FX PCIset with I/O subsystems.
- **Error Checking and Correcting (ECC):** Detects and corrects 1-bit memory errors using Intel's 440FX PCIset and parity DRAM modules.
- **CPU Built-In Level 2 Cache:** Supports either 512K or 256K Pipelined Burst Level 2 cache in the Pentium II Single Edge Contact (SEC) cartridge.
- **Easy Installation:** Supports autodetection of hard disks, PS/2 mouse, and Plug and Play devices to make setup virtually automatic through the BIOS.



# II. FEATURES

## The ASUS C-PKND CPU Card

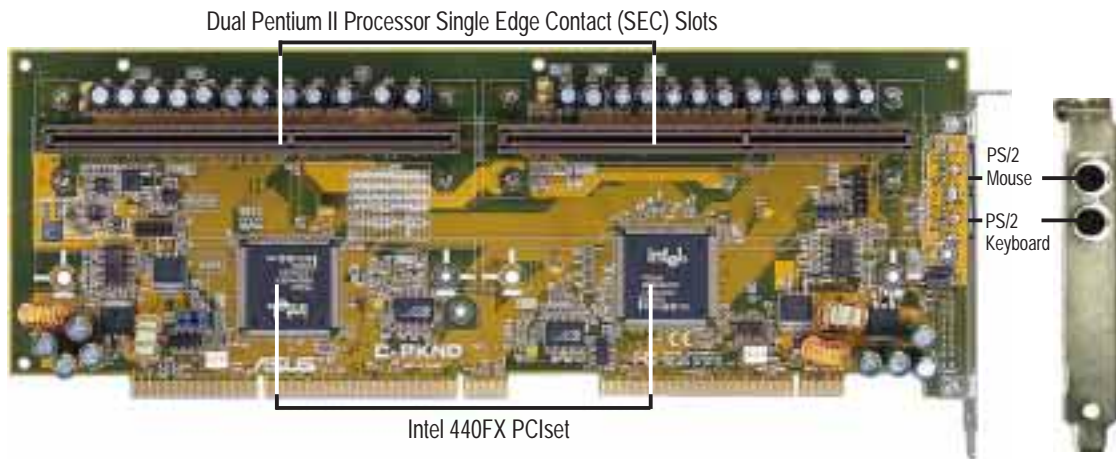

## ASUS C-PKND CPU Card Layout

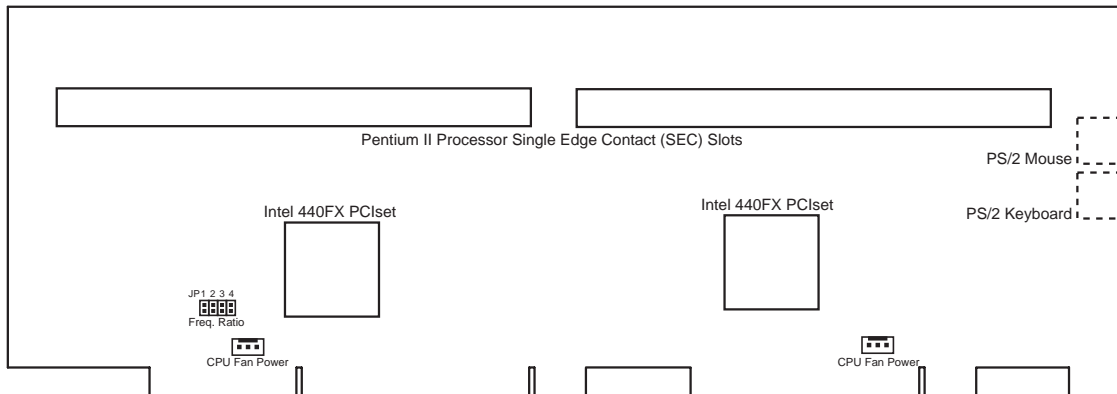

**II. FEATURES**  
**(C-PKND CPU Card II.**  
**FEATURES)**

# III. INSTALLATION

---

## Installation Steps

Before using your computer with the CPU card, complete the following steps:

1. Set jumpers on the CPU card and the baseboard.
2. Install memory in your computer.
3. Connect ribbon cables, cabinet wires, and power supply.
4. Install expansion cards.
5. Install the processor/s.
6. Set up the BIOS software.

## 1. Jumpers

Several hardware settings are made by using jumper caps to connect jumper pins (JP) on both the baseboard and CPU card. See the layout of the CPU card on page 9 and of the baseboard for locations of jumpers. For a description and explanation of the different jumper settings and their graphical representations as used in this manual, see your baseboard's manual.

**WARNING!** Computer boards and components contain very delicate integrated circuit (IC) chips. To protect them against damage from static electricity, take some precautions whenever you work on your computer.

1. Unplug your computer before working on the inside.
2. Use a grounded wrist strap when handling computer components. If you do not have one, touch both of your hands to a safely grounded object or to a metal object, such as the power supply case.
3. Hold components by the edges and try not to touch the IC chips, leads, or circuitry.
4. Place components on a grounded antistatic pad or on the bag that came with the component whenever the components are separated from the system.

### *Jumper Settings*

#### **1. CPU to BUS Frequency Ratio (JP1, JP2, JP3, JP4)**

These jumpers set the frequency ratio between the *Internal* frequency of the CPU and the *External* frequency (called the *BUS Clock*) within the CPU.

# III. INSTALLATION

Set the jumpers according to the internal speed of your processor, as follows:

CPU <u>Internal</u>	BUS <u>Ratio</u>	(CPU Card BUS Ratio)				Ext. <u>Freq.</u>	(CPU Ext. Freq. on Baseboard)	
		<u>JP1</u>	<u>JP2</u>	<u>JP3</u>	<u>JP4</u>		<u>JP3</u>	<u>JP2</u>
266MHz	4.0x	[short]	[short]	[open]	[short]	66MHz	[1-2]	[2-3]
233MHz	3.5x	[open]	[open]	[short]	[short]	66MHz	[1-2]	[2-3]

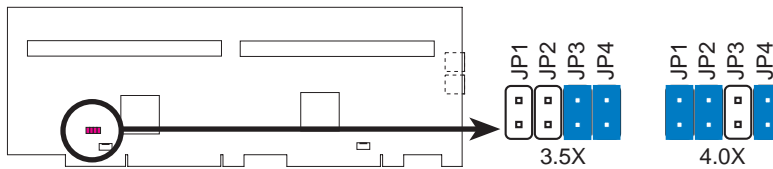

**CPU : BUS Frequency Ratio**

You must also set the CPU External Frequency on the baseboard, as follows:

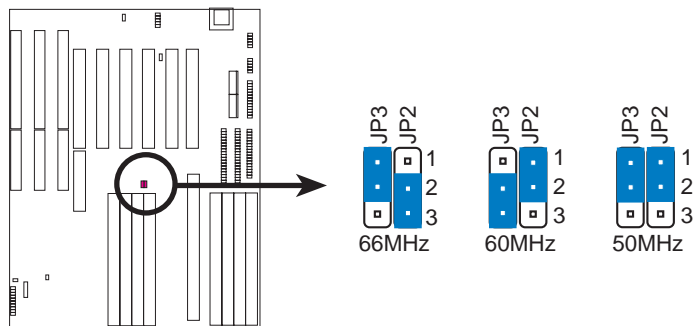

**CPU External Clock (BUS) Frequency Selection**

**III. INSTALLATION**  
(Jumpers)

**NOTE:** Voltage Regulator Output Selection (VID) is not needed for the Pentium II SEC slot because the Pentium II processor sends a VID signal directly to the CPU card's power controller.

**IMPORTANT:** Before proceeding to the next step, set the other jumpers on your baseboard. Refer to your baseboard's manual for the jumper settings.

## 2. System Memory (DRAM/SDRAM & SRAM)

Refer to your baseboard's documentation for procedures in installing memory modules.

## 3. External Connectors

Refer to your baseboard's documentation for instructions on connecting the ribbon cables, cabinet wires, and power supply.

# III. INSTALLATION

## 4. Central Processing Unit (CPU)

The C-PKND CPU card provides two Single Edge Contact (SEC) slots for Pentium II processors packaged in SEC cartridges.

This section provides information about the C-PKND CPU card and explains how to install the Pentium II processor into the CPU card, assemble the different components into the CPU card, and finally, install the CPU card into your computer.

### ASUS C-PKND Components

Check to see that your card came with the following components:

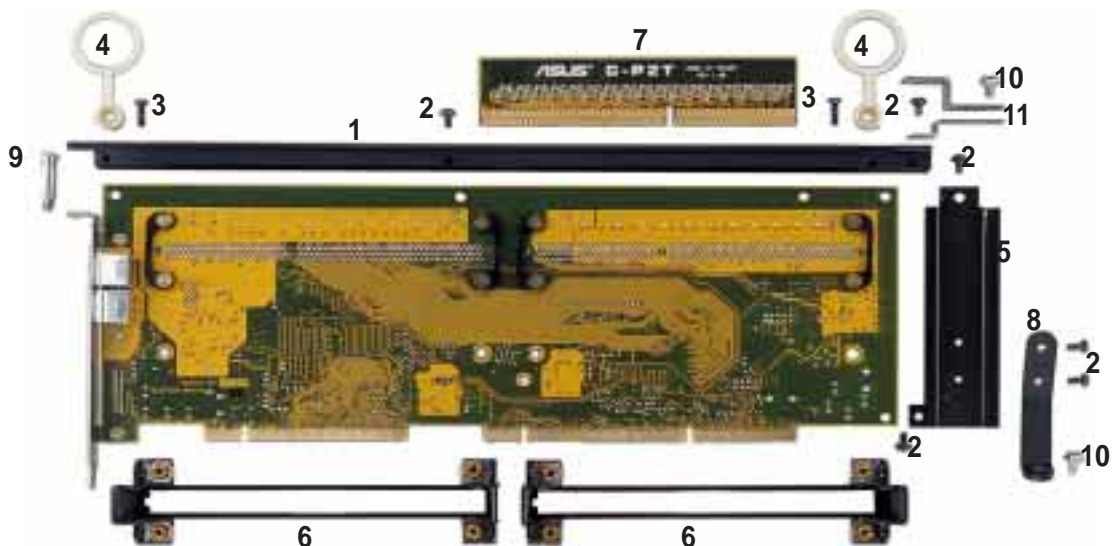

- |                               |  |
|-------------------------------|--|
| 1. Top support bar (1)        | 7. ASUS C-P2T CPU termination card (1) |
| 2. Pan head washer screws (6) | 8. Guide plate retainer (1)            |
| 3. Pan head screws (2)        | 9. Pan trim head washer screw (1)      |
| 4. Plastic rings (2)          | 10. Hex washer screws* (2)             |
| 5. Guide plate (1)            | 11. Support bar brackets† (2)          |
| 6. Retention mechanisms (2)   |  |

\*Common screws available with system case.

†Two are provided to accommodate differences in system case configurations. Only one is necessary when using Chenbro Micom's case or Chieftec Industrial's case. ElanVital Corp's cases do not require a bracket. See page 23 for details on these suppliers.

# III. INSTALLATION

## Preparing the CPU Card for Baseboard Installation

**WARNING!** Before handling any component, discharge static electricity from your body by using a grounded wrist strap or by touching the unpainted metal part of an object, such as a computer system case or power supply case. While working on the CPU card, ground yourself frequently to discharge any static electricity that may have accumulated in your body.

**NOTE:** The numbers in parentheses and in **boldface** in the following and succeeding steps pertains to the item number as indicated in the component list on page 12.

1. **Install the Top Support Bar:** Place the top support bar (1) over the top edge of the CPU card. Secure the bar in place, starting at the middle, with a pan head washer screw (2), and then on both sides, with pan head screws (3) and the plastic rings (4).

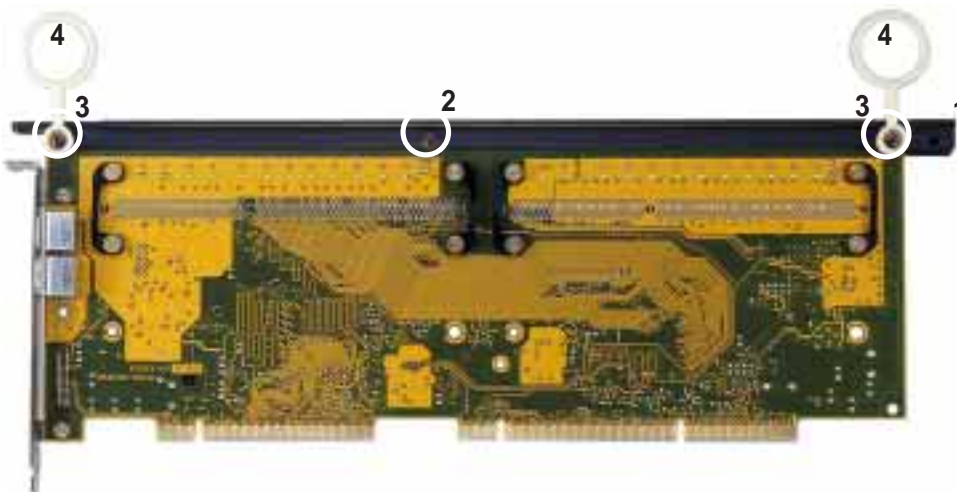

2. **Install the Guide Plate:** Secure the guide plate (5) in place on the edge of the CPU card with the pan head washer screws (2).





# III. INSTALLATION

- 3. Mount the Pentium II Retention Mechanism:** The retention mechanism (6) is designed to fit into the SEC slot only one way. Be sure to align the notch in the mechanism with the small rib on one side of the slot. Screw the captive nuts (encircled) in place.

**WARNING!** Do not overtighten the captive nuts. Doing so could damage your CPU card. Tighten captive nuts to no more than 6±1 inch/pound.

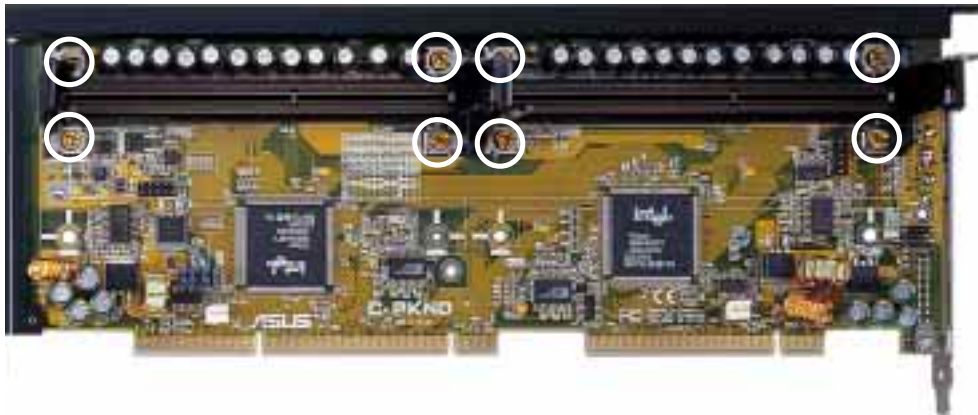

- 4. Mount the Heatsink:** Place the SEC cartridge face down on a flat surface and lay the heatsink flush on the back (metal side) of the SEC cartridge. Check the orientation of the heatsink against the pictures below. The thicker fin must be on the bottom. The top clamp is wider than the bottom clamp so only this orientation will fit. With a screw driver, push the clamps one at a time into the SEC cartridge. Be sure that the heatsink is firmly pressed against the the SEC cartridge. When correctly installed, no light must be showing through between the thermal pad of the heatsink and the SEC cartridge.

**WARNING!** If the heatsink is not mounted tightly against the SEC cartridge, the CPU will overheat. Be sure that sufficient air circulation is available across the SEC cartridge's passive heatsink. Without sufficient air circulation, the SEC cartridge could overheat and damage both the SEC cartridge and the baseboard. You may install an auxiliary fan, if necessary.

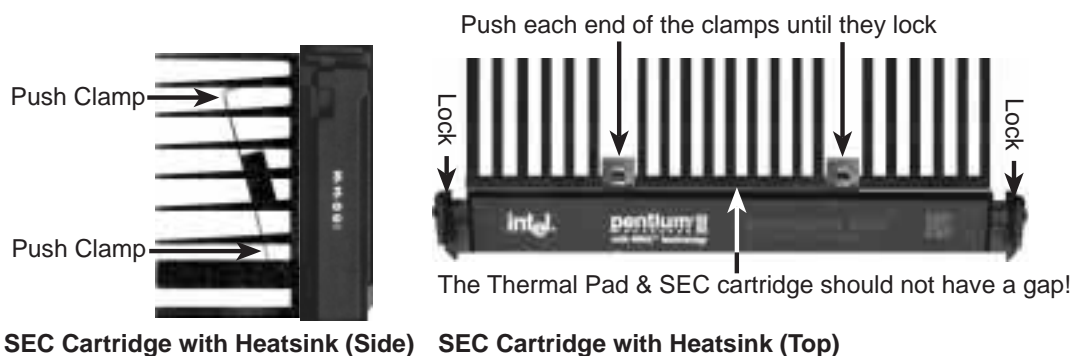

# III. INSTALLATION

---

The heatsinks shown in this manual are for reference purposes only. The recommend heatsinks for the Pentium II processor have a three-pin fan that can be connected to one of the CPU fan connectors on the CPU card or baseboard. These heatsinks have the added benefits of proper heat dissipation and, with baseboards that have the LM78 smart features and with the CPU fan leads connected into the baseboard's CPU fan connector, the ability to monitor the fan's RPM and use the alert function through the included LANDesk Client Manager (LDCM) software (available with the baseboard). This smart feature is not available when you connect the leads into the CPU card's fan connectors.

## *AAVID Heatsink*



The procedures for installing the AAVID heatsink with fan is similar as that for the heatsink without a fan. You will not, however, be able to use the heatsink support top bar because of the fan. The heatsink support top bar will, however, still be included in the package, in case you use a heatsink without a fan.

## *Elan Vital Heatsink*



The procedures for installing the Elan Vital heatsink with fan is also similar as that for the heatsink without a fan. The Elan Vital heatsink, however, comes with a lever to clamp the heatsink into the SEC cartridge. Mount the heatsink in the orientation as shown then flip the lever from "Unlock" to "Lock." You will not be able to also use the heatsink support top bar because of the fan. The heatsink support top bar will, however, still be included in the package, in case you use a heatsink without a fan.

# III. INSTALLATION

- 5. Insert the SEC Cartridge:** Push the SEC cartridge's two locks inward. With the heatsink facing the CPU card's connectors, press the cartridge gently but firmly until it is fully inserted.



**IMPORTANT:** If you are installing only one processor, you may install it in either the right or left SEC slot. You must terminate, however, the empty slot with the ASUS C-P2T CPU termination card (7) to maintain signal strength.



- 6. Secure the SEC Cartridge:** Secure the SEC cartridge in place by pushing the SEC cartridge locks outward so that the lock shows through the retention mechanism's lock holes.





# III. INSTALLATION

- 7. Secure the Heatsink:** Slide the Heatsink Support top bar into the bottom groove of the heatsink until it locks into the heatsink support base posts.

**NOTE:** This step is only applicable when you install the heatsink without fan.

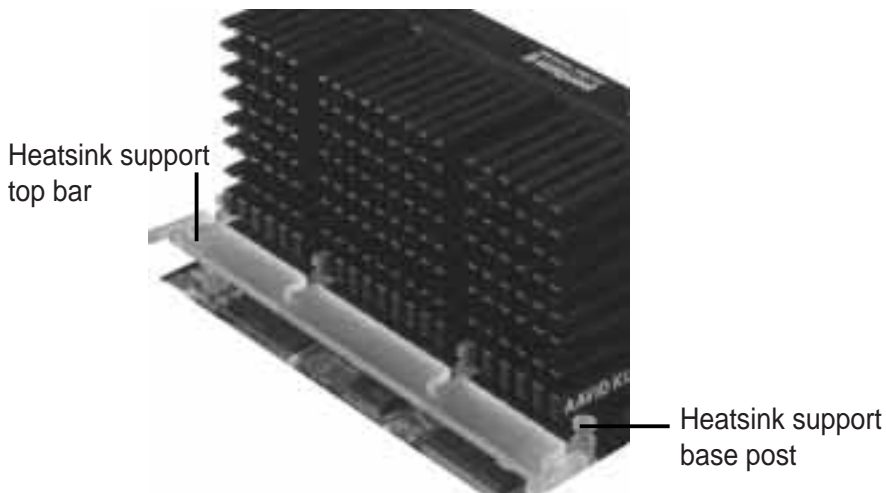

- 8. Install the Guide Plate Retainer:** Screw the retainer (8) into the guide plate.



- 9. Set Jumpers:** Refer to *CPU to BUS Frequency Ratio* and *BUS Frequency Selection* (baseboard's) for the jumper settings.

**NOTE:** If you are using a heatsink with fan and CPU fan connectors are not available on the baseboard, you may now connect the CPU fan leads into their corresponding connectors on the CPU card. If your baseboard has CPU fan connectors, connect the leads into the baseboard's connectors after the assembled CPU card is inserted into the baseboard. Connecting through the baseboard allows fan monitoring through the baseboard's LM78. LM78 is available only on baseboards with revision numbers of 2.04 and later.

# III. INSTALLATION

---

## Installing the CPU Card into Your Computer

The ASUS C-PKND CPU card requires installation onto ASUS baseboards, which are available separately from your retailer.

### *System Case*

The system case must be a full-sized server case to allow a clearance for the components installed on the CPU card. The CPU card also requires that the floppy disk and CD-ROM drives must not be placed over the baseboard. Be sure that the system cabinet has a minimum clearance area of 13.5 x 9.25 x 5" (34.3 x 23.5 x 12.7cm) for all the components to fit, as illustrated on the next page.



For a list of recommended case suppliers, see page 23.

# III. INSTALLATION

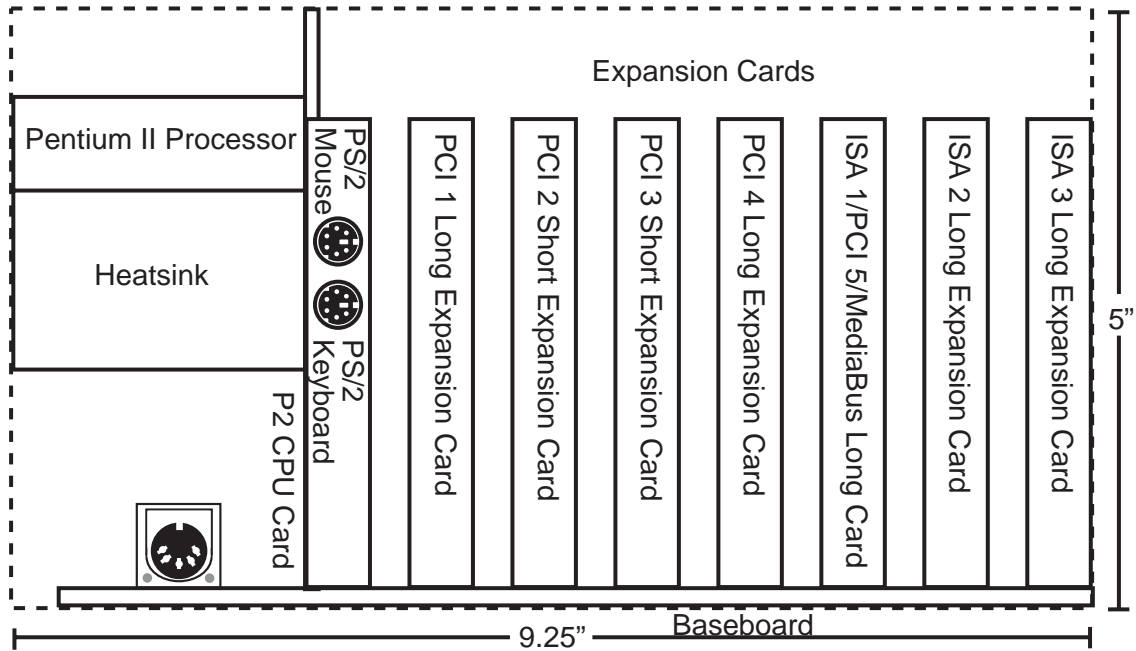

System Cabinet Clearance Area Requirement

III. INSTALLATION  
(CPU)



The C-PKND CPU card as assembled and installed on the baseboard.

# III. INSTALLATION

---

**IMPORTANT:** Before opening your computer, turn it off and unplug all the cables, including the power cord.

## *Opening the Computer*

1. Carefully lay the system case on its side.
2. Remove the system case cover.
3. Remove the screw from the first expansion port cover (for the CPU card).
4. Pull out the port access cover and set it aside.

**NOTE:** You will not need the port cover for the rest of these instructions, but save it in case you need to cover the port again.

**WARNING!** Before handling any components, discharge static electricity from your body by using a grounded wrist strap or by touching the unpainted metal part of the case or the power supply case. While working inside the computer, ground yourself frequently to discharge any static electricity that may have accumulated in your body.



5. Align the connector end of the CPU card with the CPU card slot. Ensure that the other end of the card fits into the proper card guide toward the front of the system case. Press the card gently but firmly until the connector is fully inserted. Do not rock the card side to side, instead press the card straight into the slot.

# III. INSTALLATION

- Secure the card by inserting and tightening the pan trim head washer screw (9) into the CPU card expansion port slot and the bottom retainer screw (10) into the system case. Install the support bar bracket (11) appropriate to your system case if needed. You may have to drill a hole to the system case to accommodate the bracket. If so, remove your CPU card first before drilling and be sure that the baseboard is protected from the drilling. Then, repeat steps 5 and 6.



- If you have other components, such as video, audio, and SCSI cards, to install, install them now. Refer to the respective components' documentation for installation procedures. Otherwise, proceed to the next step.
- Lift the system case so that it sits upright.



You are now finished with the installation. You may now proceed to the next step, "Power Connection Procedures."



# III. INSTALLATION

---

## Power Connection Procedures

1. When you are sure that all jumpers and connections are set up, replace the system case cover.
2. Make sure that all switches are off (in some systems, marked with ○).
3. Connect the power supply cord into the power supply located on the back of your system case according to your system user's manual.
4. Connect the power cord into a power outlet that is equipped with a surge protector.
5. You may then turn on your devices in the following order:
  - a. Monitor.
  - b. External SCSI devices (starting with the last device on the chain).
  - c. System power.
6. The power LED on the front panel of the system case will light. The monitor LED may light after the system's if it complies with "green" standards or if it has a power standby feature. The system will then run power-on tests. While the tests are running, additional messages will appear on the screen. If you do not see anything within 30 seconds from the time you turn on the power, the system may have failed a power-on test. Recheck your jumper settings and connections or call your retailer for assistance.
7. During power-on, hold down <Delete> to enter BIOS setup. Follow the instructions in section IV, BIOS SOFTWARE.

**Powering off your computer:** You must first exit or shut down your operating system before switching off the power switch. If you use Windows 95, click the **Start** button, click **Shut Down**, and then click **Shut down the computer?**. Do not turn off your computer until the "You can now safely turn off your computer" message appears.

## BIOS Support

Physically, the onboard 1MB Flash ROM chip can be used for any of the ASUS motherboards. However, the ROM must be programmed to contain BIOS for a specific motherboard and CPU. The wrong BIOS may cause problem booting-up your system. When you purchase a CPU card together with the baseboard, the onboard Flash ROM chip contains the BIOS for that CPU card. If you purchase a CPU card separately, a Flash ROM chip for the separate CPU card is supplied. You must remove the onboard ROM and switch it with the new ROM.

# III. INSTALLATION

---

## Recommended Case Suppliers

### *ElanVital Corporation*

Address: 4F, 13-5 Chung-Hua Road, Sanhsia, Taipei, Taiwan 237, ROC

Telephone: +886-2-674-2141

Fax: +886-2-674-2143

Email: velan@ms2.hinet.net

- Desktop: Part Number: T10-DK
- Server: Part Number: S50

### *Chenbro Micom Co., Ltd.*

Address: 5F, 11 Chung Shan Road, Lane 327, Alley 11,  
Chung Ho City, Taipei Hsien, Taiwan, ROC

Telephone: +886-2-248-9505

Fax: +886-2-242-7304

Email: serverdept@chenbro.com.tw

WWW: www.chenbro.com.tw

- Server: Part Number: 9611

### *Chieftec Industrial Co., Ltd.*

Address: 6F, 242 Chang De Road, Sec. 4, Taipei, Taiwan, ROC

Telephone: +886-2-883-2491

Fax: +886-2-883-2493

- Server: Part Number: AA-02W

# IV. BIOS SOFTWARE

---

## Support Software

**FILELIST.TXT** – View this file to see the files included in the support software.

**PFLASH.EXE** – This is the Flash Memory Writer utility that updates the BIOS by uploading a new BIOS file to the programmable flash ROM chip on the baseboard. To determine the BIOS version, check the last four numbers of the code displayed on the upper left corner of your screen during the test routines when you turn on your machine.

**xxxxkm.xxx** – BIOS file for the C-PKND on the baseboard with LM78 (available on Rev. 2.04 or later baseboards)

**xxxxk.xxx** – BIOS file for the C-PKND on the baseboard without LM78 (Rev. 1.41 or earlier baseboards)

## Flash Memory Writer Utility

The flash memory writer utility must be run while the system is in **real mode**. In particular, the “Update BIOS Main Block From File” and “Update BIOS Including Boot Block and ESCD” options require real mode. To run this utility, boot from a system floppy disk without the AUTOEXEC.BAT and CONFIG.SYS files.

```
ASUSTeK PNP BIOS
FLASH MEMORY WRITER V1.5
Copyright (C) 1995, ASUSTeK COMPUTER Inc.

Flash Type -- SST 29EE010
Current BIOS Revision: #401A0-xxxx
Choose one of the following:
 1. Save Current BIOS To File
 2. Update BIOS Main Block From File
 3. Advanced Features

Enter Choice: [ 1]

Press ESC To Exit
```

xxxx denotes the current BIOS version stored in the Flash EPROM

**IMPORTANT:** If “unknown” is displayed after **Flash Type --** , the memory chip is not programmable or is not supported with the PnP BIOS and therefore cannot be programmed by the Flash Memory Writer utility.



# IV. BIOS SOFTWARE

---

## Main Menu

### 1. Save Current BIOS To File

This option allows you to copy the contents of the flash memory onto a floppy disk. This gives you a backup copy of the original motherboard BIOS in case you need to reinstall it. Create a bootable DOS diskette without AUTOEXEC.BAT and CONFIG.SYS and save both PFLASH.EXE and the BIOS file(s) to it. **Note:** BIOS FEATURES SETUP Boot Sequence needs to be set to A first in order to boot from your disk drive A.

### 2. Update BIOS Main Block From File

This option updates the BIOS from a file on the disk. The file can be either a new file or a backup file created by the “Save Current BIOS To File” option. If the boot block in the file is different from the current boot block, this option will not update the main block. Instead, it will display the following messages.

```
Boot Block of New BIOS is different from old one !!!
Please Use 'Advanced Features' to flash whole BIOS !!!
```

### 3. Advanced Features

This option displays the Advanced Features screen for clearing the PnP configuration record and updating the motherboard BIOS.

## Advanced Features Menu

```
Advanced Features

Flash Type -- SST 29EE010
Current BIOS Revision: #401A0-xxxx
Choose one of the following:
1. Clear PNP ESCD Parameter Block
2. Update BIOS Including Boot Block and ESCD

Enter Choice: [ 2]

Press ESC To Exit
```

xxxx denotes the current BIOS version stored in the Flash EPROM

#### 1. Clear PNP ESCD Parameter Block

This option erases the Plug-and-Play (PnP) configuration record.

#### 2. Update BIOS Including Boot Block and ESCD

This option updates the boot block, the baseboard BIOS, and the PnP extended system configuration data (ESCD) parameter block from a new BIOS file.

# IV. BIOS SOFTWARE

---

## Managing & Updating your Motherboard's BIOS

### About the BIOS files:

When purchasing a CPU card and baseboard together, the BIOS is pre-programmed as well as supplied on the support disk for your configuration. A C-PKND BIOS image file will be provided on the support disk for both the baseboard with and without the LM78 Hardware Monitor chip. If you are purchasing the C-PKND separately, and your baseboard has an LM78 chip on it (PCB Rev. 2.04 or later), then use the xxxxkm.xxx BIOS file. If your baseboard does not have an LM78 chip on it (PCB Rev. 1.41 or earlier), then use the xxxk.xxx BIOS file.

### Updating BIOS (only when necessary):

1. Download an updated BIOS file from the Internet (WWW or FTP) or BBS, and save it to the disk you created earlier. See ASUS Contact Information on page 3 for details.
2. Turn off your computer, open the system cabinet, and set the **Flash ROM Boot Block Programming** jumper of the baseboard to *Program* or *Enabled*.
3. Boot from the floppy disk you created earlier.
4. At the DOS prompt, type PFLASH <Enter>
5. Select option "2. Update BIOS Main Block From File" from the Main Menu (or option "2. Update BIOS Including Boot Block and ESCD" from the Advanced Features menu if prompted by option 2 of the Main Menu).
6. On the next screen displayed, type the complete filename and extension of the new BIOS file, and press <Enter>. The utility then updates the BIOS file from disk.

**WARNING!** If you encounter problems while updating the new BIOS, **do not** turn off the system because doing so may prevent your system from restarting. Instead, repeat the process. If the problem persists, use the original BIOS file you saved to the disk earlier. If the utility is unable to successfully update a complete BIOS file, your system may not boot up. If this happens, your system will need service.

7. After successfully updating the new BIOS file, exit the utility. Turn off the system, then set the **Flash ROM Boot Block Programming** jumper of the baseboard back to its default setting of *Protect* or *Disabled*.
8. Turn on your computer and hold down <Delete> to run the CMOS Setup Utility. Select "Load Setup Defaults" to load the new BIOS, after which you may set other items from the main menu.

# IV. BIOS SOFTWARE

## 5. BIOS Setup

The baseboard supports two kinds of programmable Flash ROM chips: 5-volt and 12-volt. Either memory chip can be updated when BIOS upgrades are released. Use the Flash Memory Writer utility to download the new BIOS file into the flash chip as described in detail in this section.

All computer motherboards or baseboards provide a Setup utility program for specifying the system configuration and settings. If your baseboard came in a computer system, the proper configuration entries may have already been made. If so, run the Setup utility (as described later) and note the configuration settings, particularly, the hard disk specifications, for future reference.

When you install the baseboard, reconfigure your system or receive a Run Setup message, you will need to enter new setup information. This section describes how to configure your system using this utility.

The BIOS ROM of the system stores the Setup utility. When you turn on the computer, the system provides you with an opportunity to start Setup. During the Power-On Self Test (POST), press <Delete> to run the Setup utility. If you press <Delete> too late, the test routines will continue. In this case, reset the system (by pressing <Ctrl> + <Alt> + <Delete> or by pressing the Reset button) and try again. You can also restart your system by turning off your computer and then back on again. Do this only if the first two methods fail.

When you run Setup, the CMOS Setup Utility main screen displays with the following options:



**NOTE:** The SMART ALARM (LM78) SETUP is only available on baseboards with the optional onboard LM78 chip.

# IV. BIOS SOFTWARE

## Load Defaults

The “Load BIOS Defaults” option loads the minimum settings for troubleshooting. “Load Setup Defaults”, on the other hand, is for loading optimized defaults for regular use. Choosing defaults at this level, will modify all applicable settings.

A section at the bottom of the preceding screen displays the control keys for this screen. Take note of these keys and their respective uses.

## Standard CMOS Setup

This “Standard CMOS Setup” option allows you to record some basic system hardware configuration and set the system clock and error handling. If the motherboard is already installed in a working system, you will not need to select this option anymore. However, if the configuration stored in the CMOS memory on the board gets lost or damaged, or if you change your system hardware configuration, you will need to respecify the configuration values. The configuration values usually get lost or corrupted when the power of the onboard CMOS battery weakens.



IV. BIOS  
(Standard CMOS)

The preceding screen provides you with a list of options. At the bottom of this screen are the control keys for this screen. Take note of these keys and their respective uses.

User-configurable fields appear in a different color. If you need information on the selected field, press <F1>. The help menu will then appear to provide you with the information you need. The memory display at the lower right side of the screen is read-only and adjusts according to the installed memory in your system.

## Details of Standard CMOS Setup

### Date

To set the date, highlight the “Date” field and then press either <Page Up>/<Page Down> or <+>/<-> to set the current date. Follow the month, day and year format. Valid values for month, day and year are: **Month: (1 to 12), Day: (1 to 31), Year: (up to 2079).**

# IV. BIOS SOFTWARE

---

## Time

To set the time, highlight the “Time” field and then press either <Page Up>/<Page Down> or <+>/<-> to set the current time. Follow the hour, minute and second format. Valid values for hour, minute and second are: (**Hour: (00 to 23)**, **Minute: (00 to 59)**, **Second: (00 to 59)**). Press <Enter> twice if you do not want to modify the current time.

**NOTE:** You can bypass the date and time prompts by creating an AUTOEXEC.BAT file. For information on how to create this file, please refer to the MS-DOS manual.

## Hard Disks

This field records the specifications for all non-SCSI hard disk drives installed in your system. The onboard PCI IDE connectors provide Primary and Secondary channels for connecting up to four IDE hard disks or other IDE devices. Each channel can support up to two hard disks; the first of which is the “master” and the second is the “slave”.

Specifications for SCSI hard disks do not need to be entered because they operate using device drivers and are not supported by any BIOS. If you install either the optional PCI-SC200 or PCI-SC860 SCSI controller card into the motherboard, see section VI for instructions. If you install other vendor’s SCSI controller card, refer to their respective documentations on how to install the required SCSI drivers.

### For IDE hard disk drive setup, you can:

- Use the *Auto* setting for detection during bootup.
- Use the IDE HDD AUTO DETECTION in the main menu to automatically enter the drive specifications.
- Enter the specifications manually by using the “User” option.

The entries for specifying the hard disk type include **CYLS** (number of cylinders), **HEAD** (number of read/write heads), **PRECOMP** (write precompensation), **LANDZ** (landing zone), **SECTOR** (number of sectors) and **MODE**. The **SIZE** field automatically adjusts according to the configuration you specify. The documentation that comes with your hard disk should provide you with the information regarding the drive specifications.

The **MODE** entry is for IDE hard disks only, and can be ignored for MFM and ESDI drives. This entry provides three options: *Normal*, *Large*, *LBA*, or *Auto* (see below). Set **MODE** to *Normal* for IDE hard disk drives smaller than 528MB; set it to *LBA* for drives over 528MB that support Logical Block Addressing (LBA) to allow larger IDE hard disks; set it to *Large* for drives over 528MB that do not support LBA. *Large* type of drive can only be used with MS-DOS and is very uncommon. Most IDE drives over 528MB support the *LBA* mode.



# IV. BIOS SOFTWARE

---

## **Autodetection of hard disks on bootup**

For each field: Primary Master, Primary Slave, Secondary Master, and Secondary Slave, you can select *Auto* under the TYPE and MODE fields. This will enable auto detection of your IDE hard disk during bootup. This will allow you to change your hard disks (with the power off) and then power on without having to reconfigure your hard disk type. If you use older hard disks that do not support this feature, then you must configure the hard disk in the standard method as described earlier by the “User” option.

**NOTE:** After the IDE hard disk drive information has been entered into BIOS, new IDE hard disk drives must be partitioned (such as with FDISK) and then formatted before data can be read from and write on. Primary IDE hard disk drives must have its partition set to *active* (also possible with FDISK).

**NOTE:** SETUP Defaults are noted in parenthesis next to each function heading.

## **Drive A / Drive B (None)**

These fields record the types of floppy disk drives installed in your system. The available options for drives A and B are: *360KB, 5.25 in.; 1.2MB, 5.25 in.; 720KB, 3.5 in.; 1.44MB, 3.5 in.; 2.88MB, 3.5 in.; None*

To enter the configuration value for a particular drive, highlight its corresponding field and then select the drive type using the left- or right-arrow keys.

## **Floppy 3 Mode Support (Disabled)**

This is the Japanese standard floppy drive. The standard stores 1.2MB in a 3.5inch diskette. This is normally disabled but you may choose from either: *Drive A, Drive B, Both, and Disabled*

## **Video (EGA/VGA)**

Set this field to the type of video display card installed in your system. The options are *EGA/VGA, CGA 49, CGA 80, and Mono* (for Hercules or MDA).

If you are using a VGA or any higher resolution card, choose *EGA/VGA*.

## **Halt On (All Errors)**

This field determines which types of errors will cause the system to halt. Choose from *All Errors; No Errors; All,But Keyboard; All,But Diskette; and All,But Disk/Key*.

# IV. BIOS SOFTWARE

## BIOS Features Setup

This “BIOS Features Setup” option consists of configuration entries that allow you to improve your system performance, or let you set up some system features according to your preference. Some entries are required by the motherboard’s design to remain in their default settings.



A section at the lower right of the screen displays the control keys you can use. Take note of these keys and their respective uses. If you need information on a particular entry, highlight it and then press <F1>. A pop-up help menu will appear to provide you with the information you need. <F5> loads the last set values, <F6> and <F7> loads the BIOS default values and Setup default values, respectively.

**NOTE:** SETUP Defaults are noted in parenthesis next to each function heading.

### Details of BIOS Features Setup

#### Virus Warning (Disabled)

This field protects the boot sector and partition table of your hard disk against accidental modifications. Any attempt to write to them will cause the system to halt and display a warning message. If this occurs, you can either allow the operation to continue or use a bootable virus-free floppy disk to reboot and investigate your system. This setting is recommended because conflicts with new operating systems. Installation of new operating systems require that you disable this to prevent write errors.

#### CPU Level 1 Cache / CPU Level 2 Cache (Enabled)

These fields allow you to choose from the default of *Enabled* or choose *Disabled* to turn on or off the CPU’s Level 1 and Level 2 built-in cache.

#### BIOS Update (Enabled)

This functions as an update loader integrated into the BIOS to supply the processor with the required data. The BIOS will load the update on all processors during system bootup in the default position of *Enabled*.

# IV. BIOS SOFTWARE

---

## **CPU Fast String (Enabled)**

Leave on default setting of *Enabled* for best performance.

## **Deturbo Mode (Disabled)**

When *Enabled*, FLUSH# signal is held asserted to disable caching and the P6 bus pipeline will be stalled. This allows software to run at a reduced-speed. The default is set to *Disabled* to allow maximum processing speed.

## **Quick Power On Self Test (Enabled)**

This field speeds up the Power-On Self Test (POST) routine by skipping retesting a second, third, and fourth time. Setup default setting for this field is *Enabled*. A complete test of the system is done on each test.

## **HDD Sequence SCSI/IDE First (IDE)**

When using both SCSI and IDE hard disk drives, IDE is always the boot disk using drive letter C (default setting of *IDE*). This new feature allows a SCSI hard disk drive to be the boot disk when set to *SCSI*. This allows multiple operating systems to be used on both IDE and SCSI drives or the primary operating system to boot using a SCSI hard disk drive.

## **Boot Sequence (C,A)**

This field determines where the system looks first for an operating system. Options are *C,A*; *A,CDROM,C*; *CDROM,C,A*; *D,A*; *E,A*; *F,A*; *C only*; and *A,C*. The setup default setting is to check first the hard disk and then the floppy drive, that is, *C, A*.

## **Boot Up Floppy Seek (Disabled)**

When enabled, the BIOS will seek drive A once.

## **Floppy Disk Access Control (R/W)**

This allows protection of files from the computer system to be copied to floppy disks by allowing the setting of *Read Only* to only allow reads from the floppy disk drive but not writes. The setup default *R/W* allows both reads and writes.

## **IDE HDD Block Mode Sectors (HDD MAX)**

This field enhances hard disk performance by making multi-sector transfers instead of one sector per transfer. Most IDE drives, except older versions, can utilize this feature. Selections are *HDD MAX* (default), *Disabled*, *2*, *4*, *8*, *16*, and *32*.

## **Security Option (System)**

When you specify a *Supervisor Password* and/or *User Password* (explained later in this section), the Security Option field determines when the system prompts for the password. The default setting is *System*, where the system prompts for the User Password every time you start your system. The other option is *Setup*, where the system goes through its startup routine unless the Setup utility is called, when the system prompts for the Supervisor Password.



# IV. BIOS SOFTWARE

---

## **PS/2 Mouse Function Control (Auto)**

The default of *Auto* allows the system to detect a PS/2 Mouse on bootup. If detected, IRQ12 will be used for the PS/2 Mouse. IRQ12 will be reserved for expansion cards if a PS/2 Mouse is not detected. *Disabled* will reserve IRQ12 for expansion cards and therefore the PS/2 Mouse will not function.

## **PCI/VGA Palette Snoop (Disabled)**

Some display cards that are nonstandard VGA such as graphics accelerators or MPEG Video Cards may not show colors properly. The setting *Enabled* should correct this problem. Otherwise leave this on the setup default setting of *Disabled*.

## **OS/2 Onboard Memory > 64M (Disabled)**

When using OS/2 operating systems with installed DRAM of greater than 64MB, you need to set this option to *Enabled* otherwise leave this on the setup default of *Disabled*.

.....

## **Video ROM BIOS Shadow (Enabled)**

This field allows you to change the video BIOS location from ROM to RAM. Relocating to RAM enhances system performance because information access is faster than the ROM.

## **C8000 – CBFFF Shadow to DC000 – DFFFF Shadow (Disabled)**

These fields are used for shadowing other expansion card ROMs. If you install other expansion cards with ROMs on them, you will need to know which addresses the ROMs use to shadow them specifically. Shadowing a ROM reduces the memory available between 640K and 1024K by the amount used for this purpose.

## **Boot Up NumLock Status (On)**

This field enables users to activate the Number Lock function upon system boot.

## **Boot Up System Speed (High)**

This has no function and should be left on the setup default.

## **Typematic Rate Setting (Disabled)**

When enabled, you can set the two typematic controls listed next. Setup default setting is *Disabled*.

## **Typematic Rate (Chars/Sec) (6)**

This field controls the speed at which the system registers repeated keystrokes. Options range from 6 to 30 characters per second. Setup default setting is 6; other settings are 8, 10, 12, 15, 20, 24, and 30.

## **Typematic Delay (Msec) (250)**

This field sets the time interval in milliseconds for displaying the first and second characters. Four delay rate options are available: 250 (default), 500, 750, and 1000.

# IV. BIOS SOFTWARE

## Chipset Features Setup

This “Chipset Features Setup” option controls the configuration of the board’s chipset. Control keys for this screen are the same as for the previous screen.



**NOTE:** SETUP Defaults are noted in parenthesis next to each function heading.

### Details of Chipset Features Setup

#### Auto Configuration (60ns DRAM)

The default setting of *60ns DRAM* sets the optimal timings for items 2 [**DRAM Read Burst (B/E/F)**] through 6 (**MA Wait State**) for 60ns DRAM modules. If you are using 70ns DRAM modules, you must change this item to *70ns DRAM*. See section III for DRAM installation information.

#### DRAM Refresh Type (RAS Only)

Leave on default setting of *RAS Only* because this is the current standard.

#### CPU-to-PCI IDE Posting (Enabled)

Leave on default setting of *Enabled* so that the CPU to PCI IDE posting cycles are treated as normal I/O write transactions.

#### USWC Write Posting (Enabled)

Leave on default setting of *Enabled* to allow USWC write posting during I/O bridge access.

#### CPU-to-PCI Write Post (Enabled)

The default setting of *Enabled* will increase the efficiency of the PCI bus and speed up the execution in the processor.

#### PCI-to-DRAM Pipeline (Enabled)

The default of *Enabled* will increase the bandwidth of the path between the PCI and the DRAM to enhance the PCI bus efficiency and DRAM accessing.

#### PCI Burst Write Combining (Enabled)

The default setting of *Enabled* will increase the efficiency of PCI bus by combining several CPU to PCI write cycles into one. VGA performance is increased by this action.

# IV. BIOS SOFTWARE

## Read-Around-Write (Enabled)

The default setting of *Enabled* will increase the execution efficiency of the processor. It allows the processor to execute read commands out of order if there is no dependence between these read and other write commands.

## 16-bit I/O Recovery Time (1 BUSCLK)

Timing for 16-bit ISA cards (leave on default setting of *1 BUSCLK*)

## 8-bit I/O Recovery Time (1 BUSCLK)

Timing for 8-bit ISA cards (leave on default setting of *1 BUSCLK*)

## Video Memory Cache Mode (UC)

*USWC* (uncacheable, speculative write combining) is a new cache technology for the video memory of the processor. It can greatly improve the display speed by caching the display data. You must leave this on the default setting of *UC* (uncacheable) if your display card cannot support this feature; otherwise, your system may not boot.

## Memory Hole At 15M-16M (Disabled)

Enabling this feature reserves 15MB to 16MB memory address space to ISA expansion cards that specifically require this setting. This makes the memory from 15MB and up unavailable to the system. Expansion cards can only access memory up to 16MB. The default is *Disabled*.

## [DRAM and ECC]

If all your DRAM modules have parity chips (e.g. 8 chips + 4 parity chips), they are considered 36bits. This motherboard sums the memory per bank and therefore two modules will give 72bits and the following will be displayed:

```
DRAM are 72 bits wide      F5 : Old Values (Shift)F2 : Color
Data Integrity (PAR/ECC) : Disabled  F6 : Load BIOS Defaults
DRAM ECC/PARITY Select   : Parity    F7 : Load Setup Defaults
```

If your DRAM modules do not have parity chips (e.g. 8 chips), they are considered 32bits and the following will be displayed instead:

```
DRAM are 64 (Not 72) bits wide  F5 : Old Values (Shift)F2 : Color
Data Integrity (PARITY) : Disabled  F6 : Load BIOS Defaults
                          F7 : Load Setup Defaults
```

The default of *Disabled* for **Data Integrity (PARITY)** will not show memory errors on your monitor. When using parity DRAM modules, you can select *ECC* (Error Checking and Correcting) to correct 1 bit memory errors that may occur in the memory, otherwise *Parity* is the default. (See section III for more information on DRAM memory modules.)

.....

## Onboard FDC Controller (Enabled)

When enabled, this field allows you to connect your floppy disk drives to the onboard floppy disk drive connector instead of a separate controller card. If you want to use a different controller card to connect the floppy disk drives, set this field to *Disabled*.

## IV. BIOS SOFTWARE

---

### **Onboard FDC Swap A & B (No Swap)**

This field allows you to reverse the hardware drive letter assignments of your floppy disk drives. Two options are available: *No Swap* and *Swap AB*. If you want to switch drive letter assignments through the onboard chipset, set this field to *Swap AB*.

### **Onboard Serial Port 1 (3F8H/IRQ4)**

Settings are *3F8H/IRQ4* (default), *2F8H/IRQ3*, *3E8H/IRQ4*, *2E8H/IRQ10*, and *Disabled* for the onboard serial connector.

### **Onboard Serial Port 2 (2F8H/IRQ3)**

Settings are *3F8H/IRQ4*, *2F8H/IRQ3* (default), *3E8H/IRQ4*, *2E8H/IRQ10*, and *Disabled* for the onboard serial connector.

### **Onboard Parallel Port (378H/IRQ7)**

This field sets the address of the onboard parallel port connector. You can select either *3BCH / IRQ 7*, *378H / IRQ 7*, *278H / IRQ 5*, or *Disabled*. If you install an I/O card with a parallel port, ensure that there is no conflict in the address assignments. The PC can support up to three parallel ports as long as there are no conflicts for each port.

### **Parallel Port Mode (ECP+EPP)**

This field allows you to set the operation mode of the parallel port. The setting *Normal*, allows normal-speed operation but in one direction only; *EPP* allows bidirectional parallel port operation at maximum speed; *ECP* allows the parallel port to operate in bidirectional mode and at a speed faster than the maximum data transfer rate; *ECP+EPP* (default) allows normal speed operation in a two-way mode.

### **ECP DMA Select (3)**

This selection is available only if you select either *ECP* or *ECP+EPP* as the **Parallel Port Mode**. Select either DMA Channel *1*, *3* (default), or *Disable*.

### **UART2 Use Infrared (Disabled)**

When enabled, this field activates the onboard infrared feature and sets the second serial UART to support the infrared module connector on the baseboard. If your system already has a second serial port connected to the onboard COM2 connector, it will no longer work if you enable the infrared feature. By default, this field is set to *Disabled*, which leaves the second serial port UART to support the COM2 serial port connector. See section III of the baseboard manual for the **IrDA-compliant infrared module connector**.

### **Onboard PCI IDE Enable (Both)**

You can select to enable the *Primary* IDE channel, *Secondary* IDE channel, *Both* (default), or *Disable* both channels (for systems with only SCSI drives).

### **IDE 0 Master/Slave Mode / IDE 1 Master/Slave Mode (Auto)**

Each channel (0 and 1) has both a master and a slave making four IDE devices possible. Because each IDE device may have a different Mode timing (0, 1, 2, 3, 4), it is necessary for these to be independent. The default setting of *Auto* will allow autodetection to ensure optimal performance.



# IV. BIOS SOFTWARE

## Power Management Setup

This “Power Management Setup” option allows you to reduce power consumption. This feature turns off the video display and shuts down the hard disk after a period of inactivity.



**NOTE:** SETUP Defaults are noted in parenthesis next to each function heading.

### Details of Power Management Setup

#### Power Management (User Define)

This field acts as the master control for the power management modes. *Max Saving* puts the system into power saving mode after a brief period of system inactivity; *Min Saving* is almost the same as *Max Saving* except that this time the system inactivity is longer; *Disable* disables the power saving features; *User Define*, the default setting, allows you to set power saving options according to your preference.

**IMPORTANT:** Advanced Power Management (APM) should be installed to keep the system time updated when the computer enters suspend mode activated by the BIOS Power Management. For DOS environments, you need to add `DEVICE=C:\DOS\POWER.EXE` in you `CONFIG.SYS`. For Windows 3.x and Windows 95, you need to install Windows with the APM feature. A battery and power cord icon labeled “Power” will appear in the “Control Panel.” Choose “Advanced” in the Power Management Field.

#### Video Off Option (Susp,Stby -> Off )

This field determines when to activate the video off feature for monitor power management. The settings are *All Modes -> Off*; *Always On*; *Suspend -> Off*; and *Susp,Stby -> Off*.

# IV. BIOS SOFTWARE

---

## **Video Off Method (V/H SYNC+Blank)**

This field defines the video off features. The following options are available: *V/H SYNC+Blank*, *DPMS Standby*, *DPMS Suspend*, *DPMS OFF*, *DPMS Reduce ON*, and *Blank Screen*. The default setting, *V/H SYNC+Blank*, blanks the screen and turns off vertical and horizontal scanning. The DPMS (Display Power Management System) features allow the BIOS to control the video display card if it supports the DPMS feature. *Blank Screen* only blanks the screen (use this for monitors without power management or “green” features. If set up in your system, your screen saver will not display with *Blank Screen* selected).

## **Suspend Switch (Enable)**

This field allows you to *Enable* or *Disable* the SMI connector on the baseboard. This connector connects to the lead from the Suspend switch mounted on the system case.

## **Doze Speed (div by) (8) / Stdby Speed (div by) (32)**

These two fields set the CPU speed during each mode. The number indicates what the normal CPU speed is divided by.

## **PM Timers (Disable)**

This section controls the time-out settings for the Power Management scheme. The fields included in this section are **HDD Power Down**, which places the hard disk into its lowest power consumption mode, and the **Doze Mode**, **Standby Mode** and **Suspend Mode**.

The system automatically “wakes up” from any power saving mode when there is system activity, such as when a key is pressed, or when there is activity detected from the enabled IRQ channels.

**HDD Power Down** shuts down any IDE hard disk drives in the system after a period of inactivity. This time period is user-configurable at *1–15 Min* or *Disable*. This feature does not affect SCSI hard drives.

**Doze Mode**, **Standby Mode**, and **Suspend Mode** set the period of time after which each of these modes activate: *1 Min*, *2 Min*, *4 Min*, *8 Min*, *10 Min*, *20 Min*, *30 Min*, *1 Hour*, *2 Hour*, and *4 Hour*.

## **PM Events**

This section sets the wake-up call of the system. If activity is detected from any enabled IRQ channels in the left group, the system wakes up from suspended mode. You can enable power management for IRQ3–IRQ15 individually in the list at the right side of the screen. The power management feature will work on the enabled IRQ channels.

**NOTE:** A Microsoft serial or compatible mouse will use either COM1 (IRQ4) or COM2 (IRQ3), and a PS/2 mouse will use IRQ12. If you know which IRQ your mouse is using, you can enable the wake-up Event for that IRQ here and the system will wake up when you move the mouse or click its button.

.....

## **IRQ3 (device) to IRQ15 (device)**

You can individually *Enable* or *Disable* each IRQ to include in the sleep function. IRQ8 (RTC Alarm) is usually set to *Disable* so that any software alarm clock or event calendar can wake up the system.

# IV. BIOS SOFTWARE

## PNP and PCI Setup

This “PNP and PCI Setup” option configures the PCI bus slots. All PCI bus slots on the system use INTA#, thus all installed PCI cards must be set to this value.



**NOTE:** SETUP Defaults are noted in parenthesis next to each function heading.

### Details of PNP and PCI Setup

#### PNP OS Installed (No)

This field allows you to use a Plug-and-Play (PnP) operating system to configure the PCI bus slots instead of using the BIOS. Default setting is *No*.

#### Slot 1 (RIGHT) IRQ to Slot 4 (LEFT) IRQ (Auto)

These fields set how IRQ use is determined for each PCI slot. The default setting for each field is *Auto*, which uses auto-routing to determine IRQ use. The other options are manual settings of *NA*, *5*, *7*, *9*, *10*, *11*, *12*, *14* or *15* for each slot.

#### PCI Latency Timer (32 PCI Clock)

The default setting of *32 PCI Clock* enables maximum PCI performance for this motherboard.

#### IRQ xx Used By ISA (No/ICU)

These fields indicate whether or not the displayed IRQ for each field is being used by a legacy (non-PnP) ISA card. Two options are available: *No/ICU* (default) and *Yes*. *No/ICU* indicates either that the displayed IRQ is not used or an ISA Configuration Utility (ICU) is being used to determine if an ISA card is using that IRQ. If you install a legacy ISA card that requires a unique IRQ, and you are not using an ICU, you must set the field for that IRQ to *Yes*. For example: If you install a legacy ISA card that requires IRQ 10, then set **IRQ10 Used By ISA** to *Yes*.

.....

## IV. BIOS SOFTWARE

---

### **DMA x Used By ISA (No/ICU)**

These fields indicate whether or not the displayed DMA channel for each field is being used by a legacy (non-PnP) ISA card. Available options include: *No/ICU* and *Yes*. *No/ICU* indicates either that the displayed DMA channel is not used or an ICU is being used to determine if an ISA card is using that channel. If you install a legacy ISA card that requires a unique DMA channel, and you are not using an ICU, you must set the field for that channel to *Yes*.

### **ISA MEM Block BASE (No/ICU)**

This field allows you to set the base address and block size of a legacy ISA card that uses any memory segment within the C800H and DFFFH address range. If you have such a card, and you are not using an ICU to specify its address range, select a base address from the six available ranges. The **ISA MEM Block SIZE** field will then be available for selecting the block size. If you have more than one legacy ISA card in your system that requires to use this address range, you can increase the block size to either *8K*, *16K*, *36K*, or *64K*. If you are using an ICU to accomplish this task, leave **ISA MEM Block BASE** to its default setting of *No/ICU*.

### **SYMBIOS SCSI BIOS (Auto)**

The default uses *Auto* settings for the onboard SCSI BIOS. If you do not want to use the onboard SCSI BIOS, choose *Disabled*

### **USB Function (Disabled)**

The baseboard supports Universal Serial Bus (USB) devices but current operating systems do not. The default is set to *Disabled*. If you have the necessary support disks and USB devices, you can set this function to *Enabled* to use the onboard USB connector.

### **Passive Release (Enabled)**

This function allows the passive release to be *Enabled* or *Disabled*. The default setting of *Enabled* allows better performance.



# IV. BIOS SOFTWARE

## Load BIOS Defaults

This “Load BIOS Defaults” option allows you to load the troubleshooting default values permanently stored in the BIOS ROM. These default settings are non-optimal and disable all high performance features. To load these default settings, highlight “Load BIOS Defaults” on the main screen and then press <Enter>. The system displays a confirmation message on the screen. Press <Y> and then <Enter> to confirm. Press <N> and then <Enter> to abort. This feature does not affect the fields on the Standard CMOS Setup screen.

## Load Setup Defaults

This “Load Setup Defaults” option allows you to load the default values to the system configuration fields. These default values are the optimized configuration settings for the system. To load these default values, highlight “Load Setup Defaults” on the main screen and then press <Enter>. The system displays a confirmation message on the screen. Press <Y> and then <Enter> to confirm. Press <N> and then <Enter> to abort. This feature does not affect the fields on the Standard CMOS Setup screen.



IV. BIOS  
(Load Defaults)

**NOTE:** The SMART ALARM (LM78) SETUP is only available on baseboards with the optional onboard LM78 chip.

# IV. BIOS SOFTWARE

## Smart Alarm (LM78) Setup

**NOTE:** The SMART ALARM (LM78) SETUP is only available on baseboards with the optional onboard LM78 chip.

This menu requires that the baseboard contains the optional onboard LM78 hardware monitor chip. Certain hardware components are necessary for the all the smart alarm features to be available.



**NOTE:** SETUP Defaults are noted in parenthesis next to each function heading.

### Details of Smart Alarm (LM78) Setup

#### Fan Monitor: CPU1 Fan Speed / CPU2 Fan Speed / Power Fan Speed (xxxxRPM)

The onboard hardware monitor is able to detect the Chassis Fan Speed, CPU Fan Speed, and the Power Supply Fan Speed in Rotations Per Minute (RPM). These values refresh upon any key entry in the BIOS setup screens. Set to *Ignore* if one of these are not used so that error messages will not be given.

#### Thermal Monitor: MB Temperature (xxxC/xxxF)

The onboard hardware monitor can detect the baseboard temperatures. These values refresh upon key entries. Set to *Ignore* only if necessary.

#### Voltage Monitor: VCORE, +3.3V, +5V, +12V, -12V, -5V (+/- xx.xV)

The onboard hardware monitor can detect the voltages put out by the voltage regulators. These values refresh upon key entries. Set to *Ignore* only if necessary.

**NOTE:** If any of the monitored items are out of range during system bootup, you will be prompted by this message: “Hardware Monitor found an error, enter POWER MANAGEMENT SETUP for details.” The bottom of the screen will instruct you to “Press **F1** to continue, **DEL** to enter SETUP.”

# IV. BIOS SOFTWARE

## Supervisor Password and User Password

These two options set the system passwords. “Supervisor Password” sets a password that will be used to protect the system and the Setup utility; “User Password” sets a password that will be used exclusively on the system. By default, the system comes without any passwords. To specify a password, highlight the type you want and then press <Enter>. A password prompt appears on the screen. Taking note that the password is case sensitive, and can be up to 8 alphanumeric characters long, type in your password and then press <Enter>. The system confirms your password by asking you to type it again. After setting a password, the screen automatically reverts to the main screen.



**NOTE:** The SMART ALARM (LM78) SETUP is only available on baseboards with the optional onboard LM78 chip.

To implement the password protection, specify in the “Security Option” field of the BIOS Features Setup screen when the system will prompt for the password. If you want to disable either password, press <Enter> instead of entering a new password when the “Enter Password” prompt appears. A message confirms the password has been disabled.

**NOTE:** If you forget the password, see **Real Time Clock (RTC) RAM** in section III of the baseboard manual for procedures on clearing the CMOS.

IV. BIOS  
(Passwords)

# IV. BIOS SOFTWARE

## IDE HDD Auto Detection

The *IDE HDD Auto Detection* option detects the parameters of an IDE hard disk drive, and automatically enters them into the Standard CMOS Setup screen.

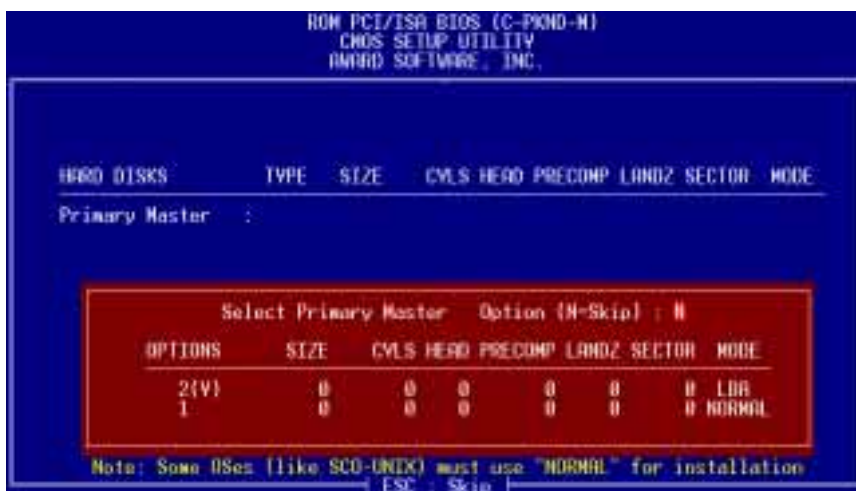

Up to four IDE drives can be detected (see , with parameters for each listed inside the box. To accept the optimal entries, press <Y>, otherwise, select from the OPTIONS listed (2, 1, 3 in this case); to skip to the next drive, press <N>. If you accept the values, the parameters will be listed beside the drive letter on the screen. The process then proceeds to the next drive letter. Pressing <N> to skip rather than to accept a set of parameters causes the program to enter zeros after that drive letter.

If you are using another IDE controller that does not feature Enhanced IDE support for four devices, you can only install two IDE hard disk drives. Your IDE controller must support the Enhanced IDE features to use Drive E and Drive F. The onboard PCI IDE controller supports Enhanced IDE, with two connectors for connecting up to four IDE devices. If you want to use another controller that supports four drives, you must disable the onboard IDE controller (see “Chipset Features Setup”).

When autodetection is completed, the program automatically enters all entries you accepted on the field for that drive in the Standard CMOS Setup screen. Skipped entries are ignored and are not entered in the screen.

If you are autodetecting a hard disk that supports the LBA mode, three lines will appear in the parameter box. Choose the line that lists LBA for an LBA drive. Do not select Large or Normal.

The autodetection feature can only detect one set of parameters for a particular IDE hard drive. Some IDE drives can use more than one set. This should not be a problem if the drive is new and contains nothing.

# IV. BIOS SOFTWARE

**IMPORTANT:** If your hard disk was already formatted on an older previous system, incorrect parameters may be detected. You will need to enter the correct parameters manually or use low-level format if you do not need the data stored on the hard disk.

If the parameters listed differ from the ones used when the disk was formatted, the disk will not be readable. If the autodetected parameters do not match the ones that should be used for your disk, do not accept them. Press <N> to reject the presented settings and enter the correct ones manually from the Standard CMOS Setup screen.

## Save & Exit Setup

Select this option to save into the CMOS memory all modifications you specified during the current session. To save the configuration changes, highlight the “Save & Exit Setup” option on the main screen and then press <Enter>.



**NOTE:** The SMART ALARM (LM78) SETUP is only available on baseboards with the optional onboard LM78 chip.

## Exit Without Saving

Select this option to exit the Setup utility without saving the modifications you specify during the current session. To exit without saving, highlight the “Exit Without Saving” option on the main screen and then press <Enter>.

V. DMI  
(Save & Exit)



# V. DESKTOP MANAGEMENT

---

## Desktop Management Interface (DMI)

### Introducing the ASUS DMI Configuration Utility

This motherboard supports DMI within the BIOS level and provides a DMI Configuration Utility to maintain the Management Information Format Database (MIFD). DMI is able to autodetect and record information pertinent to a computer's system, such as the CPU type, CPU speed, and internal/external frequencies, and memory size. The onboard BIOS will detect as many system information as possible and store the collected information in a 4K block in the baseboard's Flash EPROM and allows the DMI to retrieve data from this database. Unlike other BIOS software, the BIOS on the baseboard uses the same technology implemented for Plug and Play to allow dynamic real-time updating of DMI information versus creating a new BIOS image file and requiring the user to update the whole BIOS. This DMI Configuration Utility also allows the system integrator or end user to add additional information into the MIFD, such as serial numbers, housing configurations, and vendor information. Information not detected by the baseboard BIOS has to be manually entered through the DMI Configuration Utility and updated into the MIFD. This DMI Configuration Utility provides the same reliability as PnP updating and will prevent the refreshing failures associated with updating the entire BIOS.

### System Requirements

The DMI Configuration Utility (DMICFG.EXE) must be used in real mode for the program to run; the base memory must be at least 180K. Memory managers like HIMEM.SYS (required by Windows) must not be installed. You can either start your computer from a system disk without your AUTOEXEC.BAT and CONFIG.SYS files, comment out HIMEM.SYS in CONFIG.SYS by typing "REM" before the line, or press <F5> when the startup routines start to skip your AUTOEXEC.BAT and CONFIG.SYS files.



# V. DESKTOP MANAGEMENT

## Using the ASUS DMI Configuration Utility

*Edit DMI (or delete)*



To move the cursor or insertion point, use the <Left Arrow> or <Right Arrow> keys for the top menu items and the <Up Arrow> and <Down Arrow> keys for the left menu items. The lower part of the screen shows the available keys for each screen. Press <Enter> at the menu item to enter the right screen for editing. “Edit component” is displayed on top. The reversed color field is the current cursor position and texts in blue are available for editing. The orange text shows autodetected information and are not available for editing. Selecting “Press [ENTER] for detail” (in blue) displays a second pop-up menu. Use the <Plus Sign> or <Minus Sign> keys to change the settings. Press <Enter> to exit *and save* or press <ESC> to exit *and not save*.

If you made changes, pressing <ESC> prompts you to answer <Y> or <N>. Enter <Y> to go back to the left screen *and save*, enter <N> to go back to left screen *and not save*. If you made no changes, pressing <ESC> will send you back to the left menu without any messages.

### Notes

A heading, **\*\*\* BIOS Auto Detect \*\*\***, appears on the right for each menu item on the left side that has been autodetected by the system BIOS.

A heading, **\*\*\* User Modified \*\*\***, will appear on the right for menu items that has been modified by the user.



# V. DESKTOP MANAGEMENT

---

## Save MIFD



You can save the MIFD (normally only saved to flash ROM) to a file by entering the drive and path. If you want to cancel save, press <ESC> and a message “Bad File Name” is displayed to show it was not saved.

## Load MIFD



You can load the disk file to memory by entering the drive and path and filename.

## Load BIOS Defaults



You can load the BIOS defaults from a MIFD file and can clear all user modified and added data. You must restart your computer for the defaults to be saved back into the Flash BIOS.