

**ASUS® K7M-RM**

Slot A Motherboard

**USER'S MANUAL**

# USER'S NOTICE

---

No part of this manual, including the products and software described in it, may be reproduced, transmitted, transcribed, stored in a retrieval system, or translated into any language in any form or by any means, except documentation kept by the purchaser for backup purposes, without the express written permission of ASUSTeK COMPUTER INC. ("ASUS").

ASUS PROVIDES THIS MANUAL "AS IS" WITHOUT WARRANTY OF ANY KIND, EITHER EXPRESS OR IMPLIED, INCLUDING BUT NOT LIMITED TO THE IMPLIED WARRANTIES OR CONDITIONS OF MERCHANTABILITY OR FITNESS FOR A PARTICULAR PURPOSE. IN NO EVENT SHALL ASUS, ITS DIRECTORS, OFFICERS, EMPLOYEES OR AGENTS BE LIABLE FOR ANY INDIRECT, SPECIAL, INCIDENTAL, OR CONSEQUENTIAL DAMAGES (INCLUDING DAMAGES FOR LOSS OF PROFITS, LOSS OF BUSINESS, LOSS OF USE OR DATA, INTERRUPTION OF BUSINESS AND THE LIKE), EVEN IF ASUS HAS BEEN ADVISED OF THE POSSIBILITY OF SUCH DAMAGES ARISING FROM ANY DEFECT OR ERROR IN THIS MANUAL OR PRODUCT.

Product warranty or service will not be extended if: (1) the product is repaired, modified or altered, unless such repair, modification or alteration is authorized in writing by ASUS; or (2) the serial number of the product is defaced or missing.

Products and corporate names appearing in this manual may or may not be registered trademarks or copyrights of their respective companies, and are used only for identification or explanation and to the owners' benefit, without intent to infringe.

- AMD, Athlon™, K7, and/or combinations thereof are trademarks of Advanced Micro Devices, Inc.
- VIA is a trademark of VIA Technologies, Inc.
- Windows and MS-DOS are registered trademarks of Microsoft Corporation.
- Adobe and Acrobat are registered trademarks of Adobe Systems Incorporated.
- Trend and ChipAwayVirus are trademarks of Trend Micro, Inc.

The product name and revision number are both printed on the product itself. Manual revisions are released for each product design represented by the digit before and after the period of the manual revision number. Manual updates are represented by the third digit in the manual revision number.

For previous or updated manuals, BIOS, drivers, or product release information, contact ASUS at <http://www.asus.com.tw> or through any of the means indicated on the following page.

SPECIFICATIONS AND INFORMATION CONTAINED IN THIS MANUAL ARE FURNISHED FOR INFORMATIONAL USE ONLY, AND ARE SUBJECT TO CHANGE AT ANY TIME WITHOUT NOTICE, AND SHOULD NOT BE CONSTRUED AS A COMMITMENT BY ASUS. ASUS ASSUMES NO RESPONSIBILITY OR LIABILITY FOR ANY ERRORS OR INACCURACIES THAT MAY APPEAR IN THIS MANUAL, INCLUDING THE PRODUCTS AND SOFTWARE DESCRIBED IN IT.

**Copyright © 2000 ASUSTeK COMPUTER INC. All Rights Reserved.**

Product Name: **K7M-RM**  
Manual Revision: **1.03 E501**  
Release Date: **January 2000**

# ASUS CONTACT INFORMATION

---

## ASUSTeK COMPUTER INC. (Asia-Pacific)

### *Marketing*

Address: 150 Li-Te Road, Peitou, Taipei, Taiwan 112  
Telephone: +886-2-2894-3447  
Fax: +886-2-2894-3449  
Email: info@asus.com.tw

### *Technical Support*

MB/Others (Tel): +886-2-2890-7121 (English)  
Notebook (Tel): +886-2-2890-7122 (English)  
Desktop/Server (Tel): +886-2-2890-7123 (English)  
Fax: +886-2-2895-9254  
Email: tsd@asus.com.tw  
WWW: www.asus.com.tw  
FTP: ftp.asus.com.tw/pub/ASUS

## ASUS COMPUTER INTERNATIONAL (America)

### *Marketing*

Address: 6737 Mowry Avenue, Mowry Business Center, Building 2  
Newark, CA 94560, USA  
Fax: +1-510-608-4555  
Email: tmd1@asus.com

### *Technical Support*

Fax: +1-510-608-4555  
BBS: +1-510-739-3774  
Email: tsd@asus.com  
WWW: www.asus.com  
FTP: ftp.asus.com/Pub/ASUS

## ASUS COMPUTER GmbH (Europe)

### *Marketing*

Address: Harkortstr. 25, 40880 Ratingen, BRD, Germany  
Fax: +49-2102-442066  
Email: sales@asuscom.de (for marketing requests only)

### *Technical Support*

Hotline: MB/Others: +49-2102-9599-0 Notebook: +49-2102-9599-10  
Fax: +49-2102-9599-11  
Support (Email): www.asuscom.de/de/support (for online support)  
WWW: www.asuscom.de  
FTP: ftp.asuscom.de/pub/ASUSCOM

# CONTENTS

---

<b>1. INTRODUCTION .....</b>	<b>7</b>
1.1 How This Manual Is Organized .....	7
1.2 Item Checklist .....	7
<b>2. FEATURES .....</b>	<b>8</b>
2.1 The ASUS K7M-RM Motherboard .....	8
2.1.1 Specifications .....	8
2.1.1.1 Optional Components .....	9
2.1.2 Performance .....	10
2.1.3 Intelligence (only with optional hardware monitor) .....	11
2.2 K7M-RM Components .....	12
<b>3. HARDWARE SETUP .....</b>	<b>14</b>
3.1 K7M-RM Motherboard Layout .....	14
3.2 Layout Contents .....	15
3.3 Hardware Setup Procedure .....	17
3.4 Motherboard Settings .....	17
3.5 System Memory (DIMM) .....	22
3.5.1 General DIMM Notes .....	22
3.5.2 DIMM Memory Installation .....	23
3.6 Central Processing Unit (CPU) .....	25
3.6.1 Universal Retention Mechanism .....	25
3.6.2 Heatsinks .....	25
3.6.3 Installing the Processor .....	26
3.6.4 Smart Thermal Solutions .....	28
3.6.5 Recommended Heatsinks for Slot A Processors .....	29
3.7 Expansion Cards .....	31
3.7.1 Expansion Card Installation Procedure .....	31
3.7.2 Assigning IRQs for Expansion Cards .....	31
3.7.3 Accelerated Graphics Port (AGP) Pro .....	33
3.7.4 Audio Modem Riser (AMR) Slot .....	33
3.8 External Connectors .....	34
3.9 Power Connection Procedures .....	45
<b>4. BIOS SETUP .....</b>	<b>46</b>
4.1 Managing and Updating Your BIOS .....	46
4.1.1 Upon First Use of the Computer System .....	46
4.1.2 Updating BIOS Procedures .....	48

# CONTENTS

---

4.2	BIOS Setup Program .....	49
4.2.1	BIOS Menu Bar .....	50
4.2.2	Navigation Keys .....	50
4.3	Main Menu .....	52
4.3.1	Primary & Secondary IDE Master/Slave .....	53
4.4	Advanced Menu .....	55
4.4.1	Advanced CMOS Setup .....	56
4.4.2	Advanced Chipset Setup .....	59
4.4.3	Power Management Setup .....	61
4.4.4	Plug and Play Setup .....	64
4.4.5	Peripheral Setup .....	66
4.4.6	Hardware Monitor Setup .....	68
4.5	Security Menu .....	69
4.6	Exit Menu .....	70
<b>5.</b>	<b>SOFTWARE SETUP .....</b>	<b>71</b>
5.1	Operating Systems .....	71
5.1.1	Windows 98 First Time Installation .....	71
5.2	K7M-RM Support CD .....	72
5.3	Audio Driver (only with onboard audio option) .....	73
5.4	PC-cillin 98 .....	74
5.5	Acrobat Reader Vx.x .....	75
5.6	IDE Driver .....	76
5.7	Miniport Driver .....	77
5.8	ASUS PC Probe .....	78
5.9	YAMAHA S-YXG50 .....	79
5.10	YAMAHA XGStudio .....	80
5.11	Uninstalling Programs .....	81
<b>6.</b>	<b>SOFTWARE REFERENCE .....</b>	<b>83</b>
6.1	ASUS PC Probe .....	83
6.2	Using YAMAHA XGPlayer .....	89
6.3	Using YAMAHA XGstudio Mixer .....	91
<b>7.</b>	<b>APPENDIX .....</b>	<b>93</b>
7.1	ASUS PCI-L101 Fast Ethernet Card .....	93

# FCC & DOC COMPLIANCE

---

## ***Federal Communications Commission Statement***

This device complies with FCC Rules Part 15. Operation is subject to the following two conditions:

- This device may not cause harmful interference, and
- This device must accept any interference received, including interference that may cause undesired operation.

This equipment has been tested and found to comply with the limits for a Class B digital device, pursuant to Part 15 of the FCC Rules. These limits are designed to provide reasonable protection against harmful interference in a residential installation. This equipment generates, uses and can radiate radio frequency energy and, if not installed and used in accordance with manufacturer's instructions, may cause harmful interference to radio communications. However, there is no guarantee that interference will not occur in a particular installation. If this equipment does cause harmful interference to radio or television reception, which can be determined by turning the equipment off and on, the user is encouraged to try to correct the interference by one or more of the following measures:

- Re-orient or relocate the receiving antenna.
- Increase the separation between the equipment and receiver.
- Connect the equipment to an outlet on a circuit different from that to which the receiver is connected.
- Consult the dealer or an experienced radio/TV technician for help.

**WARNING!** Any changes or modifications to this product not expressly approved by the manufacturer could void any assurances of safety or performance and could result in violation of Part 15 of the FCC Rules.

Reprinted from the Code of Federal Regulations #47, part 15.193, 1993. Washington DC: Office of the Federal Register, National Archives and Records Administration, U.S. Government Printing Office.

## ***Canadian Department of Communications Statement***

This digital apparatus does not exceed the Class B limits for radio noise emissions from digital apparatus set out in the Radio Interference Regulations of the Canadian Department of Communications.

**This Class B digital apparatus complies with Canadian ICES-003.**

**Cet appareil numérique de la classe B est conforme à la norme NMB-003 du Canada.**

# 1. INTRODUCTION

## 1.1 How This Manual Is Organized

This manual is divided into the following sections:

- |                       |                                                  |
|-----------------------|--------------------------------------------------|
| 1. INTRODUCTION       | Manual information and checklist                 |
| 2. FEATURES           | Product information and specifications           |
| 3. HARDWARE SETUP     | Instructions on setting up the motherboard       |
| 4. BIOS SETUP         | Instructions on setting up the BIOS software     |
| 5. SOFTWARE SETUP     | Instructions on setting up the included software |
| 6. SOFTWARE REFERENCE | Reference material for the included software     |
| 7. APPENDIX           | Optional items and general reference             |

## 1.2 Item Checklist

Check that your package is complete. If you discover damaged or missing items, please contact your retailer.

### 1.2.1 Motherboard

- (1) ASUS Motherboard
- (1) Universal Retention Mechanism (factory installed)
- (1) ASUS USB Connector Set
- (1) Ribbon cable for master and slave UltraDMA/33 & UltraDMA/66 IDE drives
- (1) Ribbon cable for (1) 3.5" floppy disk drive
- (1) Bag of spare jumper caps
- (1) Support CD with drivers and utilities
- (1) This Motherboard User's Manual
- ASUS IrDA-compliant infrared module (optional)
- ASUS PCI-L101 Wake-On-LAN 10/100 Fast Ethernet Card (optional)

**IMPORTANT:** It is strongly recommended that at least a 200-watt (235W for full configuration) ATX power supply be used for this motherboard. Make sure that your ATX power supply can supply at least 20 amperes on the +5-volt lead and 10mA on the +5-volt standby lead (+5VSB) (see **19) ATX Power Supply Connector** in **3.8 External Connectors**). Your system may become unstable/unreliable and may experience difficulty in powering up if your power supply is inadequate.

## 2. FEATURES

---

### 2.1 The ASUS K7M-RM Motherboard

The ASUS K7M-RM motherboard is carefully designed for the demanding PC user who wants high-performance features in a small package.

#### 2.1.1 Specifications

- **AMD Athlon™ Processor Support:** Supports AMD Athlon™ processor designed for the AMD Athlon™ Processor Module (242-pin Slot A).
- **North Bridge System Chipset:** AMD-751™ chipset with AGP/PCI/Memory controller supports a 200MHz Front Side Bus (FSB), supports up to 768MB of PC-100 SDRAM DIMM, complies with AGP 2.0 specifications for 1X and 2X AGP modes and PCI 2.2. bus interface with support for 3 PCI masters. It is optimized to deliver enhanced AMD Athlon™ processor system performance.
- **South Bridge System Chipset:** VIA VT82C686A PCIset with PCI Super I/O integrated peripheral controller supports UltraDMA/66, which allows burst mode data transfer rates of up to 66.6MB/sec.
- **Enhanced ACPI & Anti-Boot Virus BIOS:** Programmable BIOS (Flash EEPROM), offering enhanced ACPI for Windows 98 compatibility, built-in firmware-based virus protection, and autodetection of most devices for virtually automatic setup.
- **PC100 Memory Support:** Equipped with three DIMM sockets to support Intel PC100-compliant SDRAMs (16, 32, 64, 128, or 256MB) up to 768MB.
- **Thermal Sensor Connector with Optional Sensor:** Accurately detects the CPU temperature with the ASUS Smart Fan when connected to an ASUS P2T-Cable.
- **Super Multi-I/O:** Provides two high-speed UART compatible serial ports and one parallel port with EPP and ECP capabilities.
- **Expansion Slots:** Provides three 32-bit PCI 2.2, one AGP, and one AMR (AMR shared with one PCI) expansion slots. PCI supports up to 133MB/sec maximum throughput. Each PCI slot can support a Bus Master PCI card, such as a SCSI card.
- **Desktop Management Interface (DMI):** Supports DMI through BIOS, which allows hardware to communicate within a standard protocol creating a higher level of compatibility. (Requires DMI-enabled components.)
- **Wake-Up Support:** Supports Wake-On-LAN and Wake-On-Ring.
- **AMR Slot:** Audio Modem Riser (AMR) slot supports a very affordable audio and/or modem riser card. (Only an ISA-side AMR card can be used.)
- **AGP Slot:** Supports an Accelerated Graphics Port card for high performance component level interconnect targeted at 3D graphical display applications using a 1X or 2X mode bus.
- **USB:** Supports up to 4 USB ports, two on the back panel and two midboard (optional), for more peripheral connectivity options.



## 2. FEATURES

---

- **UltraDMA/66 & UltraDMA/33:** Comes with an onboard PCI Bus Master IDE controller with two connectors that support four IDE devices on two channels. Supports UltraDMA/66, UltraDMA/33, PIO Modes 3 & 4 and Bus Master IDE DMA Mode 2, and Enhanced IDE devices, such as DVD-ROM, CD-ROM, CD-R/RW, LS-120, and Tape Backup drives.
- **Smart BIOS:** 2Mb firmware gives a new easy-to-use interface that provides more control and protection over the motherboard. Provides CPU/SDRAM frequency adjustments, and HD/SCSI/ZIP/CD/Floppy/Network boot selection.
- **Color-coded Connectors:** To enhance user accessibility to system components and to meet PC 99 compliancy, major connectors in this motherboard are color-coded.

### 2.1.1.1 Optional Components

The following onboard components are optional at the time of purchase.

- **Onboard Audio:** Hardware AC'97 V2.1 CODEC compliant, Analog Device's 3D sound circuitry, sample rate conversion from 7kHz to 48kHz. Full audio output can be directed to the chassis' internal speaker to save space, save money, and reduce complications associated with external speakers.
- **Infrared Interface:** Integrated Serial Infrared interface supports an optional remote control package for wireless interfacing with external peripherals, personal gadgets, or an optional remote controller.
- **PC Health Monitoring:** Provides an easy way to examine and manage system status information, such as CPU and system voltages, temperatures, and fan status through the onboard hardware ASIC and the bundled ASUS PC Probe.
- **Additional USB Ports:** For more peripheral connectivity, two additional USB ports are supported midboard.

## 2. FEATURES

---

### 2.1.2 Performance

- **100/100MHz Synchronous Host/DRAM Clock Support:** CPU frequency can operate at 100MHz while system memory operates at 100MHz.
- **High-Speed Data Transfer Interface:** This motherboard with its chipset and support for UltraDMA/66 doubles the UltraDMA/33 burst transfer rate to 66.6MB/s. UltraDMA/66 is backward compatible with both DMA/33 and DMA and with existing DMA devices and systems so there is no need to upgrade current EIDE/IDE drives and host systems. (UltraDMA/66 requires a 40-pin 80-conductor cable to be enabled and/or for UltraDMA Mode 4.)
- **Concurrent PCI:** Concurrent PCI allows multiple PCI transfers from PCI master buses to memory to CPU.
- **SDRAM Optimized Performance:** This motherboard supports the new generation memory, Synchronous Dynamic Random Access Memory (SDRAM), which increases the data transfer rate to 800MB/s max using PC100-compliant SDRAM.
- **ACPI Ready:** ACPI (Advanced Configuration and Power Interface) provides more Energy Saving Features for future operating systems (OS) supporting OS Direct Power Management (OSPM) functionality. With these features implemented in the OS, PCs can be ready around the clock, yet satisfy all the energy saving standards. To fully utilize the benefits of ACPI, an ACPI-supported OS, such as Windows 98, must be used.
- **PC 99 Compliancy:** Both the BIOS and hardware levels of the motherboard meets PC 99 compliancy. The new PC 99 requirements for systems and components are based on the following high-level goals: Support for Plug and Play compatibility and power management for configuring and managing all system components, and 32-bit device drivers and installation procedures for Windows 95/98/NT.

## 2. FEATURES

---

### 2.1.3 Intelligence (only with optional hardware monitor)

- **Fan Status Monitoring and Alarm:** To prevent system overheat and system damage, the CPU, power supply, and system fans can be monitored for RPM and failure. All the fans are set for its normal RPM range and alarm thresholds.
- **Voltage Monitoring and Alert:** Processor and system voltage levels are monitored to ensure stable current to critical motherboard components. Voltage specifications are more critical for future processors, so monitoring is necessary to ensure proper system configuration and management.
- **Auto Fan Off:** The system fans will power off automatically **even in sleep mode**. This function reduces both energy consumption and **system noise**, and is an important feature to implement silent PC systems.
- **Remote Ring On (requires modem):** This allows a computer with this motherboard to be turned on remotely through an internal or external modem. With this feature, users can access their computer from anywhere in the world!

# 2. FEATURES

## 2.2 K7M-RM Motherboard Components

See opposite page for locations.

	<b>Location</b>
<b>Processor Support</b>	Slot A for AMD Athlon™ Processors ..... 1
	Frequency Selection DIP Switches ..... 11
<b>Chipsets</b>	AMD-751™ AGP/PCI/Memory Controller ..... 2
	VIA South Bridge (PCI Super I/O Integrated Peripheral Controller) ..... 10
	Programmable Flash EEPROM ..... 8
<b>Main Memory</b>	Maximum 768MB support 3 DIMM Sockets ..... 3
	PC100 SDRAM support
<b>Expansion Slots</b>	3 PCI Slots ..... 16
	1 AGP Slot ..... 17
	1 Audio Modem Riser (AMR) Slot ..... 14
<b>System I/O</b>	2 IDE Connectors (UltraDMA33/66 Support) ..... 5
	1 Floppy Disk Driver Connector ..... 6
	1 Serial COM1 Connector ..... 21
	1 Serial COM2 Connector ..... 19
	1 Parallel Port Connector ..... 20
	USB Connectors (Port 0 & Port 1) ..... 22
	USB Connectors (Port 2 & Port 3) (optional) ..... 7
	1 PS/2 Mouse Connector ..... (Top) 23
	1 PS/2 Keyboard Connector ..... (Bottom) 23
<b>3D Graphics</b>	AMD-751™ AGP/PCI/Memory Controller ..... 2
<b>Audio</b>	AC'97 V2.1 Audio Codec (optional) ..... 15
	1 Joystick/MIDI Connector (on audio model only) .... (Top ) 18
	1 Line Out Connector (on audio model only) ..... (Bottom) 18
	1 Line In Connector (on audio model only) ..... (Bottom) 18
	1 Microphone Connector (on audio model only) ... (Bottom) 18
<b>Network Features</b>	Wake-On-LAN Connector ..... 12
	Wake-On-Ring Connector ..... 13
<b>Hardware Monitoring</b>	Hardware Monitor Chip ..... 9
	3 Fan Power and Speed Monitoring Connectors
<b>Power</b>	ATX Power Supply Connector ..... 4
<b>Form Factor</b>	microATX, 244mm x 244mm (9.6" x 9.6")

# 2. FEATURES

## *K7M-RM Motherboard Component Locations*

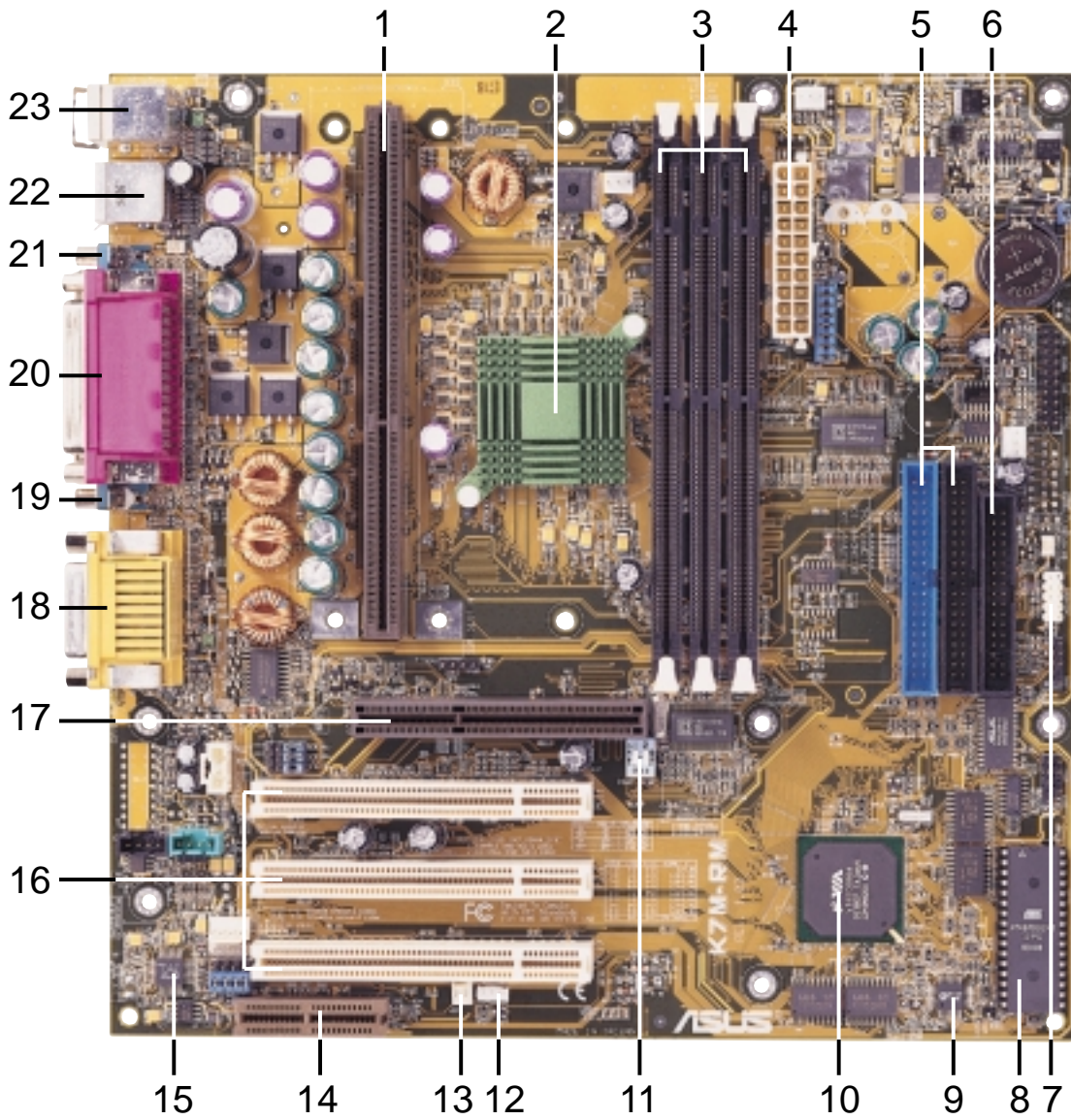

**2. FEATURES**  
Component Locations

# 3. HARDWARE SETUP

## 3.1 K7M-RM Motherboard Layout

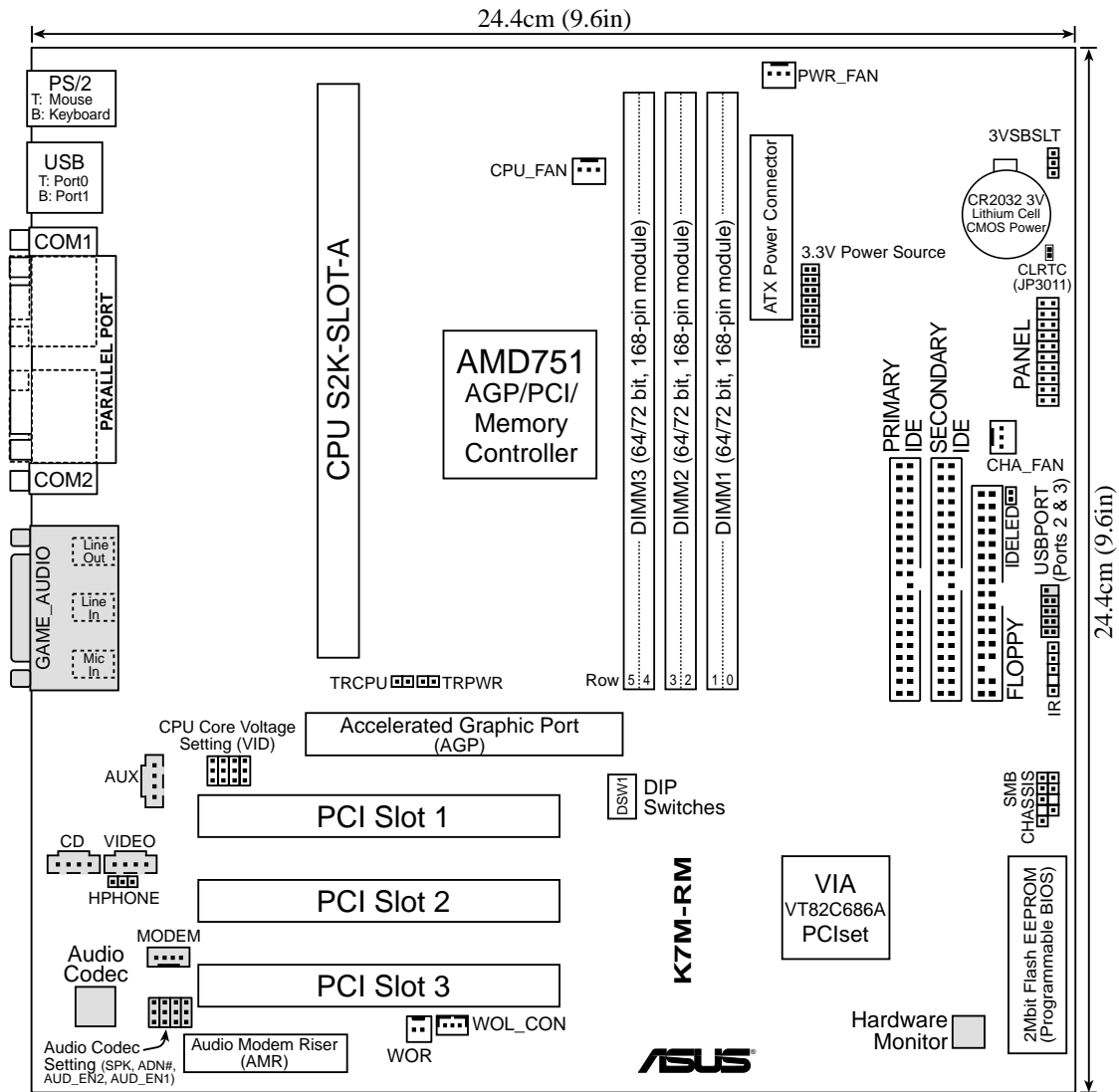

Grayed items are optional at the time of purchase.

3. HW SETUP  
Motherboard Layout

# 3. HARDWARE SETUP

## 3.2 Layout Contents

### Motherboard Settings

- |                          |                                                   |
|--------------------------|---------------------------------------------------|
| 1) 3VSBSLT               | p.18 Vaux Setting (+3V/+3VSB)                     |
| 2) JP3001–JP3008         | p.18 3.3V Power Source Setting                    |
| 3) SPK/AUD_EN1/_EN2/ADN# | p.19 Onboard Audio Setting (Enable.../Disable...) |
| 4) DSW1                  | p.20 CPU External Frequency Setting               |
| 5) VID1, VID2, VID3      | p.21 Voltage Regulator Output Setting             |

### Expansion Slots

- |                        |                                     |
|------------------------|-------------------------------------|
| 1) DIMM1, DIMM2, DIMM3 | p.22 168-Pin DIMM Memory Support    |
| 2) Slot A              | p.25 Central Processing Unit (CPU)  |
| 3) PCI1, PCI2, PCI3    | p.31 32-bit PCI Bus Expansion Slots |
| 4) AGP                 | p.33 Accelerated Graphics Port      |
| 5) AMR                 | p.33 Audio Modem Riser Slot         |

### Connectors

- |                           |                                                               |
|---------------------------|---------------------------------------------------------------|
| 1) PS2KBMS                | p.34 PS/2 Mouse Connector (6-pin female)                      |
| 2) PS2KBMS                | p.34 PS/2 Keyboard Connector (6-pin female)                   |
| 3) USB                    | p.35 Universal Serial Bus Ports 0 & 1 (Two 4-pin female)      |
| 4) PRINTER                | p.35 Parallel Port Connector (25-pin female)                  |
| 5) COM1, COM2             | p.35 Serial Port Connectors (Two 9-pin male)                  |
| 6) GAME_AUDIO             | p.36 Joystick/MIDI Connector (15-pin female) (optional)       |
| 7) GAME_AUDIO             | p.36 Audio Port Connectors (Three 1/8" female) (optional)     |
| 8) PRIMARY/SECONDARYIDE   | p.37 Primary/Secondary IDE Connectors (Two 40-1pins)          |
| 9) FLOPPY                 | p.37 Floppy Disk Drive Connector (34-1pins)                   |
| 10) WOL_CON               | p.38 Wake-On-LAN Connector (3 pins)                           |
| 11) WOR                   | p.38 Wake-On-Ring Connector (2 pins)                          |
| 12) IDE LED               | p.39 IDE Activity LED (2 pins)                                |
| 13) PWR_, CPU_, CHA_FAN   | p.39 Power Supply, CPU, Chassis Fan Connectors (Three 3-pin)  |
| 14) CD, AUX, VIDEO, MODEM | p.40 Internal Audio Connectors (Four 4-pins) (optional)       |
| 15) HPHONE                | p.40 Headphone True-Level Line Out Header (3-pins) (optional) |
| 16) IR                    | p.41 Serial Infrared Module Connector (5-1 pins)              |
| 17) SMB                   | p.41 SMBus Connector (5-1 pins)                               |
| 18) CHASSIS               | p.42 Chassis Intrusion Alarm Lead (4-1 pins)                  |
| 19) ATXPWR                | p.42 ATX Power Supply Connector (20 pins)                     |
| 20) USBPORT               | p.43 USB Connector Set (10-1 pins)                            |
| 21) SPEAKER (PANEL)       | p.44 System Warning Speaker Connector (4 pins)                |
| 22) PWRLED (PANEL)        | p.44 System Power LED Lead (3-1 pins)                         |

# 3. HARDWARE SETUP

---

- |                   |                                                       |
|-------------------|-------------------------------------------------------|
| 23) RESET (PANEL) | p.44 Reset Switch Lead (2 pins)                       |
| 24) PWRSW (PANEL) | p.44 ATX Power / Soft-Off Switch Lead (2 pins)        |
| 25) SMI (PANEL)   | p.44 System Management Interrupt Switch Lead (2 pins) |



# 3. HARDWARE SETUP

## 3.3 Hardware Setup Procedure

Before using your computer, you must complete the following steps:

- Check Motherboard Settings
- Install Memory Modules
- Install the Central Processing Unit (CPU)
- Install Expansion Cards
- Connect Ribbon Cables, Panel Wires, and Power Supply

## 3.4 Motherboard Settings

This section explains in detail how to change your motherboard's function settings through the use of switches and/or jumpers.

**WARNING!** Computer motherboards and expansion cards contain very delicate Integrated Circuit (IC) chips. To protect them against damage from static electricity, you should follow some precautions whenever you work on your computer.

1. Unplug your computer when working on the inside.
2. Use a grounded wrist strap before handling computer components. If you do not have one, touch both of your hands to a safely grounded object or to a metal object, such as the power supply case.
3. Hold components by the edges and try not to touch the IC chips, leads or connectors, or other components.
4. Place components on a grounded antistatic pad or on the bag that came with the component whenever the components are separated from the system.
5. Ensure that the ATX power supply is switched off before you plug in or remove the ATX power connector on the motherboard.

### Motherboard Feature Settings (DSW)

Besides jumper settings, some of the motherboard's onboard functions are adjusted through the DIP switches. The white block represents the switch's position. The example below shows all the switches in the OFF position.

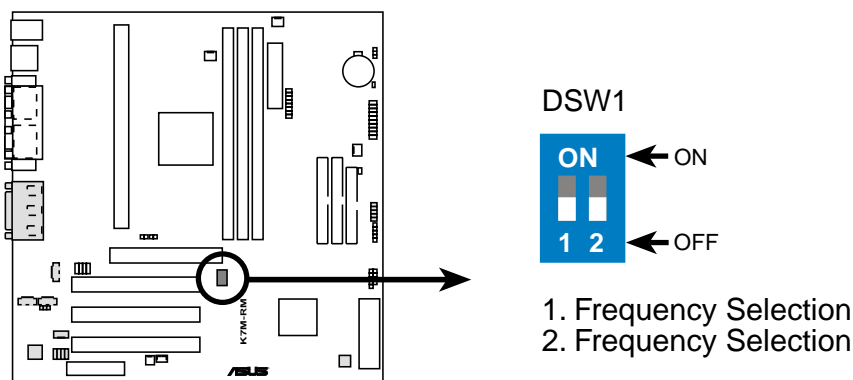

K7M-RM DIP Switches

# 3. HARDWARE SETUP

## 1) PCI 3Volt Setting (3VSBSLT)

This jumper allows you to select the voltage supplied to PCI devices. If you have PCI devices that require auxiliary power, set this jumper to 3 VSB.

<b>Setting</b>	<b>3VSBSLT</b>
3 Volt	[1-2]
3 VSB	[2-3] (default)

## 2) 3.3V Power Source Setting (JP3001–JP3008) (Requires optional components.)

This jumper lets you select the onboard 3.3V from the motherboard if your ATX power supply does not have a 3.3V lead and 3.3V optional components are mounted on the motherboard. This motherboard normally does not have the 3.3V components and therefore requires a standard ATX power supply with its own 3.3V lead.

<b>Setting</b>	<b>JP3001-JP3008</b>
3.3V from PWR	[1-2] (default)
3.3V from MB	[0-0]

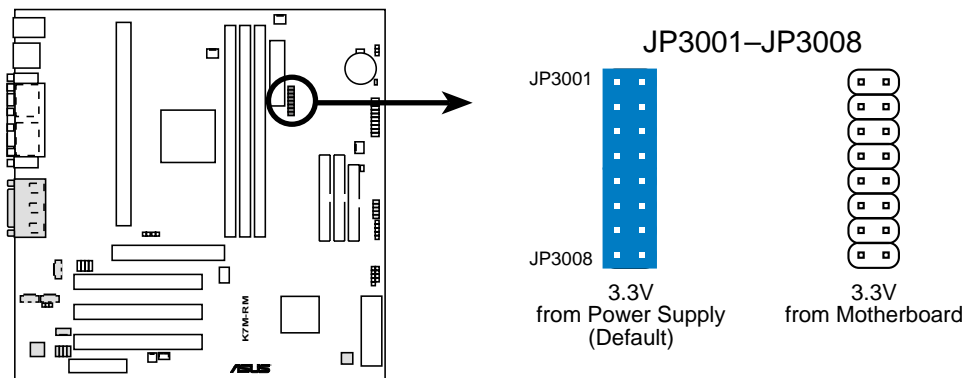

**K7M-RM 3.3V Power Source Setting**

# 3. HARDWARE SETUP

## 3) Onboard Audio Setting (available on audio model only)

The onboard audio CODEC may be enabled or disabled using all of these jumpers. Disable the onboard audio CODEC if you are using an PCI audio card on any of the expansion slots or a primary AMR on the AMR slot (see AMR Slot later in this section). If using an PCI audio expansion card, **Onboard AC'97 Audio Controller** in *4.4.5 Peripheral Setup* must also be disabled.

Setting	AUDIO CODEC
Enable	[1-2] [1-2] [1-2] [1-2] (default)
Disable	[2-3] [2-3] [2-3] [2-3]

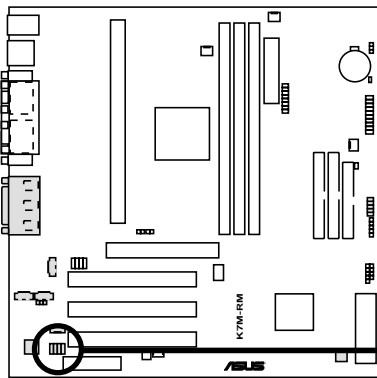

K7M-RM Audio Codec Setting

Enable  
Onboard  
Audio Codec  
(Default)

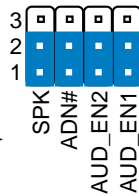

Disable  
Onboard  
Audio Codec

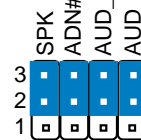

# 3. HARDWARE SETUP

## 4) CPU External Frequency Setting (DSW)

This option tells the clock generator what frequency to send to the CPU, SDRAM, and the chipset. This allows the selection of the CPU's *External* frequency. The CPU External Frequency multiplied by the Frequency Multiple equals the CPU's *Internal* frequency (the advertised CPU speed). The CPU is running at the same speed as the SDRAM.

**NOTE:** To use this feature, **CPU Frequency Selection** in BIOS setup must be set to [By Jumper] (see **4.4.2 Advanced Chipset Setup**).

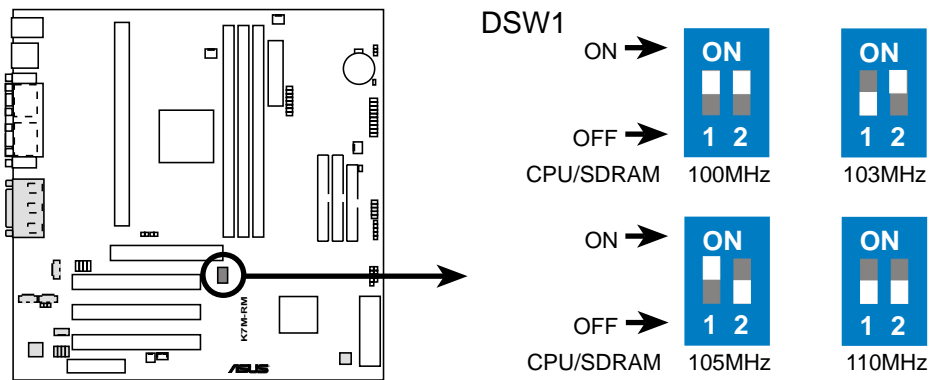

**K7M-RM CPU External Frequency Selection**

**NOTE:** Frequency Multiple settings are not available here because AMD Athlon™ processors have locked Frequency Multiples.

**NOTE:** The motherboard supports PC100 / PC133 DIMMs for system memory.

# 3. HARDWARE SETUP

## External Frequency Table

CPU (MHz)	SDRAM (MHz)	Frequency Selection Switches	
		1	2
100.00	100.00	[ON]	[ON]
103.00	103.00	[OFF]	[ON]
105.00	105.00	[ON]	[OFF]
110.00	110.00	[OFF]	[OFF]

**NOTE:** For updated processor settings, visit the ASUS web site (see **ASUS CONTACT INFORMATION**).

**WARNING!** Premature wearing of the processor may result when overclocking. Be sure that the DIMM you use can handle the specified SDRAM MHz or else bootup will not be possible.

### 5) Voltage Regulator Output Setting (VID1, VID2, VID3)

This jumpers allow you to manually adjust the CPU core voltage. It is recommended to use **CPU Default** as the CPU core voltage. **CPU Default** means the Vcore is generated according to the CPU VID configuration. For each jumper setting, there are two voltage options, depending on the CPU used.

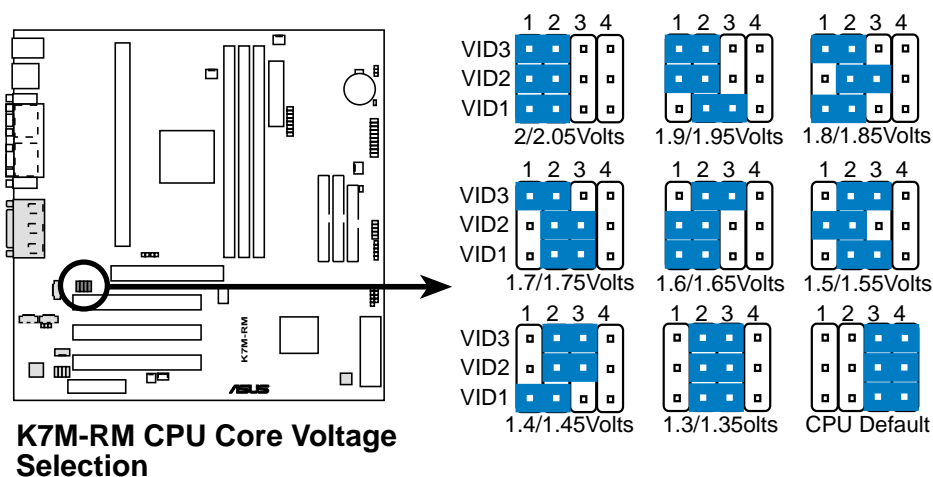

# 3. HARDWARE SETUP

## 3.5 System Memory (DIMM)

**NOTE:** No hardware or BIOS setup is required after adding or removing memory.

This motherboard uses only Dual Inline Memory Modules (DIMMs). Sockets are available for **3.3Volt** (power level) unbuffered Synchronous Dynamic Random Access Memory (SDRAM) of 16, 32, 64, 128MB, or 256MB. to form a memory size between 16MB and 768MB. One side (with memory chips) of the DIMM takes up one row on the motherboard.

To use the chipset's Error Checking and Correction (ECC) feature, you must use a DIMM with 9 chips per side (standard 8 chips/side + 1 ECC chip).

Memory speed setup is recommended through **Configure SDRAM Timing by SPD** (see **4.4.2 Advanced Chipset Setup**).

*Install memory in any combination as follows:*

**IMPORTANT:** DIMMs must be inserted in the following sequence: DIMM1, DIMM2, DIMM3. That is, if you intend to initially use one DIMM, use DIMM1 first. Then when you are ready for a second DIMM, use DIMM2, and so on. If this sequence is not followed, system instability may be experienced.

Location	168-pin DIMM		Total Memory
DIMM1 (Rows 0&1)	SDRAM 16, 32, 64, 128, 256MB	x1	
DIMM2 (Rows 2&3)	SDRAM 16, 32, 64, 128, 256MB	x1	
DIMM3 (Rows 4&5)	SDRAM 16, 32, 64, 128, 256MB	x1	
	<b>Total System Memory (Max 768MB)</b>	=	

### 3.5.1 General DIMM Notes

- When this motherboard operates at 100MHz, PC100-compliant modules must be used because of the strict timing issues involved under this speed.
- This motherboard supports SPD (Serial Presence Detect) DIMMs. This is the memory of choice for best performance vs. stability.
- This motherboard does NOT support registered memory.
- SDRAM chips are generally thinner with higher pin density than EDO (Extended Data Output) chips.
- BIOS shows SDRAM memory on bootup screen.
- Single-sided DIMMs come in 16, 32, 64,128MB; double-sided come in 32, 64, 128, 256MB.

# 3. HARDWARE SETUP

## 3.5.2 DIMM Memory Installation

Insert the module(s) as shown. Because the number of pins are different on either side of the breaks, the module will only fit in the orientation shown. DIMM modules are longer and have different pin contact on each side and therefore have a higher pin density. SIMM modules have the same pin contact on both sides.

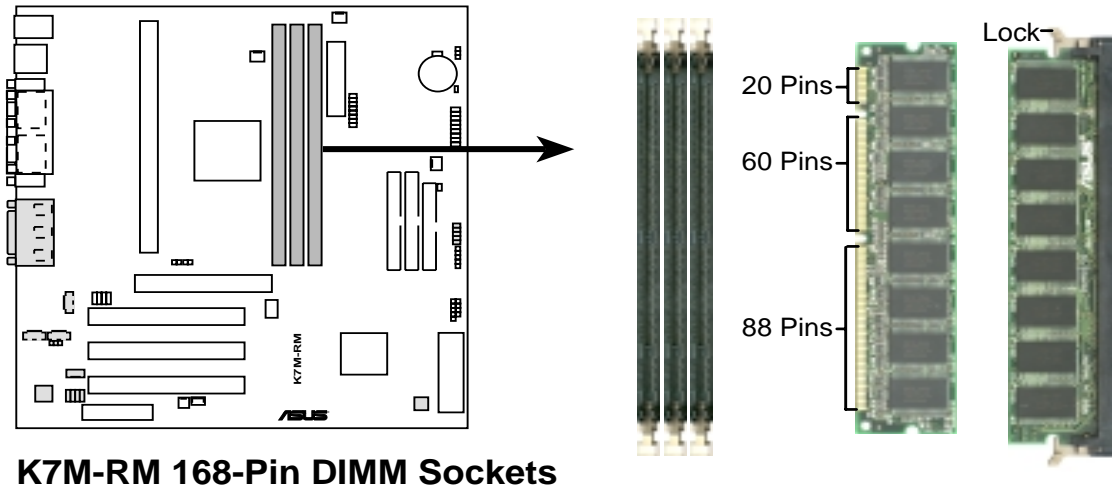

**K7M-RM 168-Pin DIMM Sockets**

The DIMMs must be **3.3V Unbuffered** for this motherboard. To determine the DIMM type, check the notches on the DIMMs (see figure below).

### 168-Pin DIMM Notch Key Definitions (3.3V)

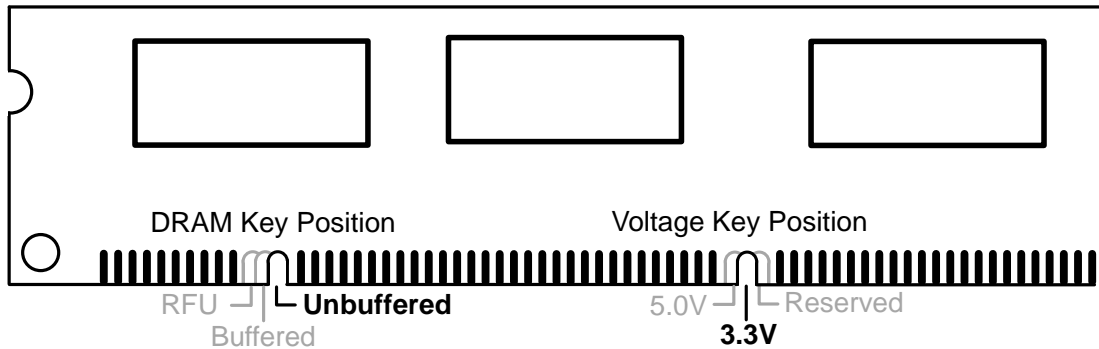

The notches on the DIMM module will shift between left, center, or right to identify the type and also to prevent the wrong type from being inserted into the DIMM slot on the motherboard. You must ask your retailer the correct DIMM type before purchasing. This motherboard supports four clock signals.

**3. HW SETUP**  
System Memory

# 3. HARDWARE SETUP

---

(This page was intentionally left blank.)



## 3. HARDWARE SETUP

### 3.6 Central Processing Unit (CPU)

**NOTE:** The following pictures are provided for reference purposes only. The appearance of your retention mechanism and fan may be different from the following examples.

Your motherboard provides a Slot A connector for an AMD Athlon™ processor.

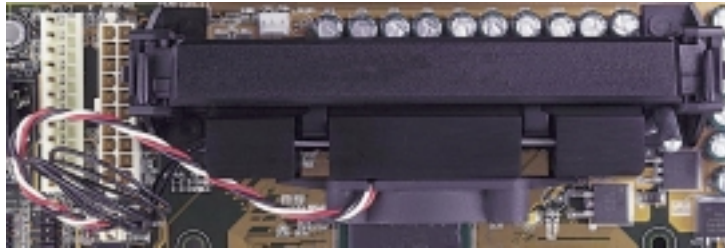

AMD Athlon™ processor with heatsink and fan (top view)

#### 3.6.1 Universal Retention Mechanism

Your motherboard comes preinstalled with a Universal Retention Mechanism (URM). The URM supports the AMD Athlon™ processor.

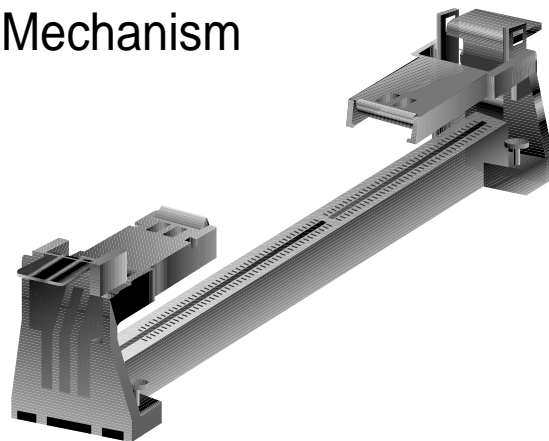

Universal Retention Mechanism (URM)

#### 3.6.2 Heatsinks

The recommended heatsinks (see section on recommended heatsinks for AMD Athlon™ processors for more information) for the processors are those with three-pin fans that can be connected to the fan connectors on the motherboard.

**WARNING!** Be sure that there is sufficient air circulation across the processor's heatsink by regularly checking that your CPU fan is working. Without sufficient circulation, the processor could overheat and damage both the processor and the motherboard. At least one fan, aside from the processor cooling fan, must be installed in the back of the system case, drawing air over the processor, and exhausting the air out the back of the case.

# 3. HARDWARE SETUP

## 3.6.3 Installing the Processor

1. **Unlock the URM's Folding Support Arms:**  
The folding support arms of the URM are locked when shipped.

To unlock the support arms, simply flip them up to an upright position.

The URM is now ready for the installation of your processor.

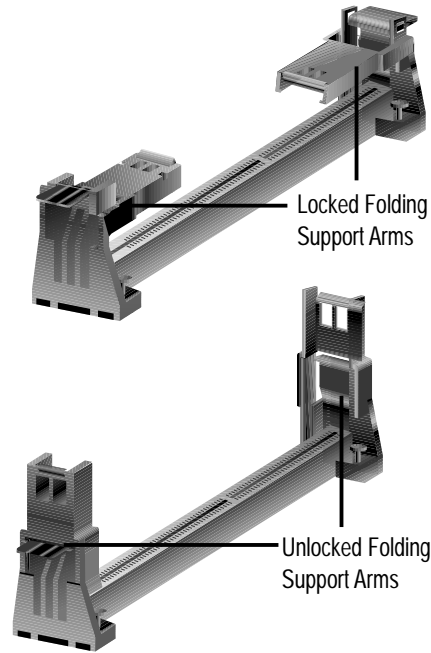

2. **Attach the Heatsink**

**NOTE:** If provided, you should follow the heatsink attachment instructions that came with your heatsink or processor. The following steps are provided only as a general guide and may not reflect those for your heatsink.

### Using the cartridge fan

Push the two lock arms one direction to clamp the heatsink onto the processor and the other direction to release.

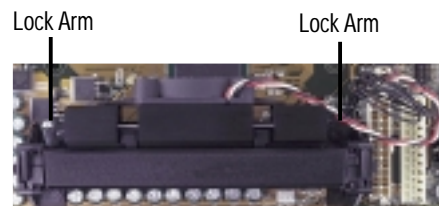

**WARNING!** Make sure the heatsink is mounted tightly against the cartridge; otherwise, the CPU will overheat. Make sure you install an auxiliary fan to provide adequate circulation across the processor's passive heatsink.

# 3. HARDWARE SETUP

## 3. Insert the cartridge

Push the cartridge's two locks inward until you hear a click (the picture in step 2 shows the locks in the outward position and inward in the picture below).

With the heatsink facing the motherboard's chipset, push the cartridge gently but firmly into the Slot A connector until it is fully inserted.

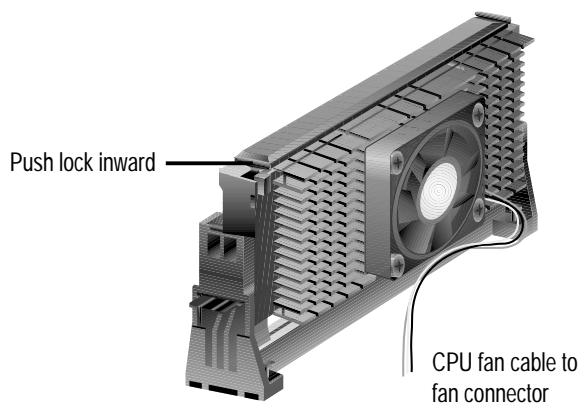

## 4. Secure the cartridge

Secure the cartridge in place by pushing the cartridge until it is firmly seated on the Slot A connector.

The SECC locks should be outward when secured so that the lock shows through the retention mechanism's lock holes.

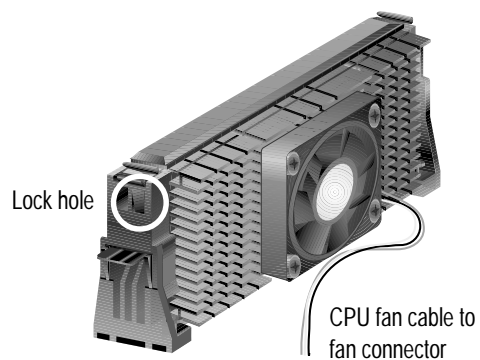

# 3. HARDWARE SETUP

## 3.6.4 Smart Thermal Solutions

Two smart solutions to Slot A CPU thermal problems are available from ASUSTeK COMPUTER INC.: the **ASUS Smart Fan** or **ASUS S-K7FAN** and the **ASUS P2T-Cable**.

### ASUS S-K7FAN

The optional ASUS Smart Fan or ASUS S-K7FAN is a CPU fan for a processor packaged in a Single Edge Contact Cartridge (SECC). Unlike other CPU thermal solutions, the ASUS S-K7FAN has an integrated thermal sensor located near the center of the CPU heat source. The sensor is optimized to give the most accurate reading of the CPU temperature, thus provides the best protection to your computer system.

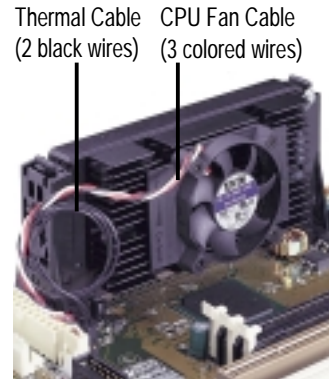

### To Use the ASUS S-K7FAN

See **2. Attach the Heatsink** on the preceding page for the relevant procedures. Note that the S-K7FAN comes with a rock arm design for easy FAN/CPU installation.

### ASUS P2T-Cable

The optional ASUS P2T-Cable can be used for a processor packaged in an SECC2/SECC/SEPP.

**NOTE:** The ASUS P2T-Cable can only be used in a Slot A motherboard with a 2-pin thermal sensor connector.

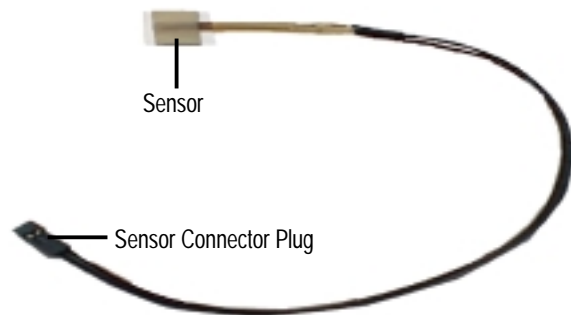

### To Use the ASUS P2T-Cable

**NOTE:** The following procedures assume that you have properly attached a heatsink onto an SECC2/SECC/SEPP.

1. Simply peel off the tab from the sensor and then stick the sensor near the middle edge of the boxed processor heatsink with fan, as indicated.



# 3. HARDWARE SETUP

**WARNING!** Do not insert the sensor between the processor and heatsink, otherwise, it will cause damage to the P2T-Cable.

**IMPORTANT!** Accurate readings are guaranteed only for the ASUS Smart Fan.

2. Connect the P2T-Cable to the CPU thermal sensor connector (TRCPU).

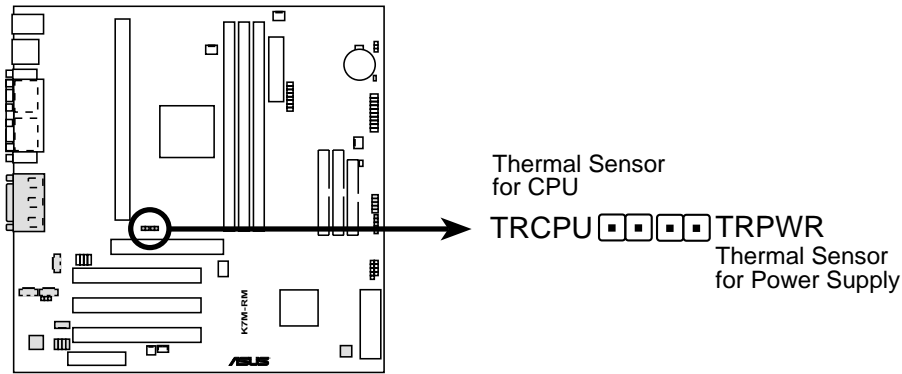

**K7M-RM Thermal Sensor Connectors**

**NOTE:** If you have a power supply with thermal monitoring, connect its thermal sensor cable to TRPWR.

## 3.6.5 Recommended Heatsinks for Slot A Processors

The recommended heatsinks for the Slot A processors are those with three-pin fans, such as the ASUS Smart Fan, that can be connected to the motherboard's CPU fan connector. These heatsinks dissipate heat more efficiently and with an optional hardware monitor, they can monitor the fan's RPM and use the alert function with the Intel LANDesk Client Manager (LDCM) or the ASUS PC Probe software.



**SECC Heatsink & Fan**

# 3. HARDWARE SETUP

---

(This page was intentionally left blank.)

# 3. HARDWARE SETUP

---

## 3.7 Expansion Cards

**WARNING!** Unplug your power supply when adding or removing expansion cards or other system components. Failure to do so may cause severe damage to both your motherboard and expansion cards.

### 3.7.1 Expansion Card Installation Procedure

1. Read the documentation for your expansion card and make any necessary hardware or software settings for your expansion card, such as jumpers.
2. Remove your computer system's cover and the bracket plate on the slot you intend to use. Keep the bracket for possible future use.
3. Carefully align the card's connectors and press firmly.
4. Secure the card on the slot with the screw you removed above.
5. Replace the computer system's cover.
6. Set up the BIOS if necessary  
(such as *IRQ xx Used By ISA: Yes* in PNP AND PCI SETUP)
7. Install the necessary software drivers for your expansion card.

### 3.7.2 Assigning IRQs for Expansion Cards

Some expansion cards need an IRQ to operate. Generally, an IRQ must be exclusively assigned to one use. In a standard design, there are 16 IRQs available but most of them are already in use, leaving 6 IRQs free for expansion cards. If your motherboard has **PCI** audio onboard, an additional IRQ will be used. If your motherboard also has **MIDI** enabled, another IRQ will be used, leaving 4 IRQs free.

## 3. HARDWARE SETUP

The following table lists the default IRQ assignments for standard PC devices. Use this table when configuring your system and for resolving IRQ conflicts.

### *Standard Interrupt Assignments*

IRQ	Priority	Standard Function
0	1	System Timer
1	2	Keyboard Controller
2	N/A	Programmable Interrupt
3*	11	Communications Port (COM2)
4*	12	Communications Port (COM1)
5*	13	
6	14	Floppy Disk Controller
7*	15	Printer Port (LPT1)
8	3	System CMOS/Real Time Clock
9*	4	ACPI Mode when enabled
10*	5	IRQ Holder for PCI Steering
11*	6	IRQ Holder for PCI Steering
12*	7	PS/2 Compatible Mouse Port
13	8	Numeric Data Processor
14*	9	Primary IDE Channel
15*	10	Secondary IDE Channel

\*These IRQs are usually available for ISA or PCI devices.

### *Interrupt Request Table for this Motherboard*

Interrupt requests are shared as shown by the following table:

	INT-A	INT-B	INT-C	INT-D
PCI slot 1	shared	—	—	—
PCI slot 2	—	not shared	—	—
PCI slot 3	—	—	—	shared
AGP slot	shared	—	—	—
Onboard USB controller	—	—	—	shared
Onboard AC'97/MC'97 codec/AMR	—	—	not shared	—

**IMPORTANT:** If using PCI cards on shared slots, make sure that the drivers support “Share IRQ” or that the cards do not need IRQ assignments. Conflicts will arise between the two PCI groups that will make the system unstable or cards inoperable.



# 3. HARDWARE SETUP

## 3.7.3 Accelerated Graphics Port (AGP)

This motherboard provides an Accelerated Graphics Port (AGP) slot to support a new generation of graphics cards with ultra-high memory bandwidth, such as an ASUS 3D graphics accelerator.

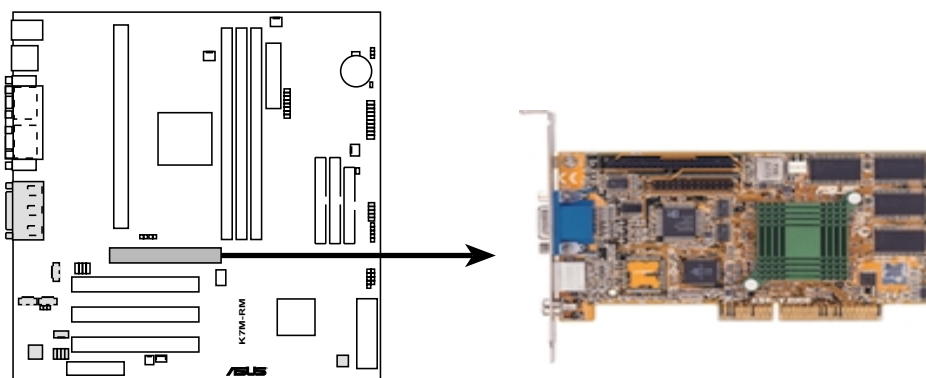

**K7M-RM Accelerated Graphics Port (AGP)**

## 3.7.4 Audio Modem Riser (AMR) Slot

This connector supports a specially designed audio and/or modem card called an AMR. Main processing is done through software and controlled by the motherboard's system chipset. This provides an upgradeable audio and/or modem solution at an incredibly low cost. There are two types of AMR, one defined as primary and another defined as secondary. This motherboard uses the primary channel so that a secondary AMR can coexist without the need to disable the onboard CODEC. The motherboard's onboard CODEC must be disabled when using a primary AMR.

**IMPORTANT:** The AMR slot of this motherboard shares the same expansion slot as PCI Slot 3. Because of this and its location, the slot can only accept a specially designed AMR card (optional). While a standard AMR card's bracket is to the left of the card (facing the expansion slot), the specially-designed AMR card's bracket is to the right of the card. For availability, see your vendor or dealer.

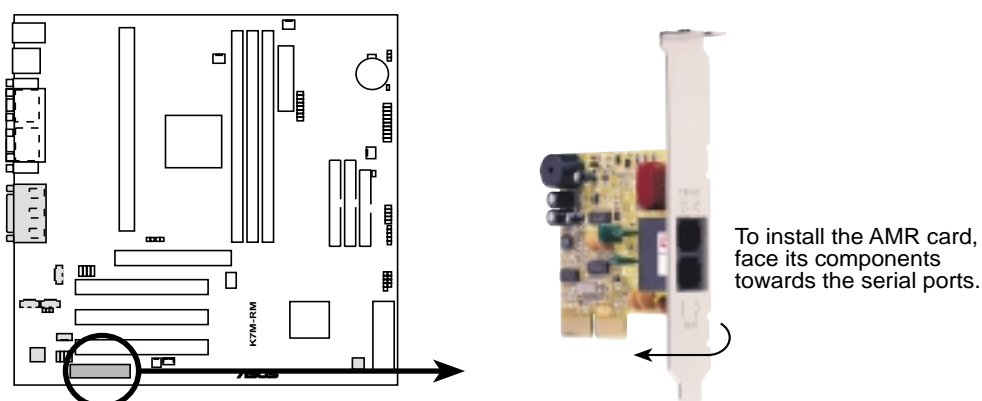

**K7M-RM Audio Modem Riser (AMR) Slot**

# 3. HARDWARE SETUP

## 3.8 External Connectors

**WARNING!** Some pins are used for connectors or power sources. These are clearly distinguished from jumpers in the Motherboard Layout. Placing jumper caps over these connector pins will cause damage to your motherboard.

**IMPORTANT:** Ribbon cables should always be connected with the red stripe to Pin 1 on the connectors. Pin 1 is usually on the side closest to the power connector on hard drives and CD-ROM drives, but may be on the opposite side on floppy disk drives. Check the connectors before installation because there may be exceptions. IDE ribbon cable must be less than 46 cm (18 in.), with the second drive connector no more than 15 cm (6 in.) from the first connector.

### 1) PS/2 Mouse Connector (Green 6-pin PS2KBMS)

The system will direct IRQ12 to the PS/2 mouse if one is detected. If one is not detected, expansion cards can use IRQ12. See **PS/2 Mouse Function Control** in *4.4 Advanced Menu*.

PS/2 Mouse (6-pin Female)

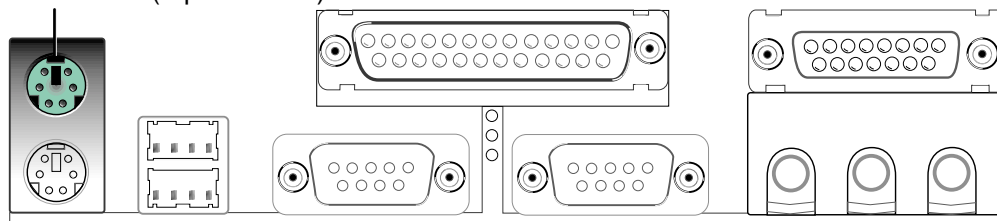

### 2) PS/2 Keyboard Connector (Purple 6-pin PS2KBMS)

This connection is for a standard keyboard using an PS/2 plug (mini DIN). **This connector will not allow standard AT size (large DIN) keyboard plugs. You may use a DIN to mini DIN adapter on standard AT keyboards.**

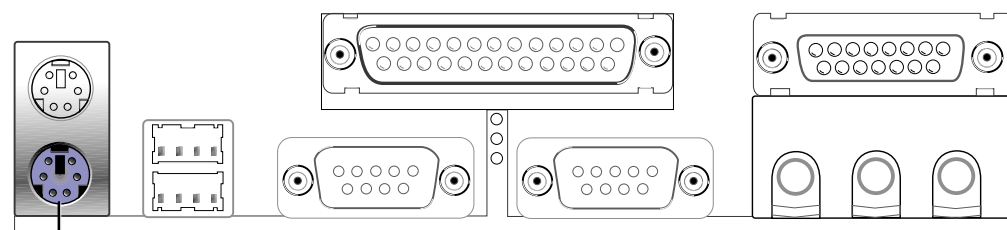

PS/2 Keyboard (6-pin Female)

# 3. HARDWARE SETUP

## 3) Universal Serial BUS Ports 0 & 1 (Black two 4-pin USB)

Two USB ports are available for connecting USB devices.

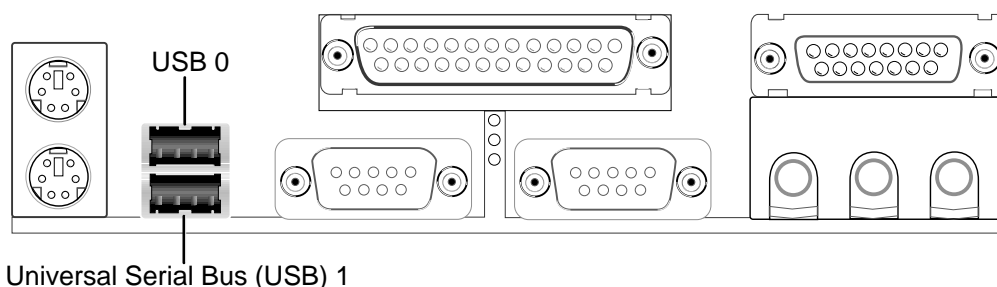

## 4) Parallel Port Connector (Burgundy 25-pin PRINTER)

You can enable the parallel port and choose the IRQ through **Onboard Parallel Port** (see **4.4.2 I/O Device Configuration**).

**NOTE:** Serial printers must be connected to the serial port.

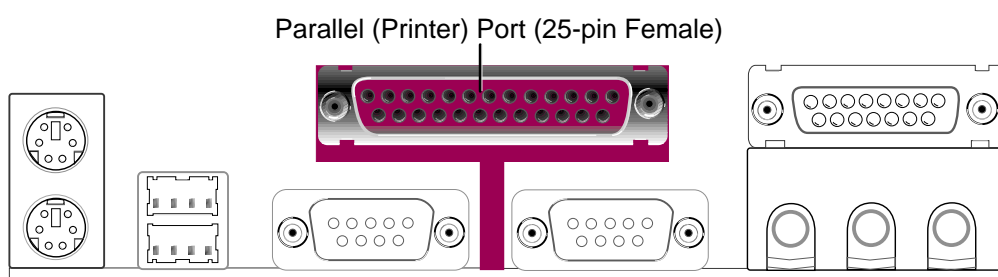

## 5) Serial Port Connectors (Teal/Turquoise 9-pin COM1/COM2)

One serial port is ready for a mouse or other serial devices. A second serial port is available using a serial port bracket connected from the motherboard to an expansion slot opening. See **Onboard Serial Port 1** in **4.2.2 I/O Device Configuration** for settings.

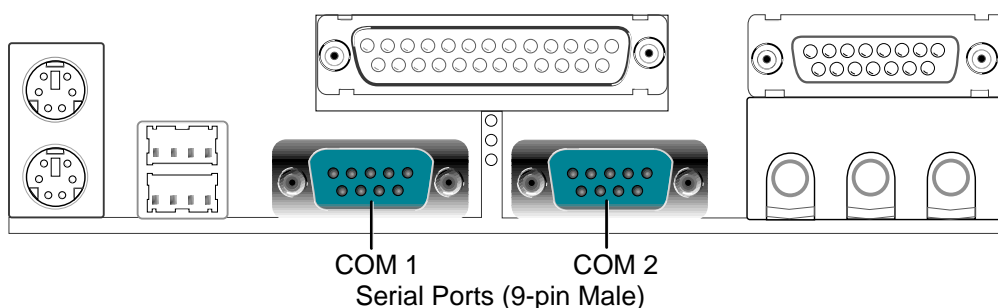

## 3. HARDWARE SETUP

### 6) Joystick/MIDI Connector (Gold 15-pin GAME\_AUDIO) (optional)

You may connect game joysticks or game pads to this connector for playing games. Connect MIDI devices for playing or editing professional audio.

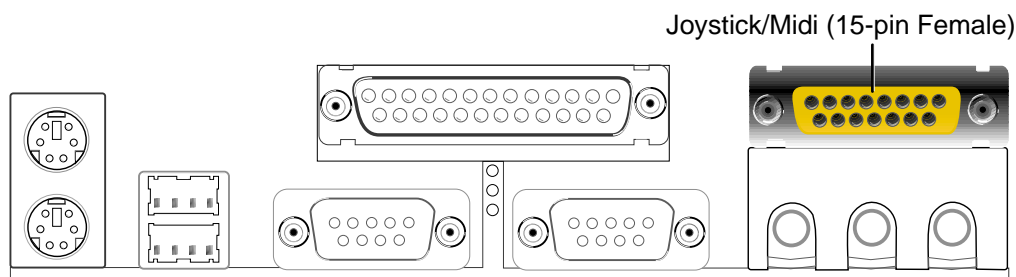

### 7) Audio Port Connectors (Three 1/8" GAME\_AUDIO) (optional)

**Line Out** (lime) can be connected to headphones or preferably powered speakers. **Line In** (light blue) allows tape players or other audio sources to be recorded by your computer or played through the **Line Out** (lime). **Mic** (pink) allows microphones to be connected for inputting voice.

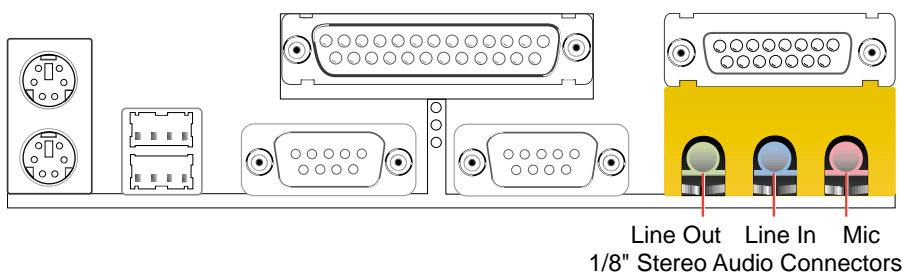

# 3. HARDWARE SETUP

## 8) Primary (Blue) / Secondary IDE Connectors (Two 40-1pin IDE)

These connectors support the provided UltraDMA/66 IDE hard disk ribbon cable. Connect the cable's blue connector to the motherboard's primary (recommended) or secondary IDE connector, and then connect the gray connector to your UltraDMA/66 slave device (hard disk drive) and the black connector to your UltraDMA/66 master device. It is recommended that non-UltraDMA/66 devices be connected to the secondary IDE connector. If you install two hard disks, you must configure the second drive to Slave mode by setting its jumper accordingly. Please refer to your hard disk documentation for the jumper settings. BIOS now supports specific device bootup (see **4.4.1 Advanced CMOS Setup**). **(Pin 20 is removed to prevent inserting in the wrong orientation when using ribbon cables with pin 20 plugged).**

**TIP:** You may configure two hard disks to be both Masters with two ribbon cables – one for the primary IDE connector and another for the secondary IDE connector. You may install one operating system on an IDE drive and another on a SCSI drive and select the boot disk through **4.4.1 Advanced CMOS Setup**.

**IMPORTANT:** UltraDMA/66 IDE devices must use a 40-pin 80-conductor IDE cable for 66MBytes/s transfer rates.

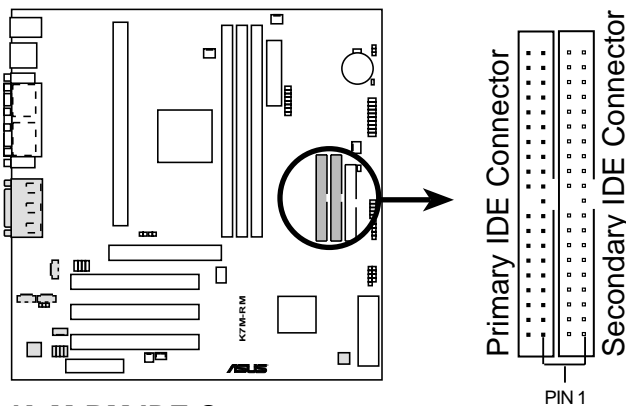

**K7M-RM IDE Connectors**

**NOTE:** Orient the red markings (usually zigzag) on the IDE ribbon cable to PIN 1.

## 9) Floppy Disk Drive Connector (34-1pin FLOPPY)

This connector supports the provided floppy drive ribbon cable. After connecting the single end to the board, connect the two plugs on the other end to the floppy drives. **(Pin 5 is removed to prevent inserting in the wrong orientation when using ribbon cables with pin 5 plugged).**

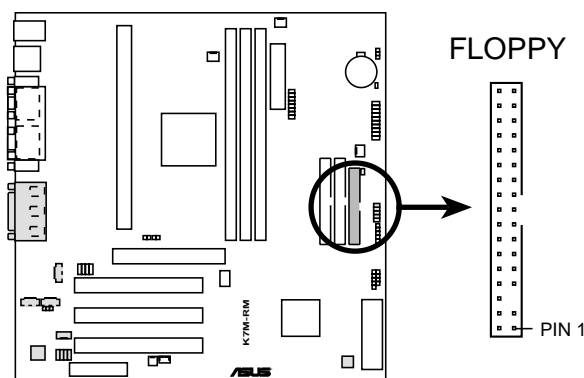

**K7M-RM Floppy Disk Drive Connector**

**NOTE:** Orient the red markings on the floppy ribbon cable to PIN 1.

# 3. HARDWARE SETUP

## 10) Wake-On-LAN Connector (3-pin WOL\_CON)

This connector connects to a LAN card with a Wake-On-LAN output, such as the ASUS PCI-L101 Ethernet card (see 7. *Appendix*). The connector powers up the system when a wakeup packet or signal is received through the LAN card.

**IMPORTANT:** This feature requires that **Wake-On-Lan** features are enabled (see 4.4.3 *Power Management*) and that your system has an ATX power supply with at least 720mA +5V standby power.

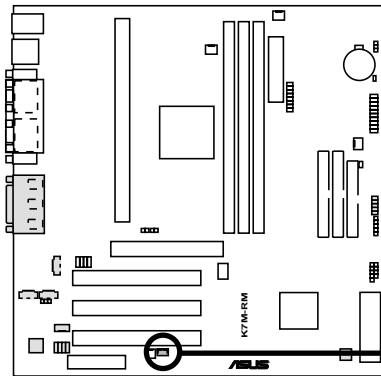

**IMPORTANT:** Requires an ATX power supply with at least 720mA +5 volt standby power

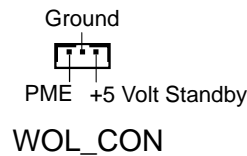

K7M-RM Wake-On-LAN Connector

## 11) Wake-On-Ring Connector (2-pin WOR)

This connector connects to internal modem cards with a Wake-On-Ring output. The connector powers up the system when a ringup packet or signal is received through the internal modem card. **NOTE:** For external modems, Wake-On-Ring is detected through the COM port.

**IMPORTANT:** This feature requires that **Wake-On-Ring** features are enabled (see 4.4.3 *Power Management*) and that your system has an ATX power supply with at least 720mA +5V standby power.

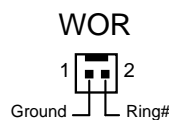
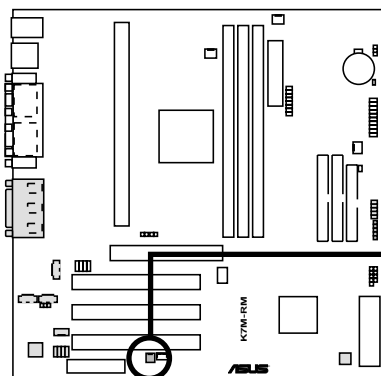

K7M-RM Wake-On-Ring Connector

# 3. HARDWARE SETUP

## 12) IDE Activity LED (2-pin IDE)

This connector supplies power to the cabinet's IDE activity LED. Read and write activity by devices connected to the Primary or Secondary IDE connectors will cause the LED to light up.

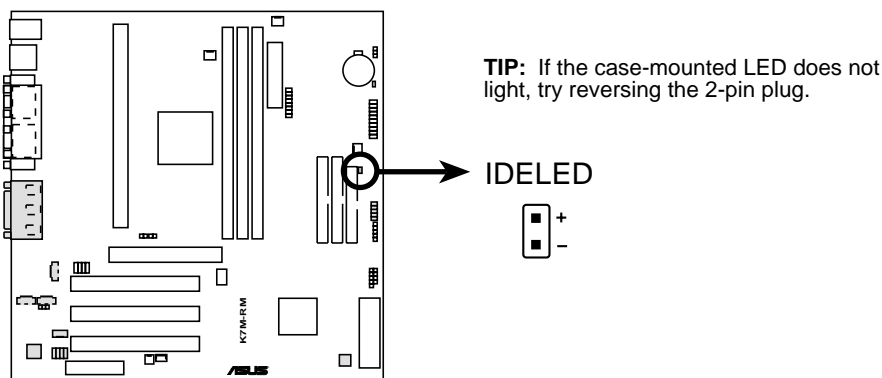

**K7M-RM IDE Activity LED**

## 13) Power Supply, CPU, Chassis Fan Connectors (3-pin PWR\_FAN, CPU\_, CHA\_FAN)

These connectors support cooling fans of 350mA (4.2 Watts) or less. Orientate the fans so that the heat sink fins allow airflow to go across the onboard heat sink(s) instead of the expansion slots. Depending on the fan manufacturer, the wiring and plug may be different. The red wire should be positive, while the black should be ground. Connect the fan's plug to the board taking into consideration the polarity of the connector.

**NOTE:** The "Rotation" signal is to be used only by a specially designed fan with rotation signal. The Rotations per Minute (RPM) can be monitored using ASUS PC Probe (see section 6. SOFTWARE REFERENCE) or Intel LDCM Utility.

**WARNING!** The CPU and/or motherboard will overheat if there is no airflow across the CPU and onboard heatsinks. Damage may occur to the motherboard and/or the CPU fan if these pins are incorrectly used. **These are not jumpers, do not place jumper caps over these pins.**

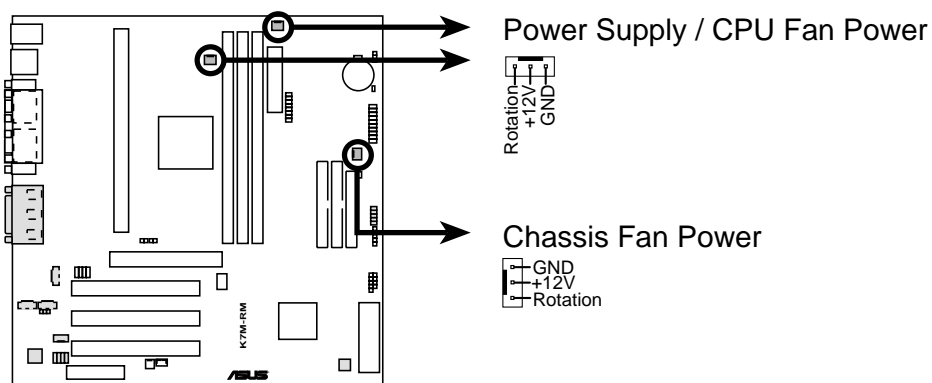

**K7M-RM 12-Volt Cooling Fan Power**

# 3. HARDWARE SETUP

## 14) Internal Audio Connectors (4-pin CD, AUX, VIDEO, MODEM)

These connectors allow you to receive stereo audio input from such sound sources as a CD-ROM, TV tuner, or MPEG card. The MODEM connector allows the onboard audio to interface with a voice modem card with a similar connector. It also allows the sharing of mono\_in (such as a phone) and mono\_out (such as a speaker) between the onboard audio and a voice modem card.

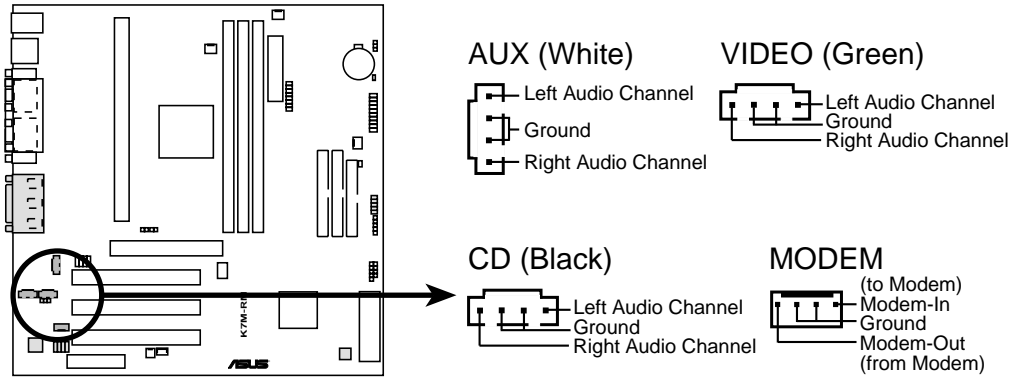

**K7M-RM Internal Audio Connectors**

## 15) Headphone True-Level Line Out Header (3 pin HPHONE) (optional)

This connector allows you to connect a chassis mounted headphone to the motherboard instead of having to attach an external headphone onto the ATX connectors.

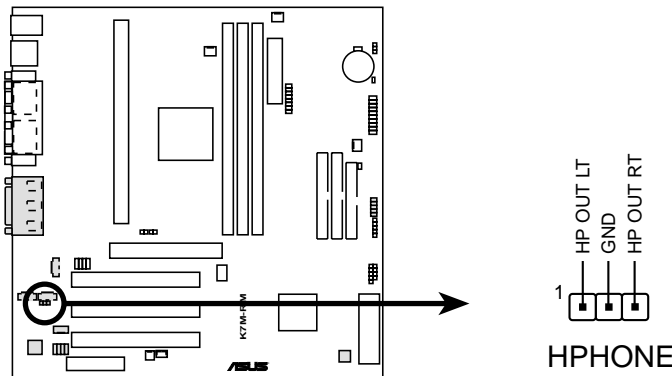

**K7M-RM True-Level Line Out Header**



# 3. HARDWARE SETUP

## 16) Serial Infrared Module Connector (5-pin IR)

This connector supports an optional wireless transmitting and receiving infrared module. This module mounts to a small opening on system cases that support this feature. You must also configure the setting through **4.4.5 Peripheral Setup** to select whether UART2 is directed for use with COM2 or IrDA. Use the five pins as shown in Back View and connect a ribbon cable from the module to the motherboard's IR connector according to the pin definitions.

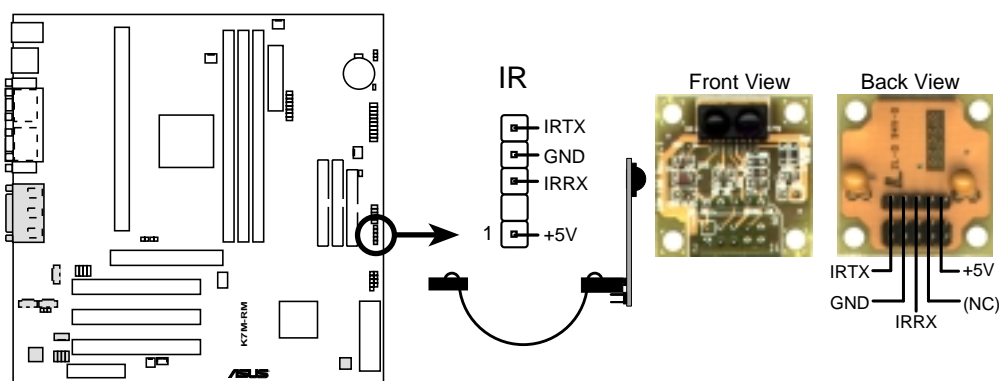

**K7M-RM Infrared Module Connector**

## 17) SMBus Connector (5-1 pin SMB)

This connector allows you to connect SMBus (System Management Bus) devices. SMBus devices communicate by means of the SMBus with an SMBus host and/or other SMBus devices. SMBus is a specific implementation of an I<sup>2</sup>C bus, which is a multi-device bus; that is, multiple chips can be connected to the same bus and each one can act as a master by initiating data transfer.

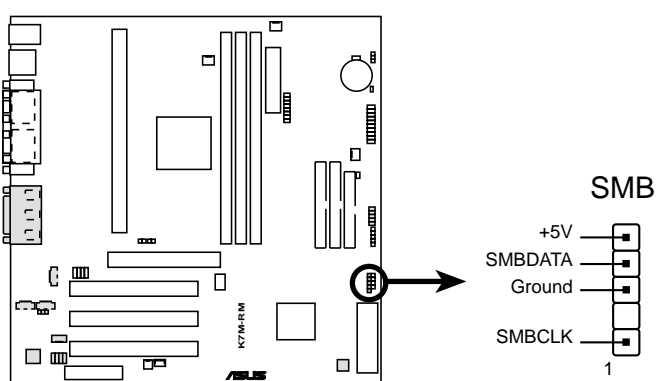

**K7M-RM SMBus Connector**

# 3. HARDWARE SETUP

## 18) Chassis Intrusion Lead (4-1 pin CHASSIS)

This lead is for a chassis designed for chassis intrusion detection. After-market toggle switches may also be installed to the chassis panel or on any removable components. Two wires should be available from the chassis to connect to this lead. When any chassis component is removed, the contact should open and the motherboard will record a chassis intrusion event. The event can then be processed by software, such as LDCM. If the chassis intrusion lead is not used, a jumper cap must be placed over the pins to prevent unnecessary power loss.

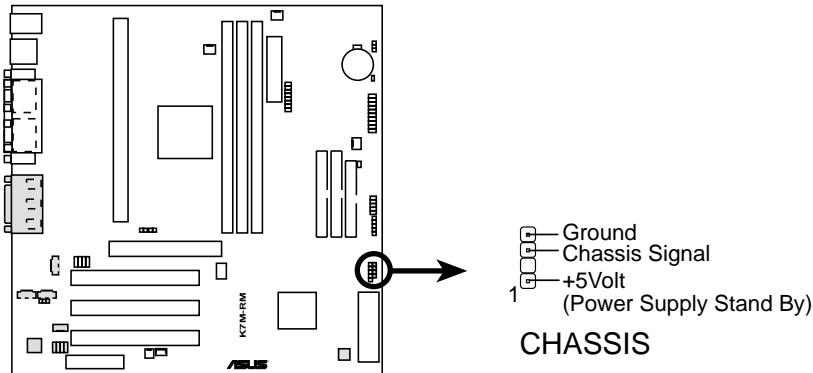

**K7M-RM Chassis Open Alarm Lead**

## 19) ATX Power Supply Connector (20-pin block ATXPWR)

This connector connects to an ATX power supply. The plug from the power supply will only insert in one orientation because of the different hole sizes. Find the proper orientation and push down firmly making sure that the pins are aligned.

**IMPORTANT:** Make sure that your ATX power supply (minimum recommended wattage: 200 watts; 235W for a fully-configured system) can supply at least 20 amperes on the +5-volt lead and 10mA on the +5-volt standby lead (+5VSB). Your system may become unstable/unreliable and may experience difficulty in powering up if your power supply is inadequate. For Wake-On-LAN support, your ATX power supply must supply at least 720mA +5VSB.

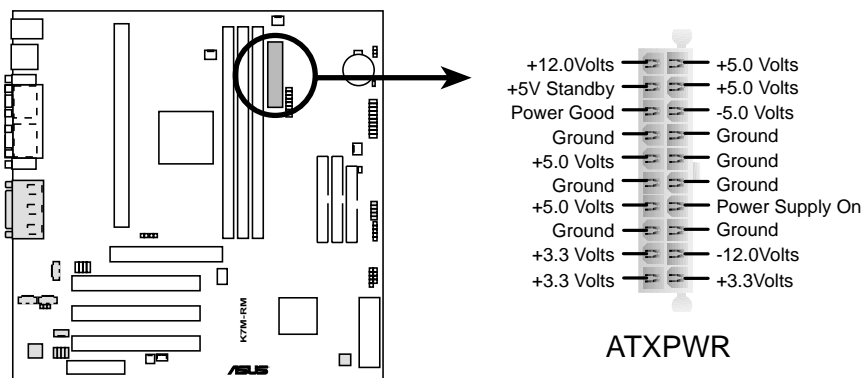

**K7M-RM ATX Power Connector**

# 3. HARDWARE SETUP

## 20) USB Connector Set (10-1 pin USBPORT)

If the USB Ports on the back panels are inadequate, a USB connector set is available midboard. If you want to use this connector, you need to use the bundled external connector set. The external connector set connects to the 10-1 pin block and mounts to an open slot on your computer's chassis.

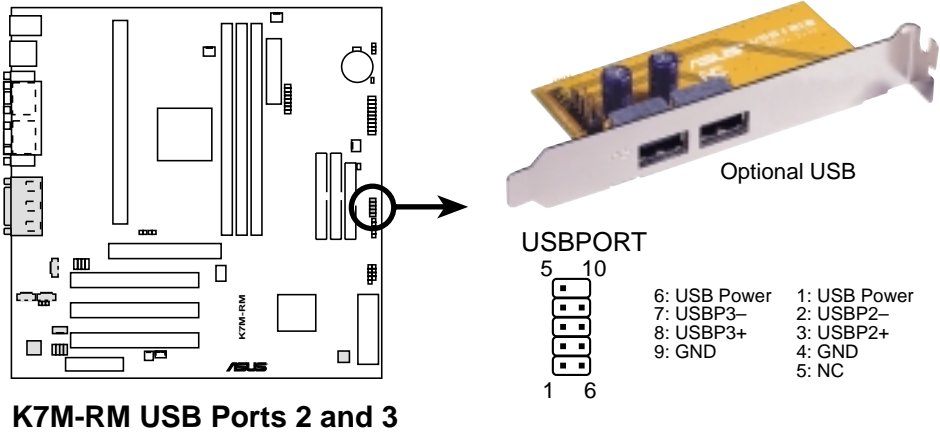

The following PANEL illustration is used for items 21-25 (next page).

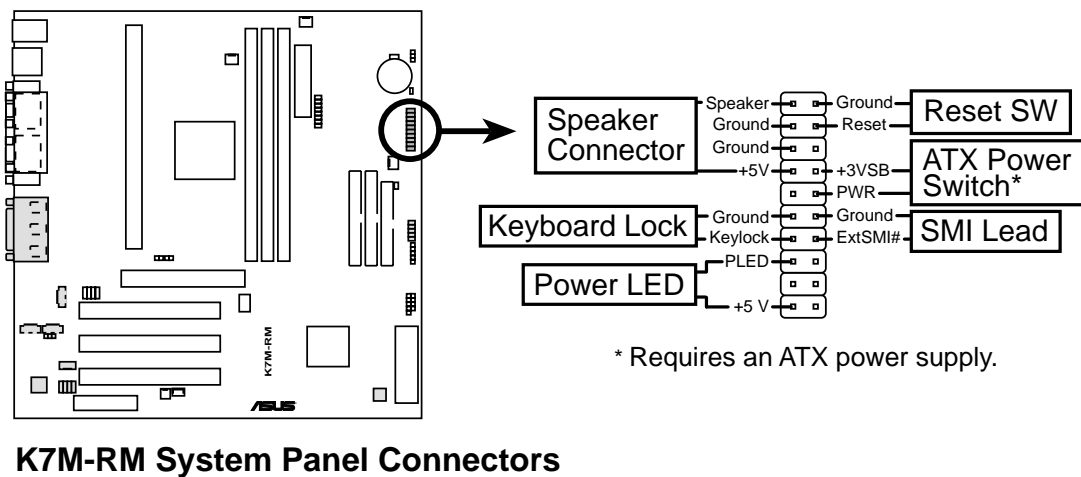

## 3. HARDWARE SETUP

---

### 21) System Warning Speaker Connector (4-pin SPEAKER)

This 4-pin connector connects to the case-mounted speaker. Two sources (LINE\_OUT and SPEAKER) will allow you to hear system beeps and warnings. Only SPEAKER will allow you to hear system beeps before the integrated audio has been properly initialized.

### 22) System Power LED Lead (3-1 pin PWRLED)

This 3-1 pin connector connects the system power LED, which lights when the system is powered on and blinks when it is in sleep mode.

### 23) Reset Switch Lead (2-pin RESET)

This 2-pin connector connects to the case-mounted reset switch for rebooting your computer without having to turn off your power switch. This is a preferred method of rebooting to prolong the life of the system's power supply.

### 24) ATX Power Switch Lead (2-pin PWRSW)

The system power is controlled by a momentary switch connected to this lead. Pressing the button once will switch the system between ON and SOFT OFF. Pushing the switch while in the ON mode for more than 4 seconds will turn the system off. The system power LED shows the status of the system's power.

### 25) System Management Interrupt Lead (2-pin SMI)

This allows the user to manually place the system into a suspend mode or "Green" mode, where system activity is decreased to save electricity and expand the life of certain components when the system is not in use. This 2-pin connector connects to the case-mounted suspend switch. If you do not have a switch for the connector, you may use the "Turbo Switch." SMI is activated when it detects a *short to open* moment and therefore leaving it shorted will not cause any problems. This may require one or two presses depending on the position of the switch. Wake-up can be controlled by settings in the BIOS but the keyboard will always allow wake-up (the SMI lead cannot wake up the system).

# 3. HARDWARE SETUP

---

## 3.9 Power Connection Procedures

1. After all jumpers and connections are made, close the system case cover.
  2. Be sure that all switches are off (in some systems, marked with ○).
  3. Connect the power supply cord into the power supply located on the back of your system case according to your system user's manual.
  4. Connect the power cord into a power outlet that is equipped with a surge protector.
  5. You may then turn on your devices in the following order:
    - a. Your monitor
    - b. External SCSI devices (starting with the last device on the chain)
    - c. Your system power.

For ATX power supplies, you need to switch ON the power supply if a switch is provided as well as press the ATX power switch on the front of the case.
  6. The power LED on the front panel of the system case will light. For ATX power supplies, the system LED will light when the ATX power switch is pressed. The monitor LED may light up after the system's if it complies with "green" standards or if it has a power standby feature. The system will then run power-on tests. While the tests are running, additional messages will appear on the screen. If you do not see anything within 30 seconds from the time you turn on the power, the system may have failed a power-on test. Recheck your jumper settings and connections or call your retailer for assistance.
  7. During power-on, hold down <Delete> to enter BIOS Setup. Follow the instructions in **4. BIOS SETUP**.
- \* **Powering Off your computer:** You must first exit or shut down your operating system before switching off the power switch. For ATX power supplies, you can press the ATX power switch after exiting or shutting down your operating system. If you use Windows 95/98, click the **Start** button, click **Shut Down**, and then click **Shut down the computer?**. The power supply should turn off after Windows shuts down.

**NOTE:** The message "You can now safely turn off your computer" will not appear when shutting down with ATX power supplies.

# 4. BIOS SETUP

## 4.1 Managing and Updating Your BIOS

### 4.1.1 Upon First Use of the Computer System

It is recommended that you save a copy of the original motherboard BIOS along with a Flash EPROM Programming Utility (FLASHXXX.EXE) to a bootable floppy disk in case you need to reinstall the BIOS later. **FLASHXXX.EXE** is a Flash EPROM Programming Utility that updates the BIOS by uploading a new BIOS file to the programmable flash ROM on the motherboard. This file works only in DOS mode. To determine the BIOS version of your motherboard, check the release date displayed on the top of your screen during bootup. Newer dates represent a newer BIOS file.

**IMPORTANT:** The **XXX** in **FLASHXXX.EXE** are actually 3 numbers that represent the version of this utility.

1. Type **FORMAT A:/S** at the DOS prompt to create a bootable system floppy disk. **DO NOT** copy AUTOEXEC.BAT and CONFIG.SYS to the disk.
2. Type **COPY D:\FLASH\FLASHXXX.EXE A:\** (assuming D is your CD-ROM drive) to copy FLASHXXX.EXE to the just created boot disk.  
**NOTE:** FLASH works only in DOS mode. It will not work with DOS prompt in Windows and will not work with certain memory drivers that may be loaded when you boot from your hard drive. It is recommended that you reboot using a floppy disk.
3. Reboot your computer from the floppy disk. **NOTE:** BIOS Setup must specify “Floppy” as the first item in the boot sequence.
4. In DOS mode, type **A:\FLASHXXX** and then press <Enter> to run FLASH.

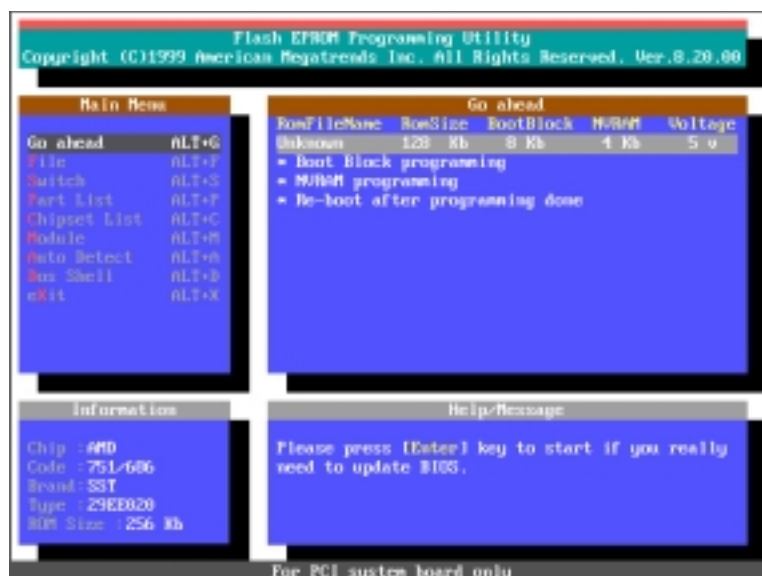

## 4. BIOS SETUP

- Use the up or down keypad arrow to select **File** from the Main Menu and press <Enter> to activate the **File** frame.

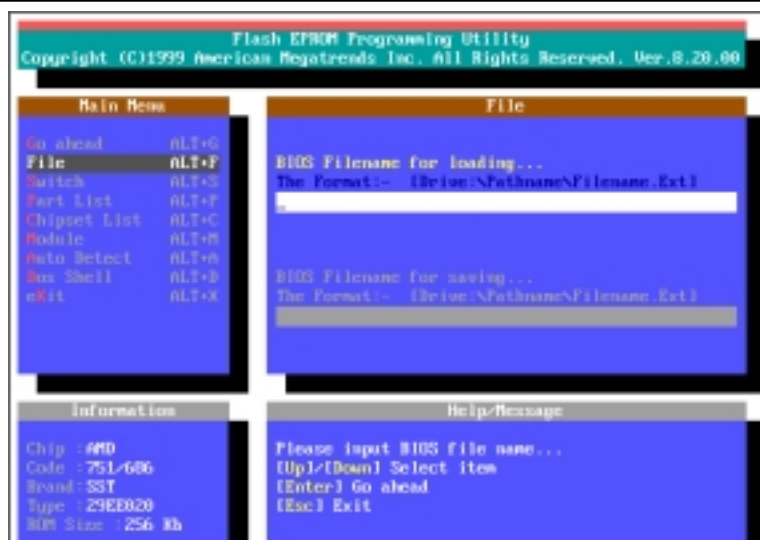

- Use the up or down keypad arrow to select the **BIOS Filename for saving** field. Type a filename and the path, for example, **A:\XXXXXXXXXX** and then press <Enter>.

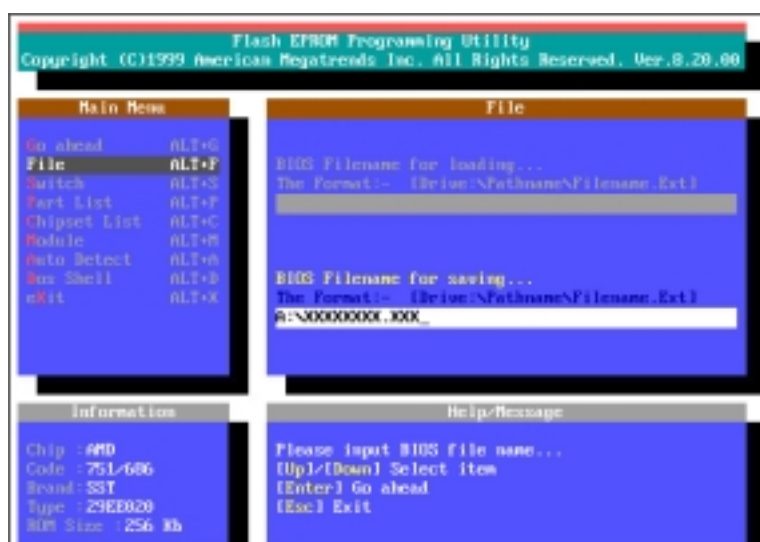

- When the saving is finished, "**BIOS ROM data saving successful.**" will be displayed.

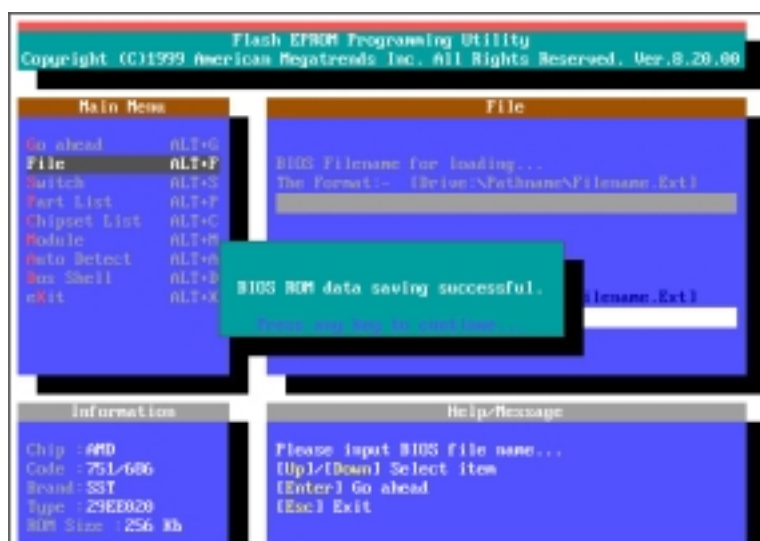

4. BIOS SETUP  
Updating BIOS



# 4. BIOS SETUP

## 4.1.2 Updating BIOS Procedures

**WARNING!** Only update if you have problems with your motherboard and you know that the new BIOS file will solve these problems. Careless updating can result in your motherboard having more problems!

1. Download or get an updated BIOS (see **ASUS CONTACT INFORMATION** on page 3 for details) and save to the disk you created earlier.
2. Boot from the disk you created earlier.
3. In DOS mode, type **A:\FLASHXXX <Enter>** to run FLASH.
4. Follow step **5** in **4.1.1 Upon First Use of the Computer System**.

5. Use the up or down keypad arrow to select the **BIOS Filename for loading** field. Type the filename of your new BIOS and the path, for example, **A:\XXXXXXXXXX** and then press <Enter>. When prompted to confirm the BIOS flash, press <Enter>.

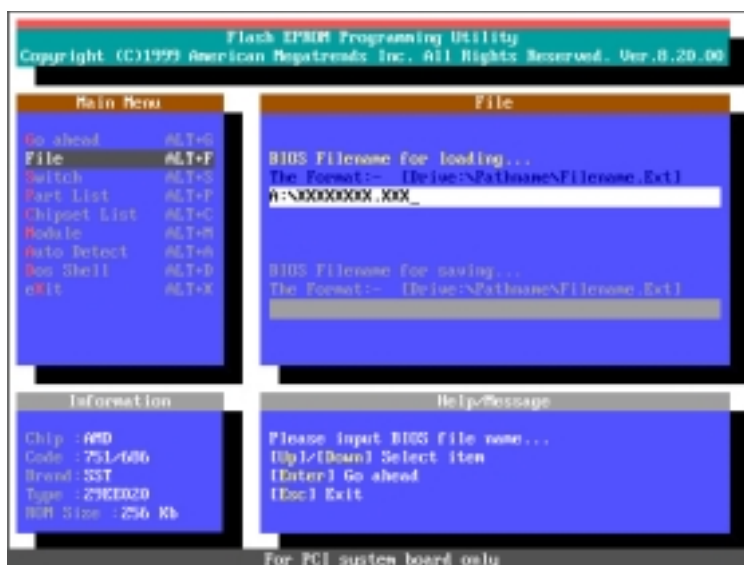

6. When the saving is finished, "*Flash ROM Update Completed - Pass.*" will be displayed.

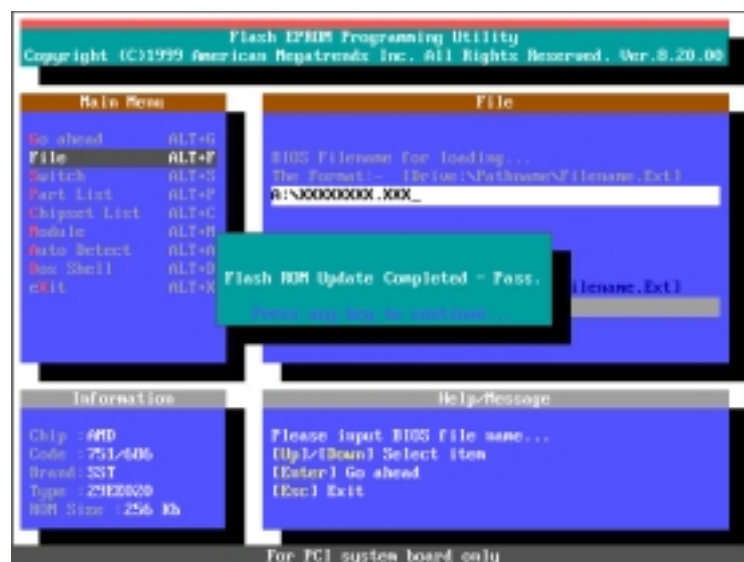

7. Follow the onscreen instructions to exit the Flash EPROM Programming Utility. The system will automatically reboot.

**WARNING!** If you encounter problems while updating the new BIOS, DO NOT turn off your system since this might prevent your system from booting up. Just repeat the process, and if the problem still persists, update the original BIOS file you saved to disk above. If the Flash EPROM Programming Utility was not able to successfully update a complete BIOS file, your system may not be able to boot up. If this happens, your system will need servicing.



# 4. BIOS SETUP

---

## 4.2 BIOS Setup Program

This motherboard supports a programmable EEPROM that can be updated using the provided utility as described in *4.1 Managing and Updating Your BIOS*.

The utility is used if you are installing a motherboard, reconfiguring your system, or prompted to “**Run Setup**”. This section describes how to configure your system using this utility.

Even if you are not prompted to use the Setup program, at some time in the future you may want to change the configuration of your computer. For example, you may want to enable the Supervisor Password Feature or make changes to the power management settings. It will then be necessary to reconfigure your system using the BIOS Setup program so that the computer can recognize these changes and record them in the CMOS RAM of the EEPROM.

The EEPROM on the motherboard stores the Setup utility. When you start up the computer, the system provides you with the opportunity to run this program. This appears during the Power-On Self Test (POST). **Press <Delete> to call up the Setup utility.** If you are a little bit late in pressing the mentioned key, POST will continue with its test routines, thus preventing you from calling up Setup. If you still need to call Setup, restart the system by pressing <Ctrl> + <Alt> + <Delete>, or by pressing the Reset button on the system chassis. You can also restart by turning the system off and then back on again, but do so only if the first two methods fail.

The Setup program has been designed to make it as easy to use as possible. It is a menu-driven program, which means you can launch the various pop-up menus and make your selections among the predetermined choices.

**NOTE:** Because the BIOS software is constantly being updated, the following BIOS screens and descriptions are for reference purposes only and may not reflect your BIOS screens exactly.

# 4. BIOS SETUP

---

## 4.2.1 BIOS Menu Bar

The top of the screen has a menu bar with the following selections:

- MAIN** Use this menu to make changes to the basic system configuration.
- ADVANCED** Use this menu to enable and make changes to the advanced features.
- SECURITY** Use this menu to configure and enable the supervisor and user passwords.
- EXIT** Use this menu to exit the current menu or specify how to exit the Setup program.

To access the menu bar items, press the right or left arrow key on the keyboard until the desired item is selected.

## 4.2.2 Navigation Keys

Navigation keys are listed at the bottom of the Setup Help window and in the legend bar located at the bottom of the Setup screen. These keys allow you to navigate through the various Setup menus. The following table lists these keys with their corresponding alternates and functions.

<b>Navigation Key(s)</b>	<b>Function Description</b>
<Esc>	Jumps to the Exit menu or returns to the main menu from a pop-up menu
<Enter>	Brings up a pop-up menu for the selected field
↑ or ↓ (keypad arrow)	Moves the selection up or down between fields
← or → (keypad arrow)	Selects the menu to the left or right
<F5>	Loads the Setup default values
<F6>	Loads the last set values
<F10>	Save changes and exit Setup

## Scroll Bar

When a scroll bar appears to the right of a Setup menu, it indicates that there are more menu items to be displayed that will not fit in the window. Use the up and down arrow keys to scroll through the entire menu.

# 4. BIOS SETUP

---

## Pop-up Menu

Pop-up menus can be launched from fields that are not grayed out. A pop-up menu contains additional options for a field parameter. To call up a pop-up menu, simply move the selection to the field and press <Enter>. The pop-up menu will then immediately appear. Use the legend keys to enter values and move from field to field within a pop-up menu just as you would within a menu. Use the <Esc> key to return to the main menu.

Take some time to familiarize yourself with each of the legend keys and their corresponding functions. Practice navigating through the various menus and pop-up menus. If you accidentally make unwanted changes to any of the fields, use the set default hot key <F5>. While moving around through the Setup program, note that explanations appear in the item specific Setup Help window located to the right of each menu. This window displays the help text for the currently selected field.

**NOTE: SETUP defaults are noted in square brackets next to each function heading.**

# 4. BIOS SETUP

## 4.3 Main Menu

When the Setup program is accessed, the following screen appears:

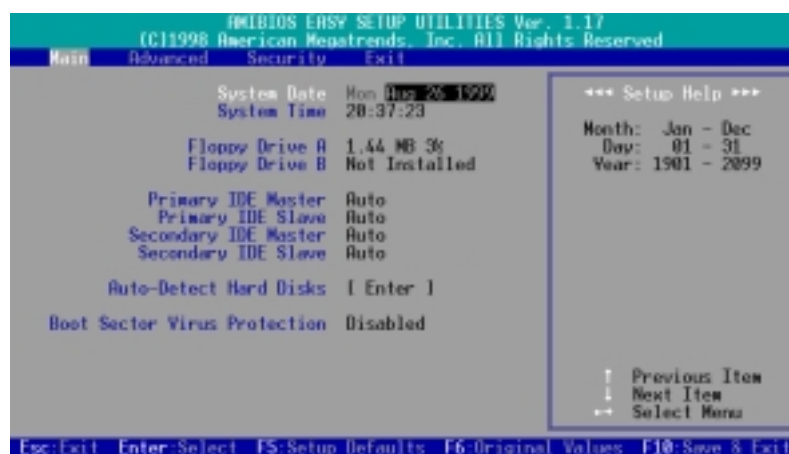

### System Date

To set the date, select this field and then press <+> or <-> to set the current date. Follow the month, day and year format. Valid values for month, day and year are: **Month: (Jan to Dec)**, **Day: (01 to 31)**, **Year: (1901 to 2099)**

### System Time

To set the time, select this field and then press <+> or <-> to set the current time. Follow the hour, minute and second format. Valid values for hour, minute and second are: **(Hour: (00 to 23))**, **(Minute: (00 to 59))**, **(Second: (00 to 59))**.

**NOTE:** You can bypass the date and time prompts by creating an AUTOEXEC.BAT file. For information on how to create this file, refer to the MS-DOS manual.

### Floppy Drive A [1.44 MB 3 1/2] / Floppy Drive B [Not Installed]

These fields record the types of floppy disk drives installed in your system. Available options for drives A and B: [Not Installed] [360KB 5 1/4] [1.2MB 5 1/4] [720KB 3 1/2] [1.44MB 3 1/2] [2.88MB 3 1/2]

### Primary & Secondary IDE Master / Slave [Auto]

See 4.3.1 *Primary & Secondary IDE Master/Slave* for details.

### Auto-Detect Hard Disks

This option detects the parameters of an IDE hard disk drive and automatically enters them into the Main Setup menu. The only difference between this option and the [Auto] option in the **Primary/Secondary IDE Master/Slave** fields is that this option allows the BIOS program to remember the drive information and to skip IDE device detection routines during bootup hereafter. Therefore, the system may not be able to recognize new IDE devices installed after you activate this option and you must select [Auto] for the **IDE Device Configuration** field or manually enter the information for those devices.

# 4. BIOS SETUP

## 4.3.1 Primary & Secondary IDE Master/Slave

Select any one of the four IDE device configuration fields from the main menu and press <Enter>. The default setting [Auto] leads you to a screen as follows:

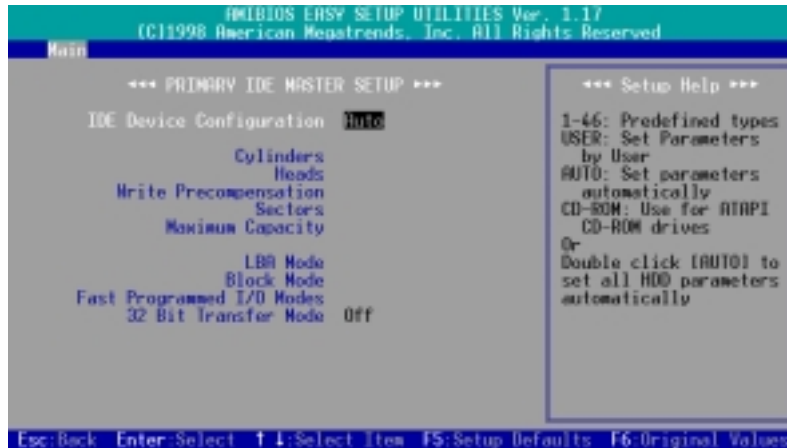

Under the [Auto] setting, the BIOS is able to detect the drive type automatically during bootup. To show the detected hard drive information, press <Enter> when the **IDE Device Configuration** field is selected and the default setting [Auto] is shadowed. In the pop-up menu, select [Auto] and press <Enter> again. The shadowed option for the **IDE Device Configuration** field will turn to [User] and detected values will be filled in for the remaining of the fields (as shown below), but you can still make changes to these fields manually.

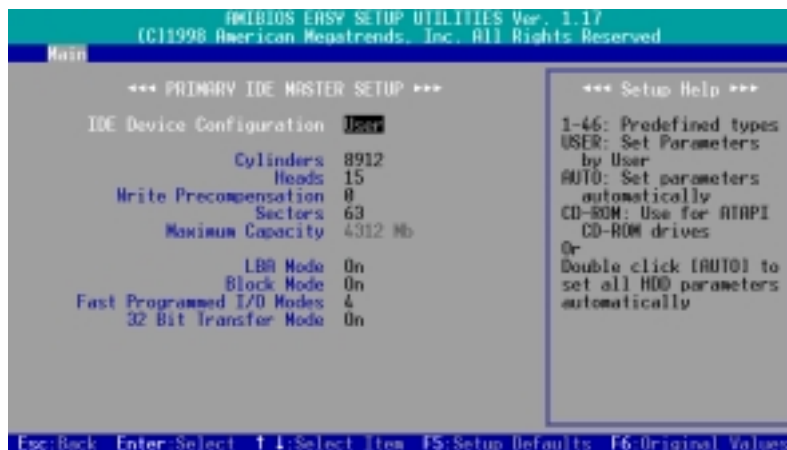

### User Defined Drive Information

You may select [User] for the **IDE Device Configuration** field to manually enter the number of cylinders, heads, sectors, and so on for your drive.

**NOTE:** Before attempting to configure a hard disk drive, make sure you have the configuration information supplied by the manufacturer of the drive. Incorrect settings may cause your system to not recognize the installed hard disk.

## 4. BIOS SETUP

---

### **Cylinders**

This field configures the number of cylinders. Refer to your drive documentation to determine the correct value to enter into this field.

### **Heads**

This field configures the number of read/write heads. Refer to your drive documentation to determine the correct value to enter into this field.

### **Write Precompensation [0]**

Leave on default setting.

### **Sectors**

This field configures the number of sectors per track. Refer to your drive documentation to determine the correct value to enter into this field.

### **Maximum Capacity**

This field shows the drive's maximum capacity.

### **LBA Mode [On]**

When Logical Block Addressing is enabled, 28-bit addressing of the hard drive is used without regard for cylinders, heads, or sectors. Note that Logical Block Access may decrease the access speed of the hard disk. However, LBA Mode is necessary for drives with greater than 504MB in storage capacity. Available options: [Off] [On]

### **Block Mode [On]**

This option enables or disables the multiple sector transfer mode. Available options: [Off] [On]

### **Fast Programmed I/O PIO Modes [4]**

This option lets you set a PIO (Programmed Input/Output) mode for the IDE device. Modes 0 through 5 provide successively increased performance. Available options: [Auto] [0] [1] [2] [3] [4] [5]

### **32 Bit Transfer Mode [On]**

This motherboard supports the 32 bit transfer mode. Leave on default setting.

---

### **Boot Sector Virus Protection [Disabled]**

This field allows you to set boot virus detection, ensuring a virus-free boot sector. The system halts and displays a warning message when it detects a virus. If this occurs, you can either allow the operation to continue or use a virus-free bootable floppy disk to restart and investigate your system. Yet because of conflicts with new operating systems, for example, during installation of new software, the default is set to [Disabled] to prevent write errors.

# 4. BIOS SETUP

## 4.4 Advanced Menu

When the Advanced menu is selected, the following screen appears:

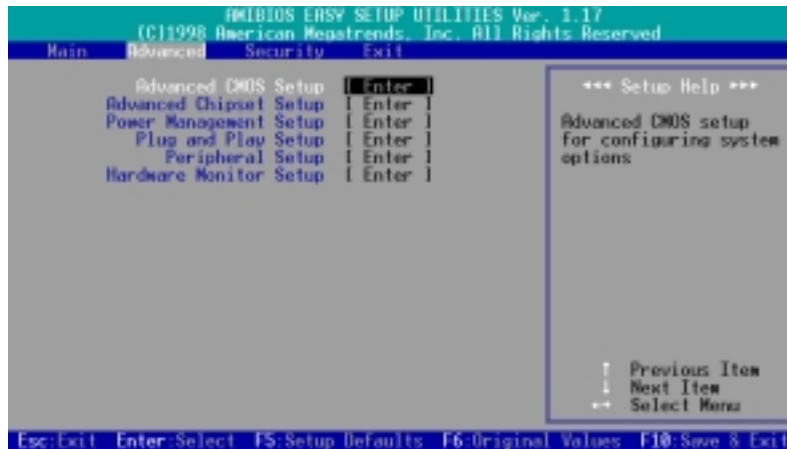

Six sub-menus are listed in this window: **Advanced CMOS Setup**, **Advanced Chipset Setup**, **Power Management Setup**, **Plug and Play Setup**, **Peripheral Setup**, and **Hardware Monitor Setup**. Use the ↑ or ↓ keypad arrow to select the Setup menu you want to configure and then press <Enter>.

# 4. BIOS SETUP

## 4.4.1 Advanced CMOS Setup

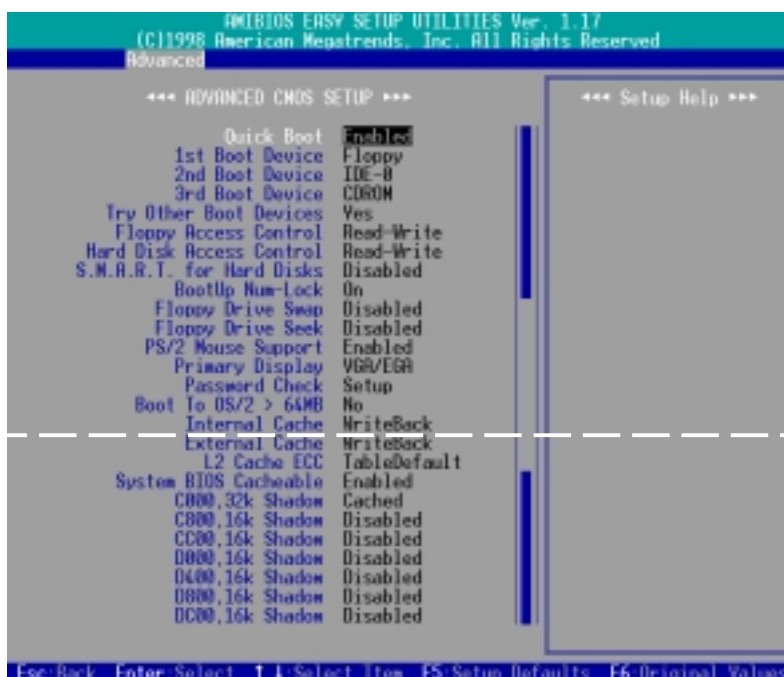

(Scroll down to see more items as shown.)

### Quick Boot [Disabled]

Set this feature to [Enabled] if you want to speed up the bootup by skipping some POST (power-on self test) routines such as memory checking.

### 1st Boot Device [Floppy] / 2nd Boot Device [IDE-0] / 3rd Boot Device [CDROM]

These fields determine where the system looks first for an operating system on system power up. Available options: [Disabled] [IDE-0] [IDE-1] [IDE-2] [IDE-3] [Floppy] [ZIP A:/LS120] [ATAPI ZIP C:] [CDROM] [SCSI] [NETWORK]

### Try Other Boot Devices [Yes]

Selecting [Yes] allows the system to seek other boot devices when those selected in the previous 3 fields fail to boot.

### Floppy / Hard Disk Access Control [Read-Write]

When set to [Read-Only], these fields protect files from being copied to the disk drives by allowing reads from the disk drive but not writes. The Setup default [Read-Write] allows both reads and writes. Available options: [Read-Write] [Read-Only]

### S.M.A.R.T. for Hard Disks [Disabled]

This field enables or disables S.M.A.R.T. (Self-Monitoring Analysis and Reporting Technology) support for S.M.A.R.T.-capable hard disk drives. This technology requires an application that can display S.M.A.R.T. warning messages.

### Boot Up NumLock [On]

This field enables users to activate the Number Lock function upon system boot.



## 4. BIOS SETUP

---

### **Floppy Drive Swap [Disabled]**

This field allows you to reverse the hardware drive letter assignments of your floppy disk drives. Available options: [Disabled] [Enabled]

### **Floppy Drive Seek [Disabled]**

When enabled, the BIOS will seek the floppy disk drive to determine whether the drive has 40 or 80 tracks. Floppy drives with 1.44MB have 80 tracks. You may leave the default [Disabled] to save time if you are using 1.44MB floppy drives.

### **PS/2 Mouse Support [Enabled]**

[Enabled] will reserve IRQ12 for the PS/2 Mouse. If disabled, IRQ12 will be reserved for expansion cards.

### **Primary Display [VGA/EGA]**

Set this field to the type of video display card installed in your system. Available options: [Absent] [VGA/EGA] [CGA40x25] [CGA80x25] [Mono]

### **Password Check [Setup]**

When set to [Always], everytime you start the system, the password set in the Security menu is required. [Setup] requires you to enter the password only when you want to access the BIOS Setup program. Available options: [Setup] [Always]

### **Boot to OS/2 > 64M [No]**

When using OS/2 operating systems with installed DRAM of greater than 64MB, you need to set this field to [Yes]; otherwise leave this on the Setup default of [No].

### **Internal Cache [WriteBack]**

Leave on default setting. [Disabled] turns off the CPU's built-in level 1 cache. Available options: [Disabled] [WriteBack]

### **External Cache [WriteBack]**

Leave on default setting. [Disabled] turns off the CPU's external level 2 cache. Available options: [Disabled] [WriteBack]

### **L2 Cache ECC [TableDefault]**

This function controls the ECC check capability in the CPU level 2 cache. Leave on default setting. Available options: [Disabled] [TableDefault]

### **System BIOS Cacheable [Enabled]**

This feature allows you to cache the system BIOS ROM at F0000h-FFFFFh.

### **C000, 32k Shadow [Cached] / C800 to DC00, 16k Shadow [Disabled]**

These fields are used for shadowing other expansion card ROMs. If you install other expansion cards with ROMs on them, you will need to know which addresses the ROMs use to shadow them specifically. Shadowing a ROM reduces the memory available between 640KB and 1024KB by the amount used for this purpose.

# 4. BIOS SETUP

## 4.4.2 Advanced Chipset Setup

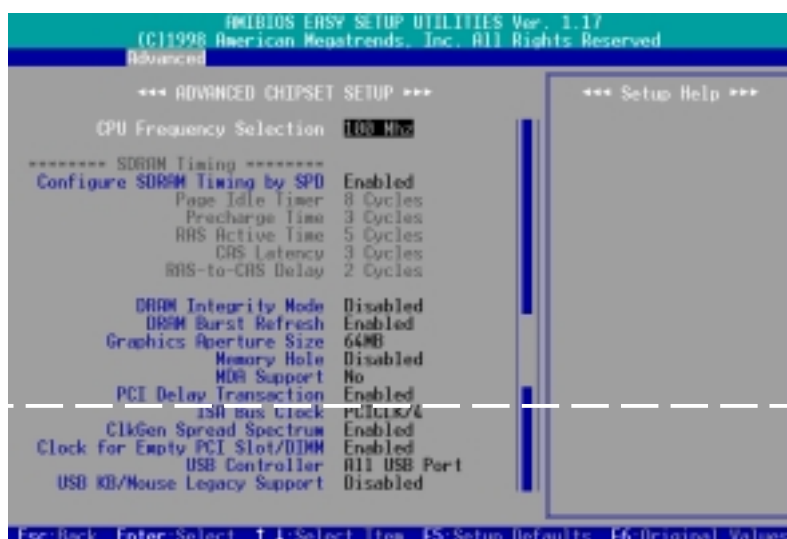

(Scroll down to see more items as shown.)

### CPU Frequency Selection [100Mhz]

This field allows you to select the CPU **external frequency (bus frequency)**, which the clock generator sends to the CPU, DRAM, and PCI bus. The external frequency multiplied by the bus multiple equals the CPU's internal frequency (the advertised **CPU speed**). You may select [By Jumper] to adjust the frequency through the motherboard DIP switches. Available options: [By Jumper] [90 Mhz] [95 Mhz] [100 Mhz]...[150 Mhz]

**WARNING!** Selecting a frequency higher than the CPU manufacturer recommends may cause the system to hang or crash. If you can not start the system after overclocking the CPU, you must clear CMOS to erase your configuration and then the system will be able to run at the Setup default, 100MHz.

### Configure SDRAM Timing by SPD [Enabled]

This sets the optimal timing for the following 5 items, depending on the memory modules that you are using. The Setup default [Enabled] configures the following 5 items by reading the contents in the SPD (Serial Presence Detect) device. This 8-pin serial EEPROM device stores critical parameter information about the module, such as memory type, size, speed, voltage interface, and module banks.

### Page Idle Timer

This controls the amount of time in HCLKs that the DRAM controller waits to close a DRAM page after the CPU becomes idle. **NOTE:** To make changes to this field, the **Configure SDRAM Timing by SPD** field must be set to [Disabled]. Available options: [1 Cycle] [8 Cycles] [32 Cycles] [64 Cycles]

## 4. BIOS SETUP

---

### **Precharge Time**

This controls the idle clocks after issuing a precharge command to the SDRAM.

**NOTE:** To make changes to this field, the **Configure SDRAM Timing by SPD** field must be set to [Disabled]. Available options: [3 Cycles] [2 Cycles] [1 Cycle]

### **RAS Active Time**

This specifies the minimum bank active time. **NOTE:** To make changes to this field, the **Configure SDRAM Timing by SPD** field must be set to [Disabled]. Available options: [2 Cycles] [3 Cycles] [4 Cycles] [5 Cycles] [6 Cycles] [7 Cycles]

### **CAS Latency**

This controls the latency between the SDRAM read command and the time that the data actually becomes available. **NOTE:** To make changes to this field, the **Configure SDRAM Timing by SPD** field must be set to [Disabled]. Available options: [3 Cycles] [2 Cycles] [4 Cycles]

### **RAS-to-CAS Delay**

This controls the latency between the SDRAM active command and the read/write command. **NOTE:** To make changes to this field, the **Configure SDRAM Timing by SPD** field must be set to [Disabled]. Available options: [1 Cycle] [2 Cycles] [3 Cycles] [4 Cycles]

### **DRAM Integrity Mode [Disabled]**

[ECC] with hardware scrubbing allows the detection of single-bit and multiple-bit errors and recovery of single-bit errors. This field is available only if your DIMMs have ECC. Available options: [Disabled] [ECC]

### **DRAM Burst Refresh [Enabled]**

This controls the queuing of refresh requests. When [Enabled], up to four refresh requests are queued before being sent to the memory controller. When [Disabled], refresh requests are only queued if memory requests are currently being serviced.

### **Graphics Aperture Size [64MB]**

This feature allows you to select the size of mapped memory for AGP graphic data. Available options: [32MB] [64MB] [128MB] [256MB] [512MB] [1GB]

### **Memory Hole [Disabled]**

This allows you to specify the memory address space to be reserved for ISA expansion cards that specifically require this setting. Setting the address space to a particular setting will make that memory space unavailable to the system. Expansion cards can only access memory up to 16MB. Available options: [Disabled] [14MB-15MB] [15MB-16MB] [14MB-16MB]

# 4. BIOS SETUP

---

## **MDA Support [No]**

Leave on the default setting [No] unless you are using a monochrome display adapter (MDA).

## **PCI Delay Transaction [Enabled]**

When [Enabled], this frees the PCI Bus during CPU accessing of 8-bit ISA cards that normally consume about 50-60 PCI Clocks without PCI delayed transaction. If PCI Bus Masters cannot use the PCI Bus, select [Disabled] for some ISA cards that are not PCI 2.1 compliant.

## **ISA Bus Clock [PCICLK/4]**

Leave on default settings.

## **ClkGen Spread Spectrum [Enabled]**

Leave on default setting. Spread spectrum typically reduces system electromagnetic interference (EMI) by 8dB to 10dB.

## **ClkGen for Empty PCI Slot/DIMM [Enabled]**

When enabled, this feature generates clock signals for empty PCI slots and DIMM sockets. Disabling this feature will save power and reduce EMI.

## **USB Controller [All USB Port]**

This motherboard supports Universal Serial Bus (USB) devices. You may choose to enable part or all of the USB ports. Available options: [Disabled] [USB Port 0&1] [USB Port 2&3] [All USB Port]

## **USB KB/Mouse Legacy Support [Disabled]**

Leave on the default setting [Disabled] if you are not using any USB legacy devices. Available options: [Disabled] [Keyboard] [Keyb+Mouse]

# 4. BIOS SETUP

## 4.4.3 Power Management Setup

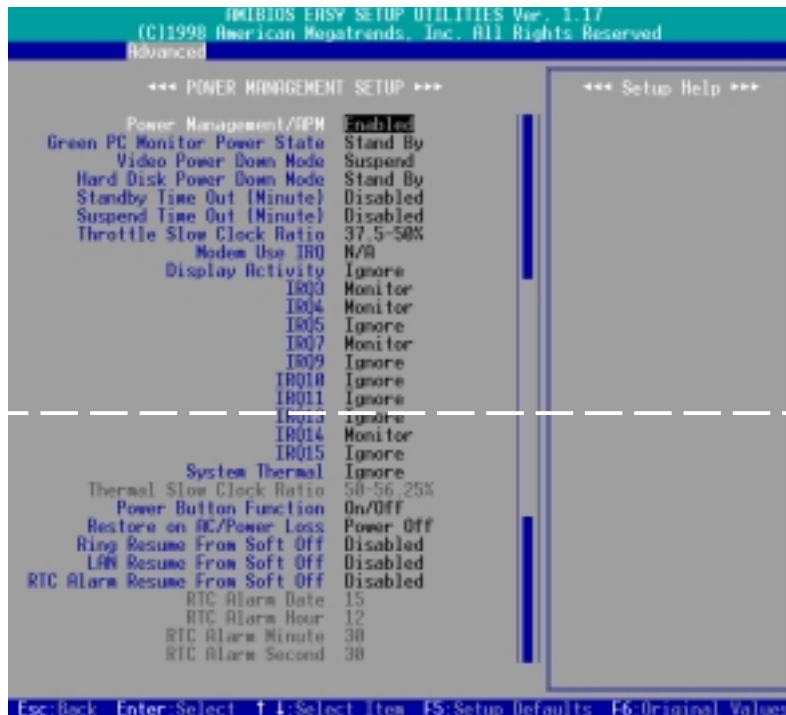

(Scroll down to see more items as shown.)

### Power Management/APM [Enabled]

Advanced Power Management (APM) is an application program interface that includes power management in the BIOS. Leave on the Setup default [Enabled].

**NOTE: To access the following 18 BIOS power management features, you must set this field to [Enabled].**

### Green PC Monitor Power State [Stand by] (\*APM feature)

This field sets the state of the green monitor in use when the system enters power-saving mode. Available options: [Stand By] [Suspend] [Off]

### Video Power Down Mode [Stand By] (\*APM feature)

This field determines when to power down the monitor for monitor power management. The monitor automatically wakes up when any specified system activity is detected. Available options: [Disabled] [Stand By] [Suspend]

### Hard Disk Power Down Mode [Disabled] (\*APM feature)

This field sets when to power down all the IDE hard disk drives in the system. The hard disks automatically wake up when any specified system activity is detected. Available options: [Disabled] [Stand By] [Suspend]

### Standby / Suspend Time Out (Minute) [Disabled] (\*APM feature)

These fields set the period of inactivity before the system is put to standby/ suspend mode. The system automatically wakes up when any specified system activity is detected. Available options: [Disabled] [1] [2] [4] [8] [10] [20] [30] [40] [50] [60]

## 4. BIOS SETUP

---

### **Throttle Slow Clock Ratio [37.5-50%] (\*APM feature)**

This field determines the duty cycle of the STPCLK# signal when the system is in throttling mode. In other words, it configures the percentage by which the CPU slows down when the system enters power-saving mode.

### **Modem Use IRQ [N/A] (\*APM feature)**

Leave on default setting.

### **Display Activity [Ignore] (\*APM feature)**

Set this field to [Monitor] if you want the system to monitor any display activity that takes place while the system is in power-saving mode. Available options: [Ignore] [Monitor]

### **IRQ3 to IRQ15 (\*APM feature)**

Select [Monitor] if you want the system to wake up from power-saving mode when there is activity detected from the specified IRQ channels. Available options: [Ignore] [Monitor]

### **System Thermal [Ignore]**

The onboard hardware monitor is able to detect the CPU and motherboard temperatures. Set to [Monitor] to use this feature.

### **Thermal Slow Clock Ratio [50-56.25%]**

This field determines the duty cycle of the STPCLK# signal when the THRM# pin is asserted low. In other words, this feature sets the percentage by which the CPU slows down when the CPU is overheated. **NOTE:** To access this field, the **System Thermal** field must be set to [Monitor].

### **Power Button Function [On/Off]**

When set to [On/Off], the ATX switch can be used as a normal system power-off button when pressed for less than 4 seconds. [Suspend] allows the button to have a dual function where pressing less than 4 seconds will place the system in sleep mode. Regardless of the setting, holding the ATX switch for more than 4 seconds will power off the system. **NOTE:** This field is only effective in APM OS system. Available options: [On/Off] [Suspend]

### **Restore on AC/Power Loss [Power Off]**

This allows you to set whether you want your system to reboot after the power has been interrupted. [Power Off] leaves your system off after reapplying power and [Power On] boots up your system after reapplying power. [Last state] returns your computer back to the state it is in before the power failure.

# 4. BIOS SETUP

---

## Ring Resume from Soft Off [Disabled]

This allows either setting of [Enable] or [Disable] for powering up the computer (turns the ATX power supply on) when the modem receives a call while the computer is off. **NOTE:** The computer cannot receive or transmit data until the computer and applications are fully running. Therefore connection cannot be made on the first try. Turning an external modem off and then back on while the computer is off causes an initialization string that will also cause the system to power on.

## LAN Resume from Soft Off [Disabled]

This allows you to remotely power up your system through your network by sending a wake-up frame or signal. With this feature, you can remotely upload/download data to/from systems during off-peak hours. Set to [Enabled] to use this feature.

**IMPORTANT:** This feature requires the ASUS PCI-L101 LAN Card (see **APPENDIX**) or a similar ethernet card and an ATX power supply with at least 720mA +5V standby power.

## RTC Alarm Resume From Soft Off [Disabled]

### RTC Alarm Date / Hour / Minute / Second

This allows you to have an unattended or automatic power up of your system. You may use the four parameters (**Date, Hour, Minute, and Second**) to configure your system to power up at a certain time of a day in a month by setting **RTC Alarm Resume From Soft Off** to [Enabled].

# 4. BIOS SETUP

## 4.4.4 Plug and Play Setup

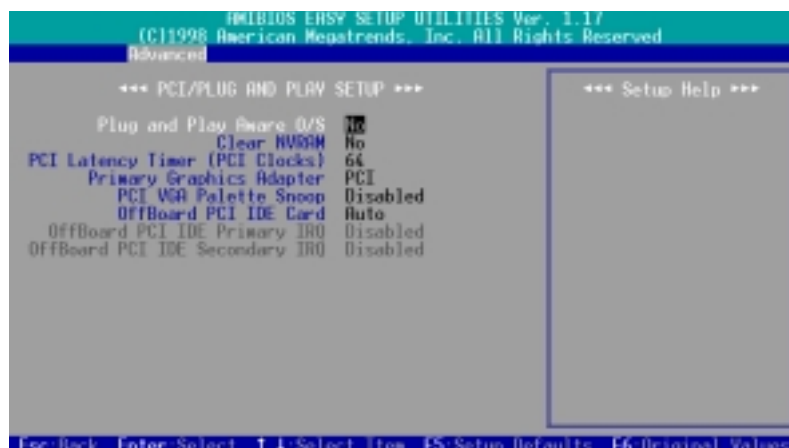

### Plug and Play Aware O/S [No]

This field allows you to use a Plug-and-Play (PnP) operating system to configure the PCI bus slots instead of using the BIOS. Thus interrupts may be reassigned by the OS when [Yes] is selected. When a non-PnP OS is installed or to prevent reassigning of interrupt settings, select the default setting of [No].

### Clear NVRAM [No]

Non-Volatile Random Access Memory (NVRAM) retains its contents when the computer is turned off. NVRAM is used to store essential information such as device node data, and Setup parameters. Select [Yes] only if you want to clear these data during the Power-On Self Test (POST).

### PCI Latency Timer (PCI Clocks) [64]

Leave on default setting for best performance vs. stability.

### Primary Graphics Adapter [PCI]

If your computer has both PCI and AGP VGA cards, this field allows you to select which of the cards will act as your primary graphic card. [AGP] uses the AGP card as your primary card. The default, [PCI], allows your PCI graphic card to take precedent when detected.

### PCI/VGA Palette Snoop [Disabled]

Some nonstandard VGA cards, such as graphics accelerators or MPEG Video Cards, may not show colors properly. The setting [Enabled] should correct this problem. Otherwise, leave this on the default setting of [Disabled].

### OffBoard PCI IDE Card [Auto]

This feature allows you to use a PCI IDE controller card. You may specify a PCI slot for the card or leave the default setting of [Auto] to use the card on any of the PCI slots. Available options: [Auto] [Slot1] [Slot2] [Slot3]



# 4. BIOS SETUP

---

## **OffBoard PCI IDE Primary/Secondary IRQ [Disabled]**

This feature selects the interrupt routing for add-on PCI IDE devices. A single-function PCI device can only use INTA# pin. Multi-function PCI devices can use all the pins. The option [Hardwired] means, instead of leaving the interrupt routing to the control of the BIOS, the interrupt request lines on the add-on PCI IDE card are wired to the ISA interrupt controller. **NOTE:** These two fields are only accessible when you assign a slot to the **OffBoard PCI IDE Card**. Available options: [Disabled] [INTA] [INTB] [INTC] [INTD] [Hardwired]

# 4. BIOS SETUP

## 4.4.5 Peripheral Setup

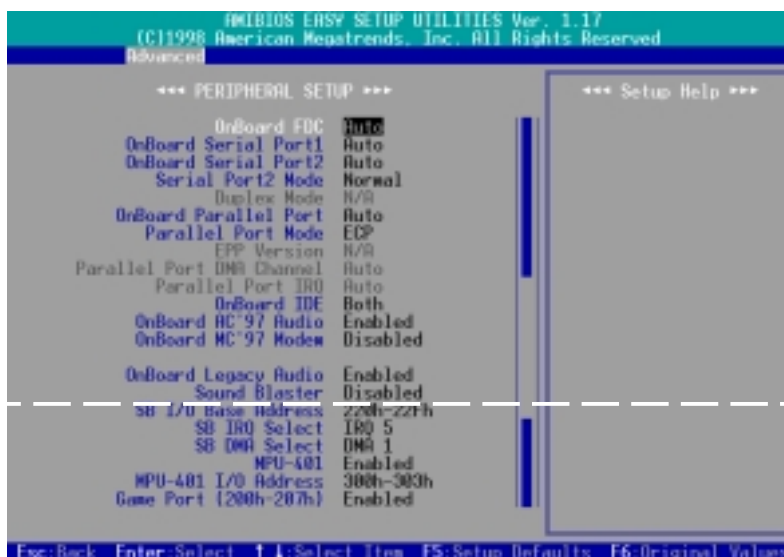

(Scroll down to see more items as shown.)

### Onboard FDC [Auto]

[Auto] allows the motherboard to detect whether you have a separate floppy disk drive controller (FDC). If a separate card is detected, the onboard FDC will be disabled. If no separate card is detected, the onboard FDC will be enabled. When [Enabled] is selected, you may connect your floppy disk drives to the onboard floppy disk drive connector without using a separate controller card. If you want to use a different controller card to connect the floppy disk drives, set this to [Disabled].

### OnBoard Serial Port1 / OnBoard Serial Port2 [Auto]

These fields allow you to set the addresses and COM ports for the onboard serial connectors. [Auto] detects whether you are using any devices on these connectors. If yes, the BIOS program automatically assigns addresses and COM ports for these connectors. You may also select addresses and ports manually, but Serial Port 1 and Serial Port 2 must have different addresses. [Disabled] prevents the serial ports from working. Available options: [Auto] [Disabled] [3F8/COM1] [2F8/COM2] [3E8/COM3] [2E8/COM4]

### Serial Port2 Mode [Normal]

If your system already has a second serial port connected to the onboard COM2 connector and you do not want to use the infrared feature, leave on the default setting [Normal]. The option [IrDA] reserves the serial port 2 for IrDA infrared communications while the option [ASK IR] reserves the serial port 2 for Amplitude Shift Keyed (ASK) infrared communications.

### Duplex Mode [N/A]

This field is only selectable when **Serial Port2 Mode** is set to [IrDA] or [ASK IR]. Available options when enabled: [Half Duplex] [Full Duplex]

## 4. BIOS SETUP

---

### **Onboard Parallel Port [Auto]**

This field sets the address of the onboard parallel port connector. Available options: [Auto] [Disabled] [378] [278] [3BC]

### **Parallel Port Mode [ECP]**

[Normal] allows normal-speed operation but in one direction only; [EPP] allows bidirectional parallel port operation; [ECP] allows the parallel port to operate in bidirectional DMA mode. **NOTE:** To make changes to this field, **Onboard Parallel Port** can not be set to [Disabled]. Available options: [Normal] [ECP] [EPP]

### **EPP Version**

This field allows you to select between EPP version 1.9 and 1.7. **NOTE:** To make changes to this field, **Parallel Port Mode** must be set to [EPP].

### **Parallel Port DMA Channel / Parallel Port IRQ**

Leave on default setting.

### **Onboard IDE [Both]**

You can select to enable the primary IDE channel, secondary IDE channel, both, or disable both channels. Available options: [Disabled] [Primary] [Secondary] [Both]

### **Onboard AC'97 Audio [Enabled]**

This field allows you to enable or disable the onboard AC'97 audio feature. If you want to use your own audio devices, you may set this to [Disabled].

### **Onboard MC'97 Modem [Disabled]**

This field allows you to enable or disable the onboard AC'97 modem feature. If you want to use your own modem devices, leave on the Setup default [Disabled].

### **Onboard Legacy Audio [Enabled]**

Enable this field if you want to use legacy audio devices onboard. **NOTE:** To make changes to the rest of the items, this field must be enabled.

### **Sound Blaster [Disabled]**

Select [Enabled] for this field if you are using Sound Blaster™ sound card.

### **SB I/O Base Address / SB IRQ Select / SB DMA Select**

These fields set the I/O address, IRQ, and DMA channel for the Sound Blaster™ sound card. **NOTE:** To access these fields, the **Sound Blaster** field must be enabled.

### **MPU-401 [Disabled]**

Enable this field if you want to use a MIDI device onboard.

### **MPU-401 I/O Address [300h-303h]**

This sets the I/O address for the onboard MIDI device. To access this field, the **MPU-401** field must be enabled.

### **Game Port (200h-207h) [Enabled]**

Enable this field to use the game port.

# 4. BIOS SETUP

## 4.4.6 Hardware Monitor Setup

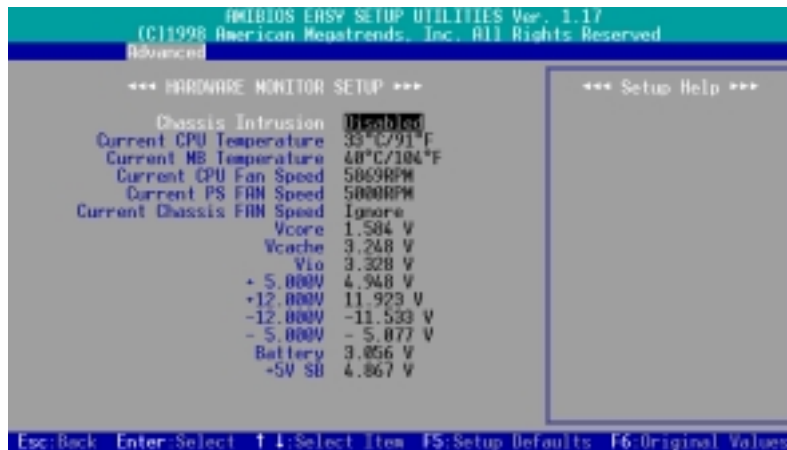

### Chassis Intrusion [Disabled]

This motherboard has a chassis intrusion alarm lead. You must install an external detection mechanism and enable this field to make it work. If the chassis is opened when this feature is enabled, select [Reset] to disable the sounding of the alarm. Available options: [Disabled] [Enabled] [Reset]

### Current CPU / MB Temperature [xxxC/xxxF]

The onboard hardware monitor is able to detect the CPU and MB (motherboard) temperatures. Set to [Ignore] only if necessary.

### Current CPU Fan / PS Fan / Chassis Fan Speed [xxxxRPM]

The onboard hardware monitor is able to detect the CPU fan speed, power supply fan speed, and the chassis fan speed in rotations per minute (RPM). The presence of the fans is automatically detected. Set to [Ignore] only if necessary.

### VCORE Voltage / Vcache / Vio / +5.000V / +12.000V / -12.000V / -5.000V / Battery / +5V SB [xx.xxxV]

The onboard hardware monitor is able to detect the voltage output by the onboard voltage regulators. Set to [Ignore] only if necessary.

# 4. BIOS SETUP

## 4.5 Security Menu

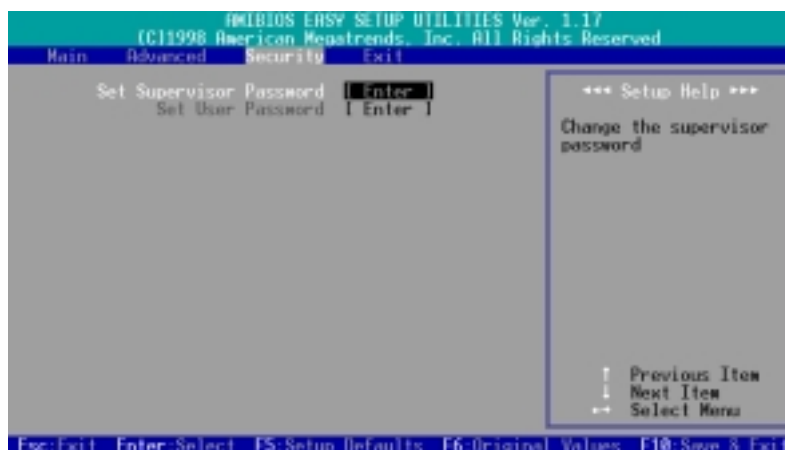

### Set Supervisor Password / Set User Password

These two options set the system passwords. “Supervisor Password” sets a password that will be used to protect the system and the Setup utility; “User Password” sets a password that will be used exclusively on the system. By default, the system comes without any passwords. To specify a password, select the type you want and then press <Enter>. A password prompt appears on the screen. Taking note that the password is case sensitive, and can be up to 8 alphanumeric characters long. Type in your password and then press <Enter>. The system confirms your password by asking you to type it again.

To implement password protection, specify in the “Advanced CMOS Setup” screen when the system will prompt for the password. If you want to disable either password, press <Enter> instead of entering a new password when the “Enter Password” prompt appears. A message confirms the password has been disabled.

### Forgot the password?

If you forgot the password, you can clear the password by erasing the CMOS Real Time Clock (RTC) RAM. The RAM data containing the password information is powered by the onboard button cell battery. To erase the RTC RAM: (1) Unplug your computer, (2) Short the solder points, (3) Turn ON your computer, (4) Hold down <Delete> during bootup and enter BIOS Setup to re-enter user preferences.

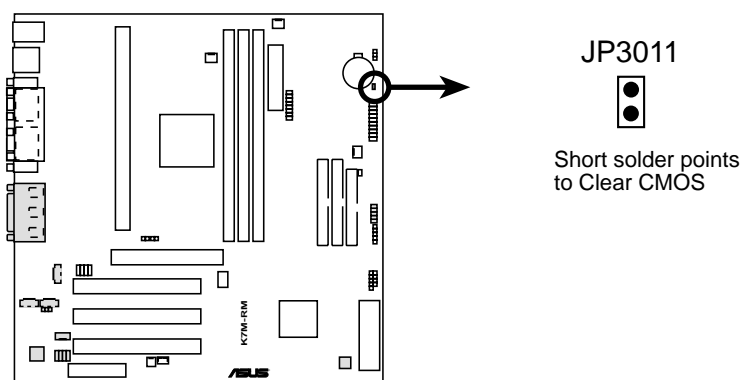

K7M-RM Clear RTC RAM

# 4. BIOS SETUP

## 4.6 Exit Menu

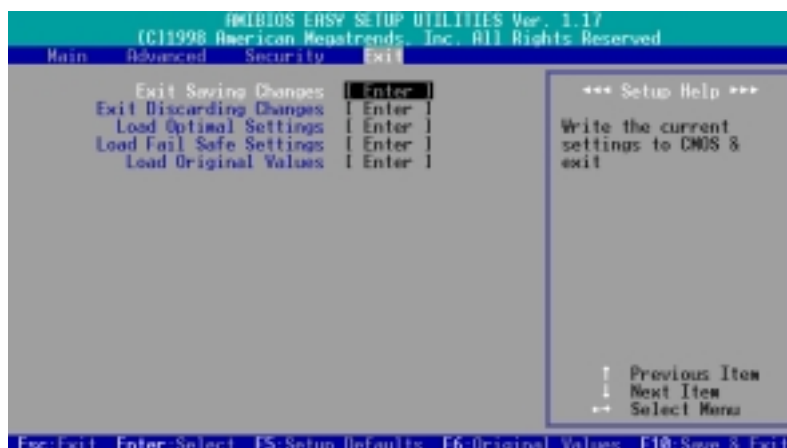

### Exit Saving Changes

Select this option to save into the CMOS memory all modifications you specified during the current session. To save the configuration changes, select this option, press <Enter> and then press <Enter> again to confirm your choice.

### Exit Discarding Changes

Select this option to exit the Setup utility without saving the modifications you specify during the current session. To exit without saving, select this option, press <Enter> and then press <Enter> again to confirm your choice.

### Load Optimal Settings (Setup Defaults)

This option allows you to load the optimal value (default value) for each of the parameters on the Setup menus. If you press <Enter> when this option is selected or if <F5> is pressed, a confirmation is requested. Press <Enter> to load the optimal settings. You can now select **Exit Saving Changes** or make other changes before saving the values to the non-volatile RAM.

### Load Fail Safe Settings

This option allows you to load the fail-safe value for each of the parameters on the Setup menus. Press <Enter> and then press <Enter> again to confirm your choice. You can now select **Exit Saving Changes** or make other changes before saving the values to the non-volatile RAM.

### Load Original Values

This option allows you to load the last-saved values for each of the parameters on the Setup menus. Press <Enter> and then press <Enter> again to confirm your choice. You can now select **Exit Saving Changes** or make other changes before saving the values to the non-volatile RAM.

# 5. SOFTWARE SETUP

---

## 5.1 Operating Systems

You should always use the latest operating system and updates when using new hardware to ensure full compliancy. For Windows 95, you must use OSR 2.0 or later. For Windows NT 4.0, you must use Service Pack 3.0 or later.

### 5.1.1 Windows 98 First Time Installation

When you start Windows for the first time after the installation of your motherboard, Windows 98 will detect the onboard audio and video chips and may attempt to install a driver from its system registry. When prompted to restart, select **No** and then follow the normal setup procedures later in this section.

**IMPORTANT:** Selecting **No** for the initial restart prompt is a necessary step because Windows may load an older display driver that is incompatible with the onboard VGA chip. Always use the driver available on the Support CD or an applicable driver update from your vendor.

**NOTE:** The screen displays in this and the following section may not reflect exactly the screen contents displayed on your screen.

# 5. SOFTWARE SETUP

## 5.2 K7M-RM Support CD

**NOTE:** The support CD contents are subject to change at any time without notice.

To begin using your support CD disc, just insert it into your CD-ROM drive and the support CD installation menu should appear. If the menu does not appear, double-click or run **D:\ASSETUP.EXE** (assuming that your CD-ROM drive is drive **D:**).

### 5.2.1 Installation Menu



- **Show MB Information:** Allows you to view information about your motherboard, such as product name, BIOS version, and CPU.
- **Browse CD Content:** Allows you to view the contents of the CD.
- **Audio Driver (Optional):** Installs the necessary audio drivers and utilities to access the features of the built-in PCI audio chipset.
- **PC-cillin 98:** Installs the PC-cillin virus protection software. View the online help for more information.
- **Acrobat Reader V4.0:** Installs the Adobe Acrobat Reader software necessary to view user's manuals saved in PDF format. Updated or other language versions of this motherboard's manual is available in PDF format at any of our web sites.
- **IDE Driver:** Installs VIA Bus Master PCI IDE Controller Driver.
- **Miniport Driver:** Installs the necessary AGP miniport driver for the K7 Series motherboards with AMD-751 chipset under Windows 9x.
- **ASUS PC Probe:** Installs a simple utility to monitor your computer's fan, temperature, and voltages.
- **YAMAHA S-YXG50 (Optional):** Installs the YAMAHA SoftSynthesizer for playing MIDI files through software. Refer to the online help for more information.
- **YAMAHA XGStudio (Optional):** Installs the YAMAHA XGstudio Mixer for mixing MIDI files.

(TO SEE THE FOLLOWING ITEM, CLICK RIGHT ARROW ON THE LOWER-RIGHT CORNER OF THE MAIN MENU.)

- **EXIT:** Exits the CD installation menu. (Click **RIGHT ARROW** on the lower-right corner of the main menu.)

**Additional CD Content:** Flash BIOS writer in the **FLASH** folder.



# 5. SOFTWARE SETUP

## 5.3 Audio Driver (only with onboard audio option)

Insert the Support CD that came with your motherboard into your CD-ROM drive or double-click the CD drive icon in **My Computer** to bring up the setup screen.

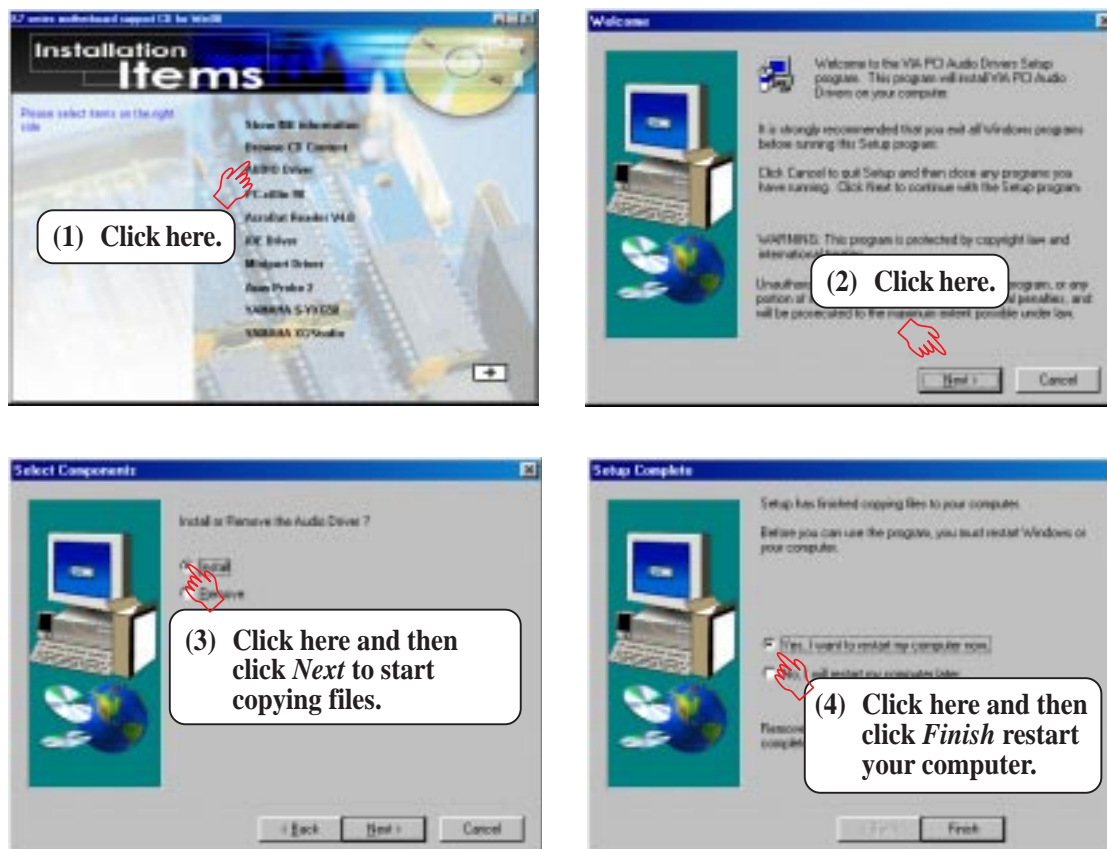

**NOTE:** You may choose to restart your computer later when this option is offered, especially if you still want to install other drivers and/or software. You may not, however, be able to use immediately the devices associated with the drivers or software because these drivers need to be enabled. These drivers are enabled when Windows starts/restarts.

### For Windows 95

1. When the *New Hardware Found* screen prompts for a driver, select **Driver from disk provided by hardware manufacturer** and insert the Support CD into your CD-ROM drive.
2. Click **OK**.
3. Click **Browse**.
4. Locate the **D:\Audio\WIN9X** folder (where D is your CD-ROM Drive) and click **OK**.
5. Click **OK** again and the driver files will be copied.
6. Click **Yes** to restart the computer.

# 5. SOFTWARE SETUP

## 5.4 PC-cillin 98

Insert the Support CD that came with your motherboard into your CD-ROM drive or double-click the CD drive icon in **My Computer** to bring up the setup screen.

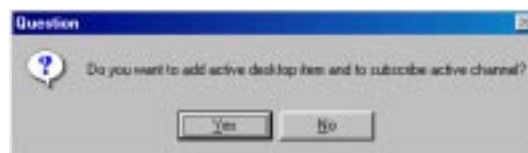
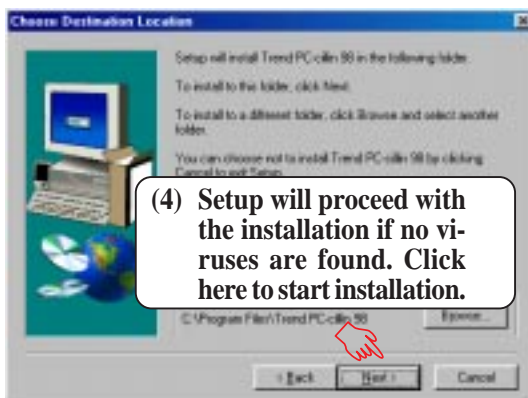
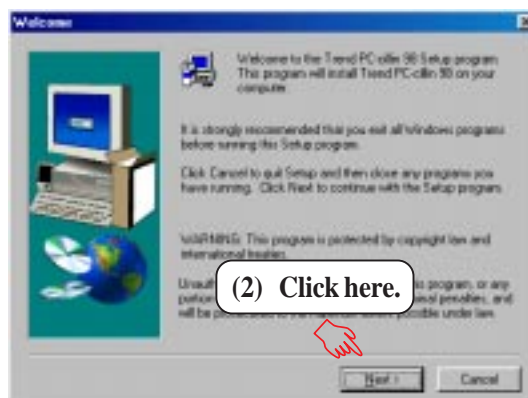

(6) & (7) Select the preferred features by clicking the appropriate buttons.

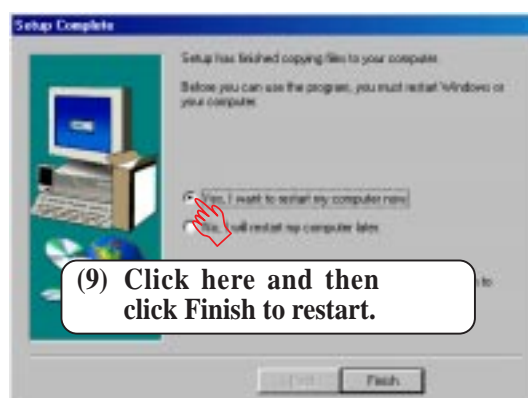
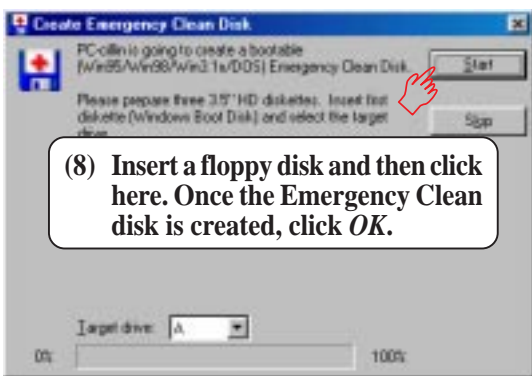
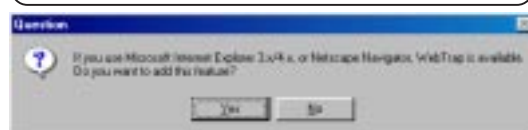

# 5. SOFTWARE SETUP

## 5.5 Acrobat Reader Vx.x

Insert the Support CD that came with your motherboard into your CD-ROM drive or double-click the CD drive icon in **My Computer** to bring up the setup screen.

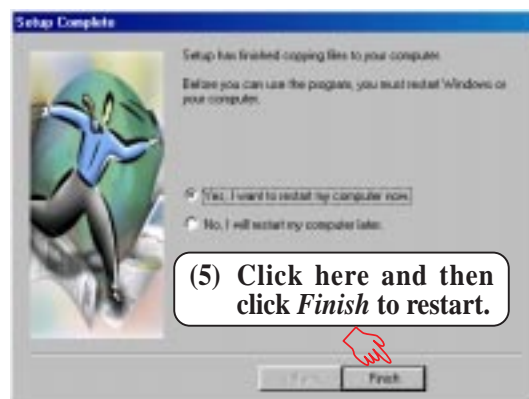
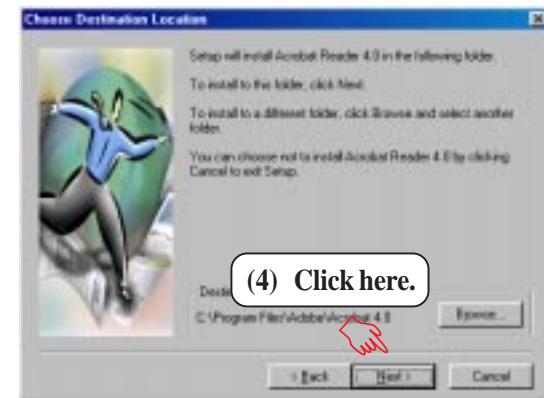
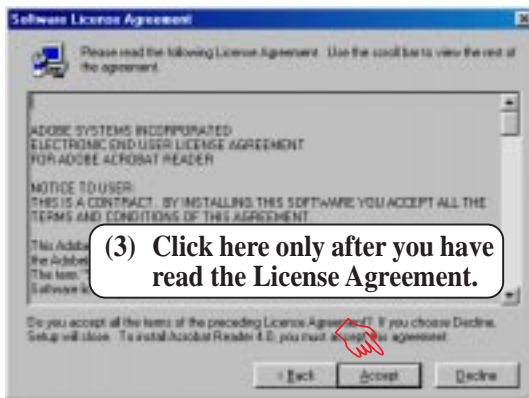
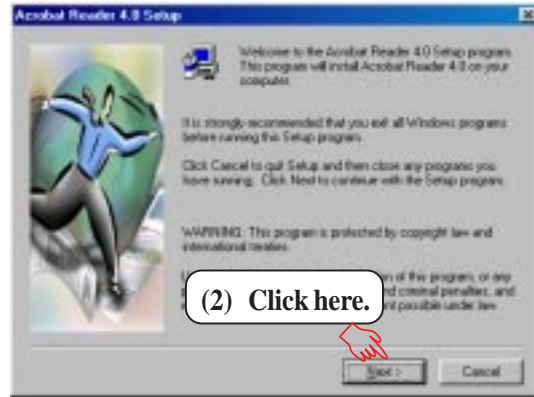

# 5. SOFTWARE SETUP

## 5.6 IDE Driver

Insert the Support CD that came with your motherboard into your CD-ROM drive or double-click the CD drive icon in **My Computer** to bring up the setup screen.

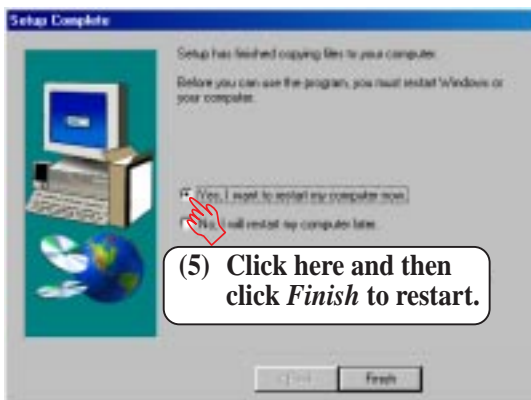



# 5. SOFTWARE SETUP

## 5.7 Miniport Driver

Insert the Support CD that came with your motherboard into your CD-ROM drive or double-click the CD drive icon in **My Computer** to bring up the setup screen.

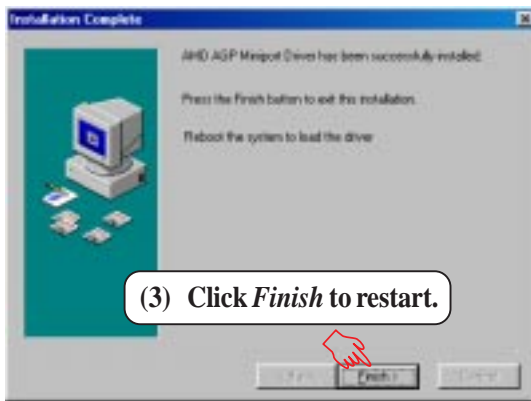
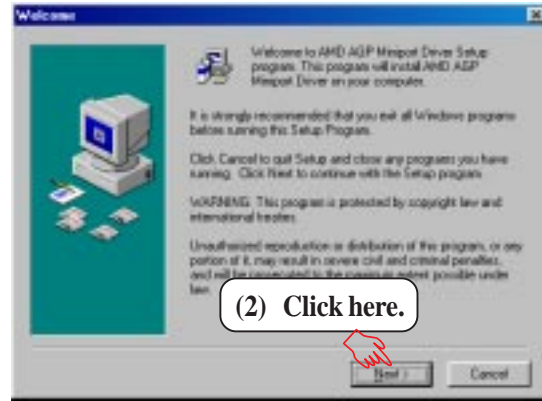

# 5. SOFTWARE SETUP

## 5.8 ASUS PC Probe

Insert the Support CD that came with your motherboard into your CD-ROM drive or double-click the CD drive icon in **My Computer** to bring up the setup screen.

**NOTE:** ASUS PC Probe will not run if another hardware monitoring utility is installed. To uninstall any program, see *5.12 Uninstalling Programs*.

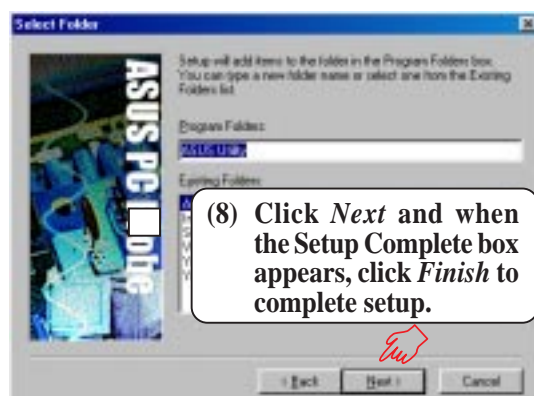
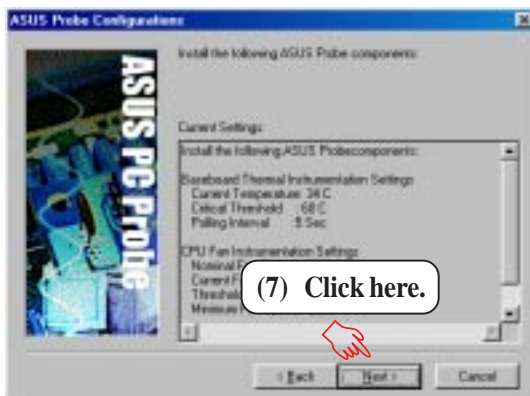
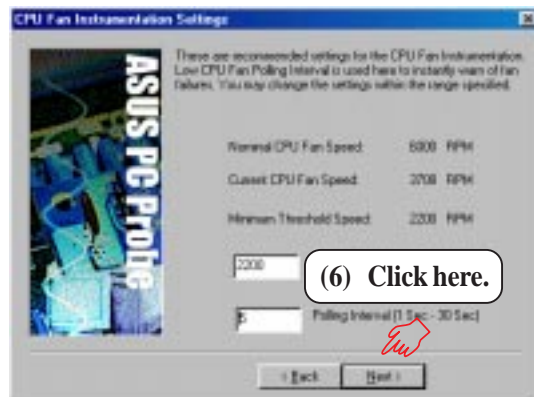
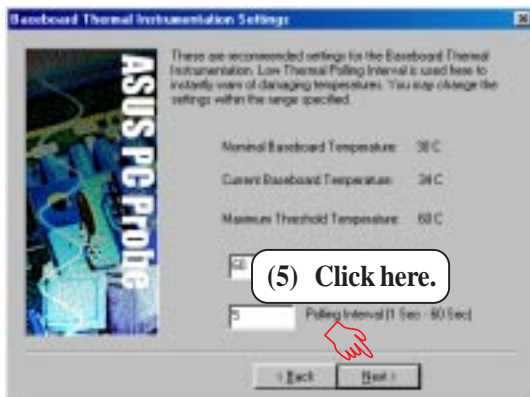
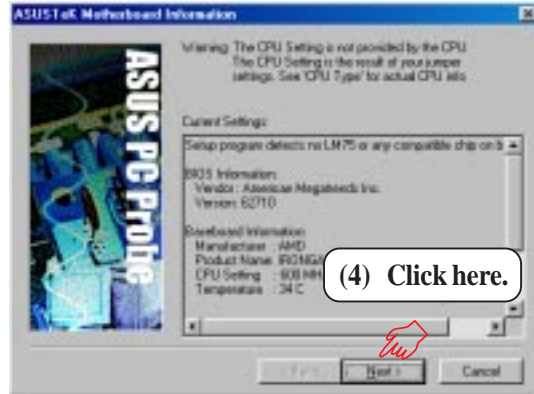
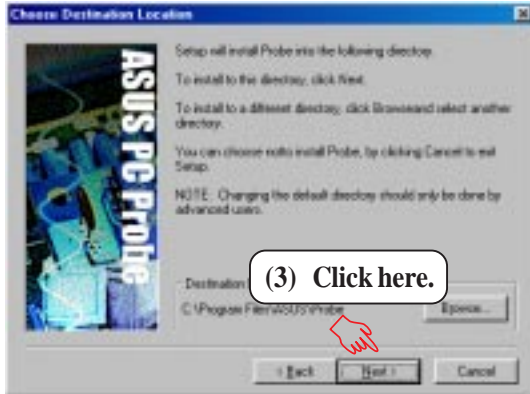
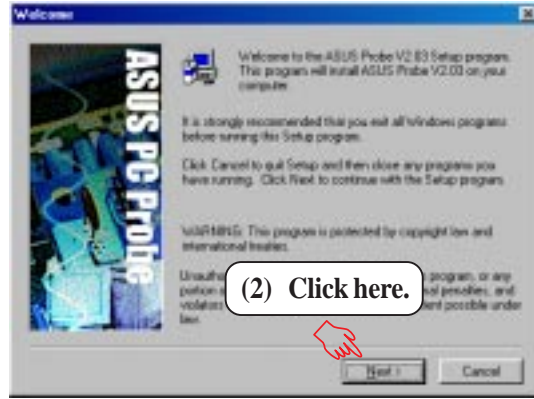

# 5. SOFTWARE SETUP

## 5.9 YAMAHA S-YXG50

(only with onboard audio option)

Insert the Support CD that came with your motherboard into your CD-ROM drive or double-click the CD drive icon in **My Computer** to bring up the setup screen.

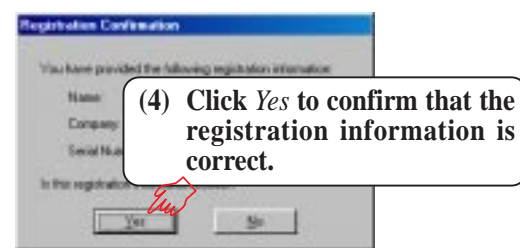
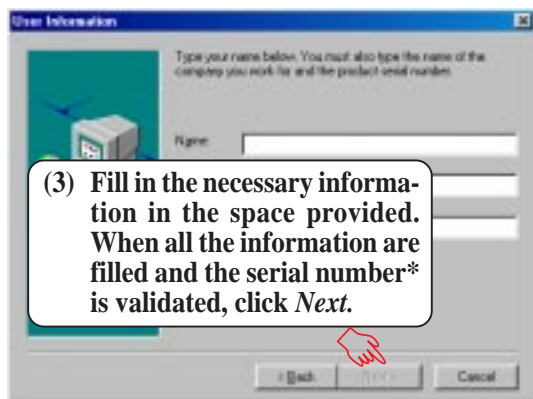
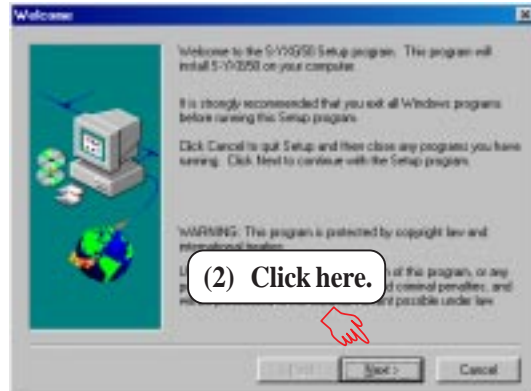

\*The product serial number can be found on this software's license agreement card.

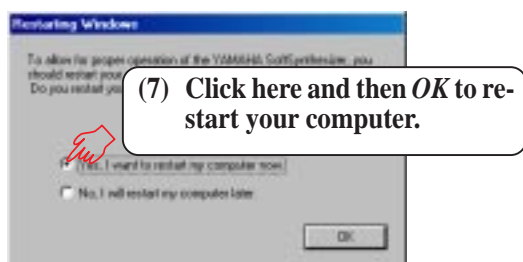
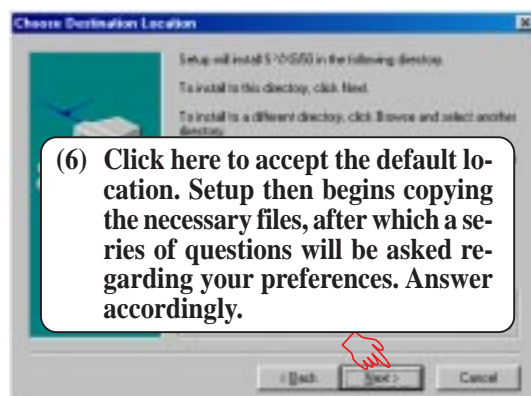
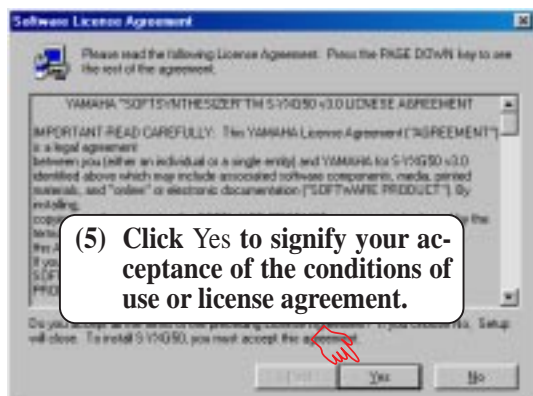

# 5. SOFTWARE SETUP

## 5.10 YAMAHA XGStudio

(only with onboard audio)

Insert the Support CD that came with your motherboard into your CD-ROM drive or double-click the CD drive icon in **My Computer** to bring up the setup screen.

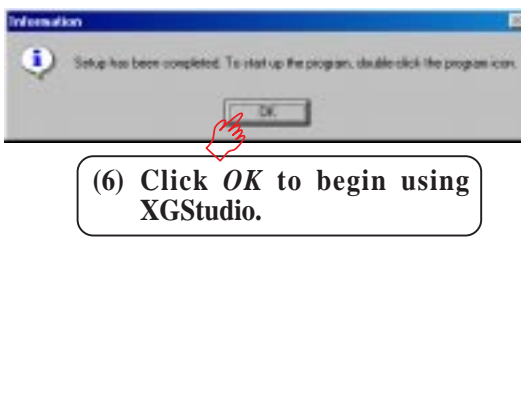
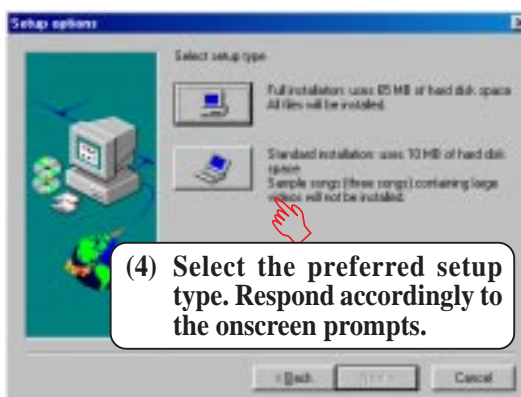
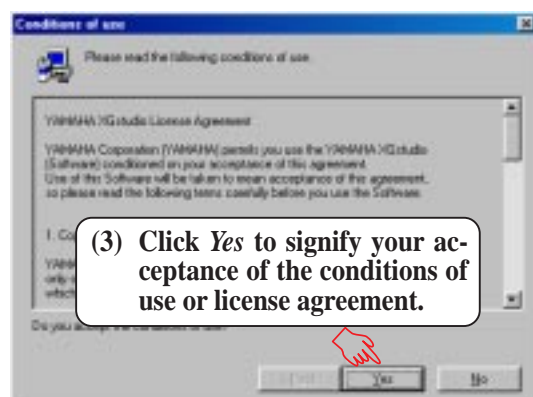



# 5. SOFTWARE SETUP

## 5.11 Uninstalling Programs

Add/Remove Programs is a basic component within Windows. You may use this function if a program does not provide its own uninstallation program.

(1) Double-click here to open the *Add/Remove Programs Properties* dialog box.

(2) Select the program to remove and click here.

(3) Click here.

---

(This page was intentionally left blank.)

# 6. SOFTWARE REFERENCE

## 6.1 ASUS PC Probe

ASUS PC Probe is a convenient utility to continuously monitor your computer system's vital components, such as fan rotations, voltages, and temperatures. It also has a utility that lets you review useful information about your computer, such as hard disk space, memory usage, and CPU type, CPU speed, and internal/external frequencies through the DMI Explorer.

### 6.1.1 Starting ASUS PC Probe

When ASUS PC Probe starts, a splash screen appears allowing you to select whether to show the screen again when you open PC Probe or not. To bypass this startup screen, clear the **Show up in next execution** check box.

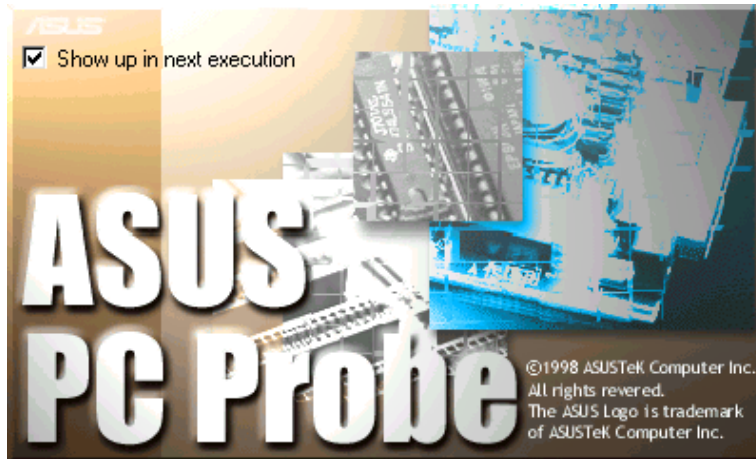

To open **ASUS PC Probe**, click the Windows **Start** button, point to **Programs**, and then **ASUS Utility**, and then click **Probe Vx.xx**.

The PC Probe icon  will appear on the taskbar's system tray indicating that ASUS PC Probe is running. Clicking the icon will allow you to see the status of your PC.

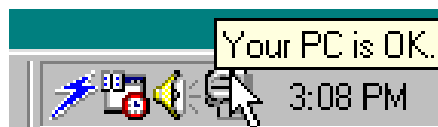

# 6. SOFTWARE REFERENCE

## 6.1.2 Using ASUS PC Probe

### Monitoring

#### Monitor Summary

Shows a summary of the items being monitored.



#### Temperature Monitor

Shows the PC's temperature.

Temperature Warning threshold adjustment  
(Move the slider up to increase the threshold level or down to decrease the threshold level)



#### Fan Monitor

Shows the PC's fan rotation.

Fan Warning threshold adjustment  
(Move the slider up to increase the threshold level or down to decrease the threshold level)

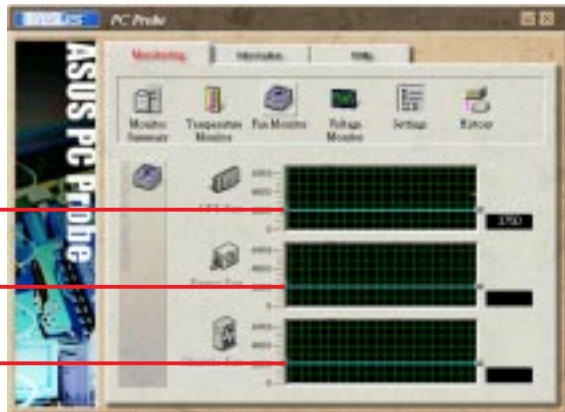

#### Voltage Monitor

Shows the PC's voltages.



# 6. SOFTWARE REFERENCE

## Settings

Lets you set threshold levels and polling intervals or refresh times of the PC's temperature, fan rotation, and voltages.



## History

Lets you record the monitoring activity of a certain component of your PC by date, time, and target history.



## Information

### Hard Drives

Shows the used and free space of the PC's hard disk drives and the file allocation table or file system used.



### Memory

Shows the PC's memory load, memory usage, and paging file usage.





# 6. SOFTWARE REFERENCE

## Device Summary

Shows a summary of devices in your PC.



## DMI Explorer

Shows information pertinent to the PC, such as CPU type, CPU speed, and internal/external frequencies, and memory size.



## Utility

Lets you run programs outside of the ASUS Probe modules. To run a program, click **Execute Program**.



## 6. SOFTWARE REFERENCE

### 6.1.3 ASUS PC Probe Task Bar Icon

Right clicking the PC Probe icon will bring up a menu to open or exit ASUS PC Probe and pause or resume all system monitoring.



When the ASUS PC Probe senses a problem with your PC, portions of the ASUS PC Probe icon changes to red, the PC speaker beeps, and the ASUS PC Probe monitor is displayed.

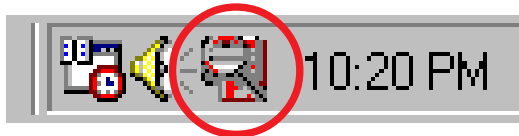

## 6. SOFTWARE REFERENCE

---

(This page was intentionally left blank)



# 6. SOFTWARE REFERENCE

## 6.2 Using YAMAHA XGPlayer

To start the YAMAHA XGPlayer, click **Start**, point to **Programs**, point to **YAMAHA SoftSynthesizer S-YXG50**, and then click **XGPlayer**. You may also right-click the XGPlayer icon on the taskbar to start YAMAHA XGPlayer.

### 6.2.1 YAMAHA XGstudio Player Control Panel



Closes the player. **NOTE:** You can also close the player by pressing <Alt>+<F4>.



Minimizes the player to an icon.



Displays the *Set Play List* dialog box where you can create a list of songs to play automatically. **NOTE:** You can also display the Set Play List dialog box by pressing <Ctrl>+<O>.



Loads and plays the MIDO file currently selected in *Play List*. When all the songs in the Play List have finished, playing stops automatically and the song at the beginning of the list is designated as the current-play song.



Pauses the playing of a song. Click this button again or click  to resume playing.



Stops the playing of a song and returns the start-play location to the beginning of the song.



Designates the first song in the Play List as the new current-play song.



Designates the song just before the currently playing song as the new current-play song.



Designates the song after the song currently playing as the new current-play song.



Designates the last song in the Play List as the new current-play song.



Speeds up the tempo of the song being played.



Slows down the tempo of the song being played.

**NOTE:** The tempo is reset to 0 for each new song.



Displays the *Set Sound Source* dialog box.



Displays Help. **NOTE:** You can also display Help by pressing <F1>.



Increases/decreases the volume level of the song being played by dragging the slider up/down.

# 6. SOFTWARE REFERENCE

## 6.2.2 Troubleshooting

### *Cannot install*

- Do you have the required hardware, such as hard disk and memory?
- Do you have the required software, such as MS-DOS and Windows?
- Installation may not be possible if you have insufficient space on your hard disk. Delete unneeded files to increase the free space on your disk.

### *Does not start*

- Do you have the required hardware, such as hard disk and memory?
- Do you have the required software, such as MS-DOS and Windows?
- Were you able to install using the specified procedure?

### *No sound*

- Is the MIDI driver correctly installed?
- Is the tone generator set correctly?
- Is volume set to zero in the XGstudio Player or XGstudio Mixer panels?
- If you are using an external tone generator, is the serial or MIDI cable and the audio cables connected correctly?
- Are the volumes of your tone generator, audio playback system, and application raised?
- If you have connected an external tone generator via a serial cable, is the rear panel select switch set correctly? (For the name of the select switch, refer to the owner's manual for your external tone generator.)
- If you are using a Soft Synthesizer, is it set so that the computer sound output is heard correctly?

## 6.2.3 About the driver

To use XGPlayer, the driver must be correctly set and selected. The driver you use will differ depending on the type of your tone generator.

If you are using an external MIDI tone generator whose HOST connector is connected to the serial port of your computer, you must install the YAMAHA CBX Driver.

<b>Tone generator used</b>	<b>Driver to select and set</b>
Soft Synthesizer S-YG20	Select the YAMAHA SGMP Driver
Soft Synthesizer S-YG50	Select the YAMAHA SXG50 Driver
External YAMAHA tone generator (MU80 or MU50 etc.)	Select the YAMAHA CBX Driver
External tone generator of another manufacturer	Refer to the owner's manual for your tone generator.

# 6. SOFTWARE REFERENCE

## 6.3 Using YAMAHA XGstudio Mixer

To start the YAMAHA XGstudio, click **Start**, point to **Programs**, point to **YAMAHA XGstudio**, and then click **XGstudio Mixer**.

### 6.3.1 YAMAHA XGstudio Mixer Control Panel

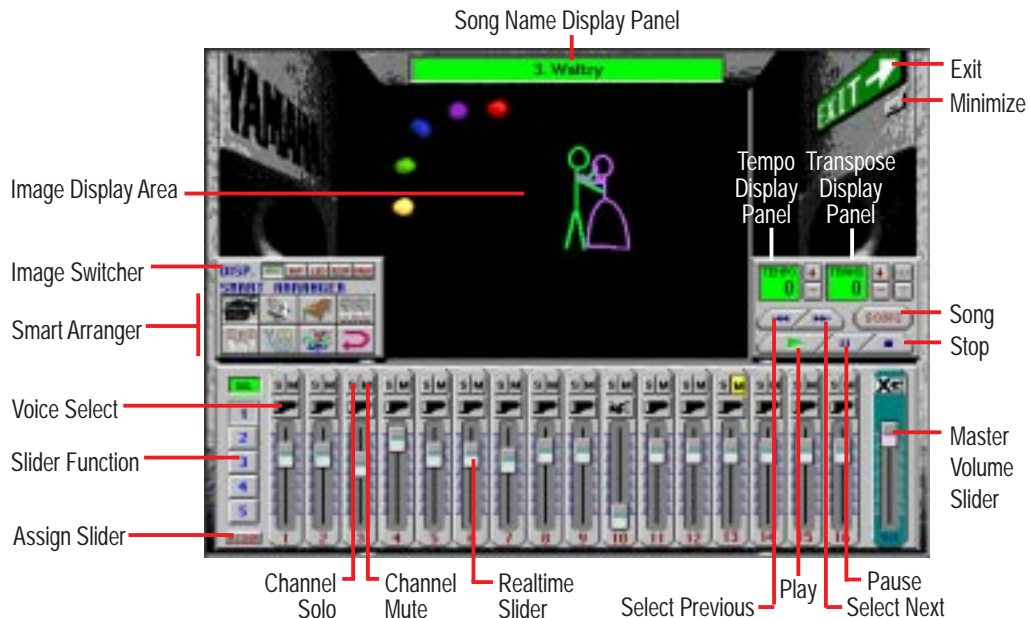

### Image Switcher



#### (AVI file): Video image

Displays the AVI file with the same name as the MIDI file being played. If one is not available, the preset **DEFAULT.AVI** file is played.



#### (BMP file): Still image

Displays the BMP file with the same name as the MIDI file being played. If one is not available, the preset **DEFAULT.BMP** file is played.



#### (LED velocity meter): Animation

Displays the volume (amount of velocity) of each MIDI channel.



#### (SCOPE velocity meter): Animation

Displays the volume (amount of velocity) of each MIDI channel graphically in a radio chart.



#### (drum and percussion): Animation

Displays animation with lights that match the drums and percussion used in the drum channel (10ch).

## 6. SOFTWARE REFERENCE

### Smart Arranger



The Smart Arranger allows you to easily change the mood of a song. You can switch between seven ensemble voice sets with these buttons. To return to the original voice set, click .



### 6.3.2 About the video display screen

If an AVI file (a file containing motion video data) or a BMP file (a file containing still image data) with the same name as the MIDI file is placed in the same folder as the MIDI file, the motion video or still image will be automatically loaded and displayed in the screen when the MIDI file is played.

If there is no AVI file or BMP file with the same name as the MIDI file, the DEFAULT.AVI or DEFAULT.BMP file found in the same folder as CSMIXER.EXT will be displayed. Sample files are included, but you may provide your own favorite AVI file or BMP file. To select a file, click the display screen to bring up the BMP Setup or AVI Setup popup menus.

**NOTE:** The BMP file should not exceed 320 x 240 pixels.

# 7. APPENDIX

## 7.1 ASUS PCI-L101 Fast Ethernet Card

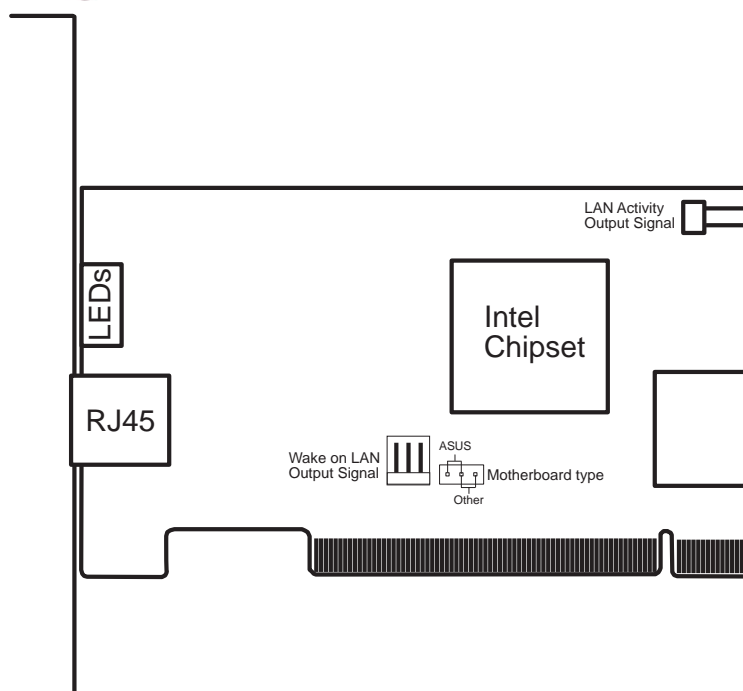
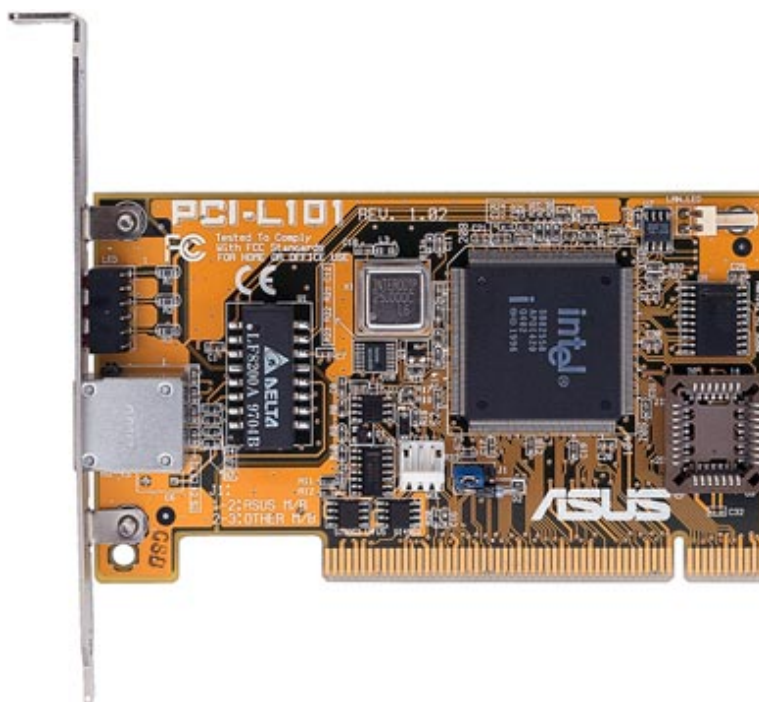

If you are using the ASUS PCI-L101 on this motherboard, leave the jumper on its default setting of “ASUS.” If you are using another brand of motherboard, set the jumper to “Other.” Connect the Wake on LAN (WOL) output signal to the motherboard’s WOL\_CON to utilize the Wake-On-LAN feature of the motherboard. Connect the LAN activity output signal (LAN\_LED) to the system cabinet’s front panel LAN\_LED to display LAN data activity.

7. APPENDIX  
ASUS LAN Card

# 7. APPENDIX

---

## 7.1.1 Features

- Intel 82558 Ethernet LAN Controller (Fully integrated 10BASE-T/100BASE-TX)
- Wake-On-LAN Remote Control Function Supported
- PCI Bus Master Complies with PCI Local Bus Rev. 2.1 specifications
- Consists of MAC & PHY (10/100Mbps) interfaces
- Complies with IEEE 802.3 10BASE-T and IEEE 802.3u 100BASE-TX interfaces
- Fully supports 10BASE-T & 100BASE-TX operations through a single RJ45 port
- Supports 32-bit Bus Master Technology / PCI Rev. 2.1
- Enhancements on ACPI & APM
- Adheres to PCI Bus Power Management Interface Rev. 1.0, ACPI Rev. 1.0, and Device Class Power Management Rev. 1.0
- IEEE 802.3u auto-negotiation for 10Mbps/100Mbps Network Data Transfer Rates.
- Provides LED indicators for monitoring network conditions
- Plug and Play

## 7.1.2 Software Driver Support

- **NetWare ODI Drivers** - Novell Netware 3.x, 4.x, DOS, OS/2 Client
- **NDIS 2.01 Drivers** - Microsoft LAN Manager, Microsoft Windows 3.11, IBM LAN Server
- **NDIS 3.0 Drivers** - Microsoft Windows NT, Microsoft Windows 95, Microsoft Windows 3.11

## 7.1.3 Questions and Answers

Q: What is Wake-On-LAN?

A: The Wake-On-LAN feature provides the capability to remotely power on systems supporting Wake-On-LAN by simply sending a wake-up frame. With this feature, remotely uploading/downloading data to/from systems during off-peak hours will be feasible.

Q: What can Wake-On-LAN do for you?

A: Wake-On-LAN is a remote management tool with advantages that can reduce system management workload, provide flexibility to the system administrator's job, and then of course save you time-consuming efforts and costs.

Q: What components are required for Wake-On-LAN to function?

A: To enable Wake-On-LAN function, your system requires an Ethernet LAN adapter card that can activate Wake-On-LAN function, a client with Wake-On-LAN capability, and software such as LDCM Rev. 3.10 or up that can trigger wake-up frame.

---

(This page was intentionally left blank.)

---

(This page was intentionally left blank.)