

ASUS[®] MEW-L
Socket 370 Intel[®] 810 Motherboard

USER'S MANUAL

USER'S NOTICE

No part of this manual, including the products and software described in it, may be reproduced, transmitted, transcribed, stored in a retrieval system, or translated into any language in any form or by any means, except documentation kept by the purchaser for backup purposes, without the express written permission of ASUSTeK COMPUTER INC. ("ASUS").

ASUS PROVIDES THIS MANUAL "AS IS" WITHOUT WARRANTY OF ANY KIND, EITHER EXPRESS OR IMPLIED, INCLUDING BUT NOT LIMITED TO THE IMPLIED WARRANTIES OR CONDITIONS OF MERCHANTABILITY OR FITNESS FOR A PARTICULAR PURPOSE. IN NO EVENT SHALL ASUS, ITS DIRECTORS, OFFICERS, EMPLOYEES OR AGENTS BE LIABLE FOR ANY INDIRECT, SPECIAL, INCIDENTAL, OR CONSEQUENTIAL DAMAGES (INCLUDING DAMAGES FOR LOSS OF PROFITS, LOSS OF BUSINESS, LOSS OF USE OR DATA, INTERRUPTION OF BUSINESS AND THE LIKE), EVEN IF ASUS HAS BEEN ADVISED OF THE POSSIBILITY OF SUCH DAMAGES ARISING FROM ANY DEFECT OR ERROR IN THIS MANUAL OR PRODUCT.

Product warranty or service will not be extended if: (1) the product is repaired, modified or altered, unless such repair, modification or alteration is authorized in writing by ASUS; or (2) the serial number of the product is defaced or missing.

Products and corporate names appearing in this manual may or may not be registered trademarks or copyrights of their respective companies, and are used only for identification or explanation and to the owners' benefit, without intent to infringe.

- QuickStart and JumperFree are trademarks of ASUSTeK Computer Inc.
- Intel, LANDesk, and Pentium are registered trademarks of Intel Corporation.
- IBM and OS/2 are registered trademarks of International Business Machines.
- Symbios is a registered trademark of Symbios Logic Corporation.
- Windows and MS-DOS are registered trademarks of Microsoft Corporation.
- Adobe and Acrobat are registered trademarks of Adobe Systems Incorporated.

The product name and revision number are both printed on the product itself. Manual revisions are released for each product design represented by the digit before and after the period of the manual revision number. Manual updates are represented by the third digit in the manual revision number.

For previous or updated manuals, BIOS, drivers, or product release information, contact ASUS at <http://www.asus.com.tw> or through any of the means indicated on the following page.

SPECIFICATIONS AND INFORMATION CONTAINED IN THIS MANUAL ARE FURNISHED FOR INFORMATIONAL USE ONLY, AND ARE SUBJECT TO CHANGE AT ANY TIME WITHOUT NOTICE, AND SHOULD NOT BE CONSTRUED AS A COMMITMENT BY ASUS. ASUS ASSUMES NO RESPONSIBILITY OR LIABILITY FOR ANY ERRORS OR INACCURACIES THAT MAY APPEAR IN THIS MANUAL, INCLUDING THE PRODUCTS AND SOFTWARE DESCRIBED IN IT.

Copyright © 1999 ASUSTeK COMPUTER INC. All Rights Reserved.

Product Name:	ASUS MEW-L
Manual Revision:	1.06 E419
Release Date:	July 1999

ASUS CONTACT INFORMATION

ASUSTeK COMPUTER INC. (Asia-Pacific)

Marketing

Address: 150 Li-Te Road, Peitou, Taipei, Taiwan 112
Telephone: +886-2-2894-3447
Fax: +886-2-2894-3449
Email: info@asus.com.tw

Technical Support

Tel (English): +886-2-2894-3447 ext. 706
Tel (Chinese): +886-2-2894-3447 ext. 111
Fax: +886-2-2895-9254
Email: tsd@asus.com.tw
Newsgroup: news2.asus.com.tw
WWW: www.asus.com.tw
FTP: ftp.asus.com.tw/pub/ASUS

ASUS COMPUTER INTERNATIONAL (America)

Marketing

Address: 6737 Mowry Avenue, Mowry Business Center, Building 2
Newark, CA 94560, USA
Fax: +1-510-608-4555
Email: info-usa@asus.com.tw

Technical Support

Fax: +1-510-608-4555
BBS: +1-510-739-3774
Email: tsd-usa@asus.com.tw
WWW: www.asus.com
FTP: ftp.asus.com.tw/pub/ASUS

ASUS COMPUTER GmbH (Europe)

Marketing

Address: Harkort Str. 25, 40880 Ratingen, BRD, Germany
Telephone: 49-2102-445011
Fax: 49-2102-442066
Email: sales@asuscom.de

Technical Support

Hotline: 49-2102-499712
BBS: 49-2102-448690
Email: tsd@asuscom.de
WWW: www.asuscom.de
FTP: ftp.asuscom.de/pub/ASUSCOM

CONTENTS

1. INTRODUCTION	7
1.1 How this manual is organized	7
1.2 Item Checklist	7
2. FEATURES	8
2.1 The ASUS MEW-L Motherboard	8
2.1.1 Specifications	8
2.1.2 Specifications–Optional Components	9
2.1.3 Performance	10
2.1.4 Intelligence	11
2.2 ASUS MEW-L Part Definitions	12
2.3 ASUS MEW-L Part Locations	13
3. HARDWARE SETUP	14
3.1 Motherboard Layout	14
3.2 Layout Contents	15
3.3 Hardware Setup Procedure	17
3.4 Motherboard Settings	17
3.5 System Memory (DIMM)	24
3.5.1 General DIMM Notes	24
3.5.2 DIMM Memory Installation	25
3.6 Central Processing Unit (CPU)	26
3.7 Expansion Cards	27
3.7.1 Expansion Card Installation Procedure	27
3.7.2 Assigning IRQs for Expansion Cards	27
3.7.3 Assigning DMA Channels for ISA Cards	28
3.7.4 Audio Modem Riser (AMR) Slot	28
3.8 External Connectors	29
3.9 Power Connection Procedures	43
4. BIOS SETUP	44
4.1 Managing and Updating Your BIOS	44
4.1.1 Upon First Use of the Computer System	44
4.1.2 Updating BIOS Procedures	45
4.2 BIOS Setup Program	47
4.2.1 BIOS Menu Bar	48
4.2.2 Legend Bar	48
4.3 Main Menu	50
4.3.1 Primary & Secondary Master/Slave	51
4.4 Advanced Menu	56
4.4.1 Chip Configuration	58
4.4.2 I/O Device Configuration	61
4.4.3 PCI Configuration	63
4.4.4 Shadow Configuration	66

CONTENTS

4.5	Power Menu	67
4.5.1	Power Up Control	69
4.5.2	Hardware Monitor	71
4.6	Boot Menu	72
4.7	Exit Menu	74
5.	SOFTWARE SETUP	77
	ASUS Smart Motherboard Support CD	77
	Software Setup Contents	78
	Support CD Content Descriptions	79
	Operating Systems	81
5.1	Intel LANDesk Client Manager (LDCM)	82
5.2	ASUS PC Probe	83
5.3	ASUS Update	84
5.4	Driver	85
5.4.1	Network Driver Setup (LAN model only)	85
5.4.2	VGA Driver Setup	86
5.4.3	Audio Driver Setup (audio model only)	87
5.5	Other	88
5.5.2	INF Update Utility for 810 Chipset	88
5.5.3	Intel Security Controller Driver	89
5.5.4	YAMAHA S-YXG50	90
5.5.5	Microsoft DirectX 6.0 Driver	91
5.5.6	PC-cillin 98 V4.06	92
5.5.7	Adobe Acrobat Reader V4.0	93
5.6	ASUS DMI Utility	94
5.7	Flash BIOS Utility (DOS)	95
5.8	Uninstalling Programs	96
6.	SOFTWARE REFERENCE	97
6.1	ASUS PC Probe	99
6.2	ASUS Update	105
6.3	Display Properties	107
6.4	YAMAHA S-YXG50	111
6.5	Desktop Management Interface (DMI)	113
6.6	Hardware Information	116
7.	APPENDIX	117
7.1	Glossary	117

FCC & DOC COMPLIANCE

Federal Communications Commission Statement

This device complies with FCC Rules Part 15. Operation is subject to the following two conditions:

- This device may not cause harmful interference, and
- This device must accept any interference received, including interference that may cause undesired operation.

This equipment has been tested and found to comply with the limits for a Class B digital device, pursuant to Part 15 of the FCC Rules. These limits are designed to provide reasonable protection against harmful interference in a residential installation. This equipment generates, uses and can radiate radio frequency energy and, if not installed and used in accordance with manufacturer's instructions, may cause harmful interference to radio communications. However, there is no guarantee that interference will not occur in a particular installation. If this equipment does cause harmful interference to radio or television reception, which can be determined by turning the equipment off and on, the user is encouraged to try to correct the interference by one or more of the following measures:

- Re-orient or relocate the receiving antenna.
- Increase the separation between the equipment and receiver.
- Connect the equipment to an outlet on a circuit different from that to which the receiver is connected.
- Consult the dealer or an experienced radio/TV technician for help.

WARNING! Any changes or modifications to this product not expressly approved by the manufacturer could void any assurances of safety or performance and could result in violation of Part 15 of the FCC Rules.

Reprinted from the Code of Federal Regulations #47, part 15.193, 1993. Washington DC: Office of the Federal Register, National Archives and Records Administration, U.S. Government Printing Office.

Canadian Department of Communications Statement

This digital apparatus does not exceed the Class B limits for radio noise emissions from digital apparatus set out in the Radio Interference Regulations of the Canadian Department of Communications.

This Class B digital apparatus complies with Canadian ICES-003.

Cet appareil numérique de la classe B est conforme à la norme NMB-003 du Canada.

1. INTRODUCTION

1.1 How this manual is organized

This manual is divided into the following sections:

- | | |
|-----------------------|--|
| 1) INTRODUCTION | Manual information and checklist |
| 2) FEATURES | Product information and specifications |
| 3) HARDWARE SETUP | Instructions on setting up the motherboard |
| 4) BIOS SETUP | Instructions on setting up the BIOS software |
| 5) SOFTWARE SETUP | Instructions on setting up the included software |
| 6) SOFTWARE REFERENCE | Reference material for the included software |
| 7) APPENDIX | Optional items and general reference |

1.2 Item Checklist

Check that your package is complete. If you discover damaged or missing items, please contact your retailer.

- (1) ASUS Motherboard
- (1) 40-pin ribbon cable for internal UltraDMA/33 IDE drives
- (1) 80-wire ribbon cable for internal UltraDMA/66 or UltraDMA/33 IDE drives
(Note: The 80-wire ribbon cable is designed with a 40-pin connector.)
- (1) Ribbon cable for (1) 5.25" and (2) 3.5" floppy drives
- (1) Bag of spare jumper caps
- (1) Support CD with drivers and utilities
- (1) This Motherboard User's Manual

- I/O Shield (for LAN model only; metallic plate which replaces the chassis' provided standard ATX connector shield)
- Serial COM2 connector with bracket (for non-LCD model only)
- LCD panel & Serial COM2 connector with bracket (for LCD model only)
- ASUS IrDA-compliant Infrared module (optional)
- ASUS Consumer Infrared set (optional)

2. FEATURES

2.1 The ASUS MEW-L Motherboard

The MEW-L motherboard from ASUS is carefully designed for the demanding PC user who wants many smart features in a small package. So what's so smart about the ASUS MEW-L motherboard?

2.1.1 Specifications

- **Latest Intel Socket 370 Processor Support!** Supports Intel's Celeron processor designed for Socket 370 and packaged in **Plastic Pin Grid Array (PPGA)**.
- **Latest Intel 810 Chipset!** Features 100MHz FSB Intel 810 chipset (GMCH0 & ICH) and a 24-bit 230MHz RAMDAC graphics controller.
- **Integrated Graphics!** Controller supports 3D hyper pipelined architecture, parallel data processing and compression, precise pixel interpolation, full 2D hardware acceleration, and motion video acceleration.
- **ASUS Graphics Driver!** You can gain about 12% performance over that of the standard graphics driver (2D highend graphics WinMark) using ASUS' custom graphics driver. ASUS custom graphics driver also provides more features and provides selection of higher refresh rates and resolutions.
- **Versatile Memory Support!** DRAM controller supports asymmetrical addressing and three DIMM sockets support Intel PC100-compliant SDRAMs (16, 32, 64, 128, or 256MB) up to 512MB. (supports a maximum of 4 sides)
- **JumperFree™ Mode!** Allows processor settings and easy overclocking of frequency and Vcore voltage all through BIOS setup when JumperFree™ mode is enabled. Easy-to-use DIP switches instead of jumpers are included in case you want to manually adjust the processor's external frequency.
- **Smart Slots!** Optional five 32-bit PCI (rev 2.2) with two 16-bit ISA expansion slots, 6 PCI with 1 ISA, or 6 PCI with no ISA. PCI supports up to 133MB/sec maximum throughput. Each PCI slot can support a Bus Master PCI card (such as SCSI or LAN cards).
- **Latest Low Pin Count Multi-I/O:** Provides two high-speed UART compatible serial ports and one parallel port with EPP and ECP capabilities.
- **Integrated IDE!** Controller supports UltraDMA/66 up to 66MB/s, UltraDMA/33 up to 33MB/s, and PIO Mode 4 up to 17MB/s.
- **Desktop Management Interface (DMI) V2.3!** Supports DMI through BIOS, which allows hardware to communicate within a standard protocol creating a higher level of compatibility. (Requires DMI-enabled components.)
- **Peripheral Wake-Up!** Supports Wake-On-LAN, Wake-On-Ring, Keyboard Wake-Up, BIOS Wake-Up, and wake-up by infrared remote control.
- **AMR Slot!** Audio Modem Riser slot supports a very affordable audio and/or modem riser card.

2. FEATURES

- **Around-the-Clock Intrusion Detection!** Chassis intrusion circuitry can log chassis panel open events into LDCM (available in near future for this motherboard). The onboard battery supports detection even when normal power is removed and through a new design, battery drain is even lower than the RTC used for keeping time!
- **Firmware Hub!** Provides security and other latest power computing features.
- **Monitoring for your PC's Health!** Provided ASUS PC Probe or Intel LDCM (this motherboard requires v6.0 available in the near future) allows PC health monitoring.
- **Enhanced ACPI & Anti-Boot Virus Protection!** Programmable BIOS (Flash EEPROM), offering enhanced ACPI for Windows 98 compatibility, built-in firmware-based virus protection, and autodetection of most devices for virtually automatic setup.
- **Smart BIOS!** 4Mb firmware gives a new easy-to-use interface which provides more control and protection over the motherboard. Provides Vcore and CPU/SDRAM frequency adjustments, boot block write protection, and HD/SCSI/MO/ZIP/CD/Floppy boot selection. Hardware random number generator supports new security software for data protection and secured Internet transactions.
- **Wired for Management (WfM) V2.0!** Supports remote monitor, diagnosis, and management (Alert-On-LAN) in network configuration.

2.1.2 Specifications—Optional Components

The following onboard components are optional at the time of purchase:

- **Smart Audio!** Software Audio and Hardware AC'97 V2.1 CODEC compliant, Analog Device's 3D sound circuitry, sample rate conversion from 7kHz to 48kHz. Full amplified audio output can be directed to the chassis' internal speaker in order to save space, save money, and reduce complications associated with external speakers. Chassis speaker volume can be digitally controlled through OS.
- **3D Positional Audio!** Brings new levels of realism to games with sounds being positioned interactively around the user, making them truly part of the 3D virtual experience. Better music reproduction is possible with MIDI utilizing Wavetable synthesis.
- **Smart Networking!** Features the Intel 82559 Fast-Ethernet LAN Controller (fully integrated 10BASE-T/100BASE-TX). Supports TCO function.
- **Space Savings!** Digital Flat Panel (DFP) Interface gives a direct digital connection for connecting a **digital** flat panel (analog flat panel must be connected to the VGA-out connector) to your PC. This interface transmits sharp, bright images by eliminating digital-to-analog and analog-to-digital conversions, which can accumulate noise and degrade image quality.
- **No Messy Wires!** Integrated consumer IR and Standard IR supports an optional remote control package for wireless interfacing with external peripherals, personal gadgets, or an optional remote controller.

2. FEATURES

2.1.3 Performance

- **UltraPerformance!** Onboard IDE Bus Master controller with two connectors that support four IDE devices in two channels. Supports UltraDMA/66, UltraDMA/33 (IDE DMA Mode 2), PIO Modes 3 & 4, and supports Enhanced IDE devices, such as Tape Backup, CD-ROM, CD-R/RW, and LS-120 drives.
- **Dual Speeds!** CPU frequency can operate at either 66MHz or 100MHz while system memory operates at either 100MHz or 66MHz. (100MHz CPU with 66MHz SDRAM setting not supported) This asynchronous design can optimize the VGA performance under shared memory configuration. Of course 100MHz/100MHz synchronous host/DRAM clock is recommended for maximum performance.
- **Double or Quadruple the IDE Transfer Speed!** IDE transfers using UltraDMA/33 Bus Master IDE can handle rates up to 33MB/s and up to 66MB/s using UltraDMA/66 technology. The best of all is that these new technology is compatible with existing ATA-2 IDE specifications so there is no need to upgrade current IDE devices or cables.
- **Concurrent PCI!** Concurrent PCI allows multiple PCI transfers from PCI master buses to memory to CPU.
- **SDRAM Optimized Performance!** ASUS smart series motherboards support the new generation memory, Synchronous Dynamic Random Access Memory (SDRAM), which increases the data transfer rate to 800MB/s max using PC100 SDRAM.
- **ACPI Ready!** ACPI (Advanced Configuration and Power Interface) is also implemented on all ASUS smart series motherboards. ACPI provides more Energy Saving Features for future operating systems (OS) supporting OS Direct Power Management (OSPM) functionality. With these features implemented in the OS, PCs can be ready around the clock, yet satisfy all the energy saving standards. To fully utilize the benefits of ACPI, an ACPI-supported OS such as Windows 98 must be used.
- **Suspend and Go!** Suspend-to-RAM (STR) provides maximum power savings as an alternative to leaving the computer ON and QuickStart™ so that you do not fall asleep waiting for system bootup. (STR requires OS support and does not support ISA cards; ISA cards may fail to work coming out of STR mode.)
- **New Comliancy!** Both the BIOS and hardware levels of the motherboard meet PC'99 compliancy (on model without ISA). The new PC'99 requirements for systems and components are based on the following high-level goals: Support for Plug and Play compatibility and power management for configuring and managing all system components, and 32-bit device drivers and installation procedures for Windows 95/98/NT. Color-coded connectors and descriptive icons make identification easy as required by PC'99.
- **Highest Audio Quality!** AC'97 DAC/ADC built into the audio CODEC reduces noise to improve audio quality and performance for a SNR (signal to noise ratio) of +90dB. These features greatly improve voice synthesis and recognition.
- **Extreme Graphics!** The integrated motion compensation allows for smooth MPEG1 or MPEG2 video playback. Fast 3D graphics engine allows for an exciting gameplay experience.

2. FEATURES

2.1.4 Intelligence

- **Fan Status Monitoring and Alarm!** To prevent system overheat and system damage, the CPU, power supply, and system fans can be monitored for RPM and failure. All the fans are set for its normal RPM range and alarm thresholds.
- **Temperature Monitoring and Alert!** To prevent system overheat and system damage, this motherboard supports Socket 370 processor thermal sensing and auto-protection.
- **Voltage Monitoring and Alert!** System voltage levels are monitored to ensure stable current to critical motherboard components. Voltage specifications are more critical for future processors, so monitoring is necessary to ensure proper system configuration and management.
- **System Resources Alert!** (Requires the future release of LDCM v6.0) Today's operating systems such as Windows 98, Windows NT, and OS/2, require much more memory and hard drive space to present enormous user interfaces and run large applications. The system resource monitor will warn the user before the system resources are used up to prevent possible application crashes. Suggestions will give the user information on managing their limited resources more efficiently.
- **Dual Function Power Button!** Through BIOS, the power button can be defined as the "Stand by" (a.k.a. Suspend or Sleep) button or as the Soft-Off (see ATX Power Switch for more information) button. Regardless of the setting, pushing the power button for more than 4 seconds will enter the Soft-Off mode.
- **Remote Ring On (requires modem)!** This allows a computer to be turned on remotely through an internal or external modem. With this benefit on-hand, users can access any information from their computers from anywhere in the world!
- **Message LED (requires ACPI OS support)!** Chassis LEDs now act as information providers. Through the way a particular LED illuminates, the user can determine the stage the computer is in. A simple glimpse provides useful information to the user.
- **Peripheral Power Up!** Keyboard or Mouse power up can be enabled or disabled through BIOS setup to allow the computer to be powered ON using your keyboard or mouse click.

2. FEATURES

2.2 ASUS MEW-L Part Definitions

The following are part descriptions for the motherboard parts shown on the next page.

- 1 ATX Power Connector for connection to an ATX power supply
- 2 LCD Header for LCD connector set (LCD model only)
- 3 LCD Chipset (on LCD model only)
- 4 Socket 370 for Intel Celeron 370 processors
- 5 Intel 810 (GMCH0+ICH) Integrated Graphics Chipset
- 6 Three DIMM Sockets
- 7 Primary and Secondary IDE Connectors
- 8 Feature Setting DIP Switches
- 9 Floppy Disk Drive Connector
- 10 Serial COM2 Header
- 11 Intel I/O Controller Hub (ICH)
- 12 Low Pin Count Multi-I/O Chipset
- 13 Four Mbit Firmware Hub (programmable BIOS)
- 14 Wake-On-Ring Connector
- 15 Wake-On-LAN Connector
- 16 One or Two ISA Slot(s) (on ISA model only)
- 17 PCI to ISA Bridge (on ISA model only)
- 18 Intel 82559 Fast-Ethernet Chipset (on LAN model only)
- 19 AC'97 V2.1 Audio CODEC
- 20 Five or Six PCI Slots (optional at the time of purchase)
- 21 Audio Modem Riser (AMR) Connector
- 22 Joystick, Midi, Line Out, Line In, Microphone In Connectors
- 23 VGA Monitor Output Connector
- 24 Parallel Connector
- 25 Serial COM1 Connector
- 26 LAN (RJ45) and USB Connectors (LAN optional)
- 27 PS/2 Mouse, PS/2 Keyboard Connectors

2. FEATURES

2.3 ASUS MEW-L Part Locations

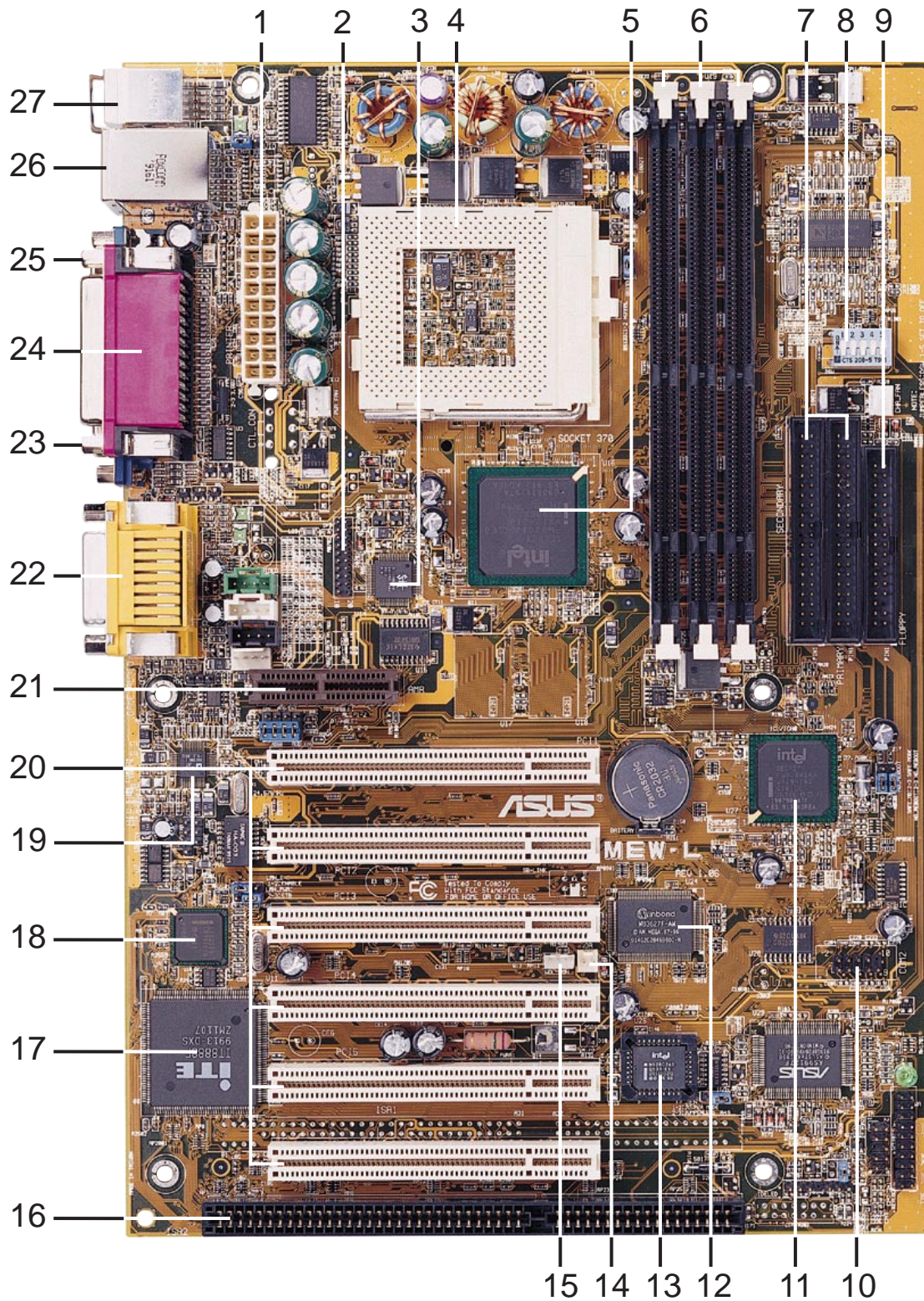

2. FEATURES
Part Locations

NOTE: The ISA model is shown above. One or two ISA slots are optional at the time of purchase. The model with two ISA will have only 5 PCI slots.

3. HARDWARE SETUP

3.1 Motherboard Layout

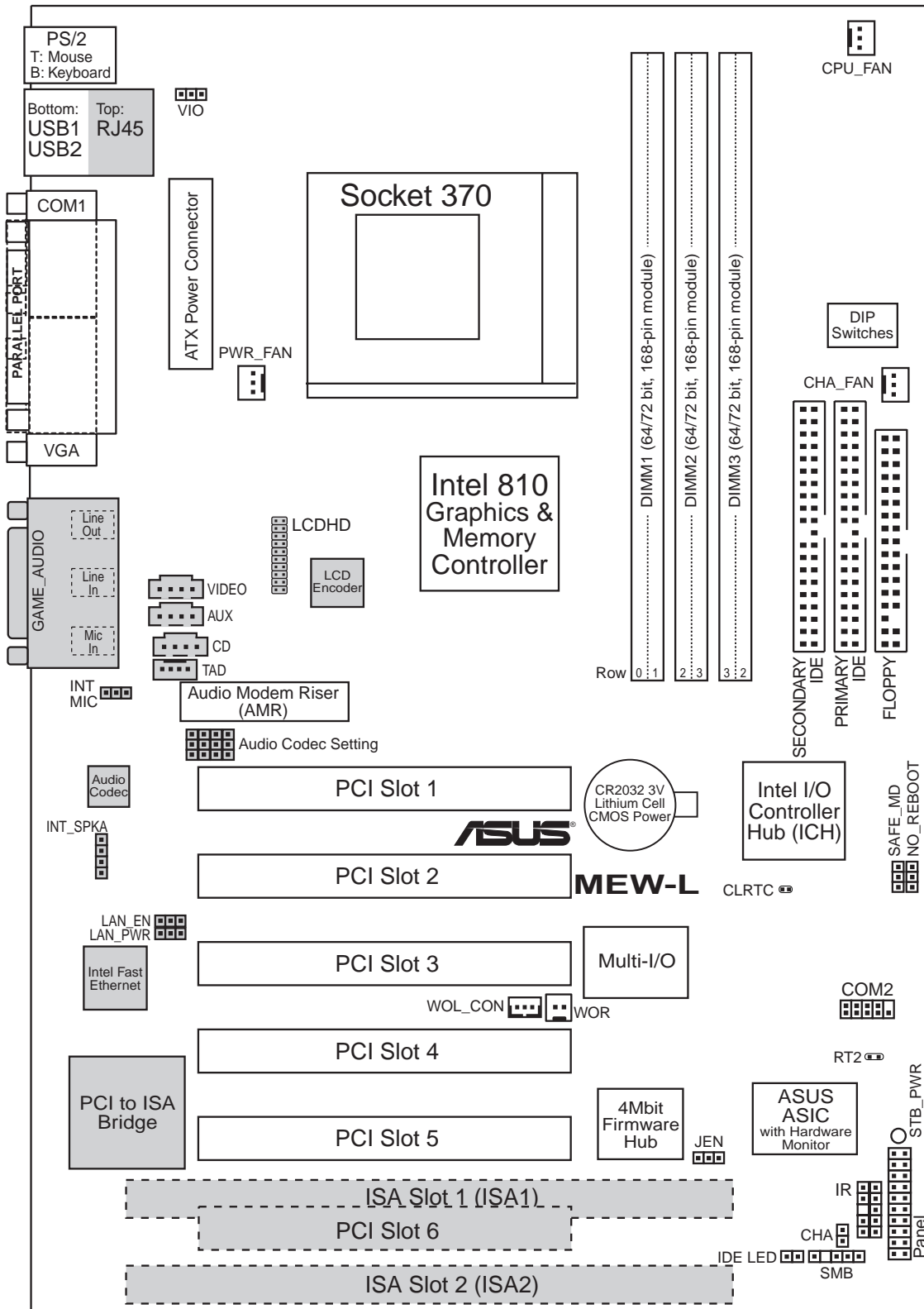

(Grayed items are optional at the time of purchase.)

3. HW SETUP
Motherboard Layout

3. HARDWARE SETUP

3.2 Layout Contents

Motherboard Settings

- | | |
|----------------|---|
| 1) JEN | p.18 JumperFree™ Mode (Enable/Disable) |
| 2) VIO | p.19 Voltage I/O Setting (Normal/+3.66V) |
| 3) AUDIO CODEC | p.19 Onboard Audio Setting (Enable/Disable) |
| 4) LAN_EN | p.20 Onboard LAN Setting (Enable/Disable) |
| 5) LAN_PWR | p.20 Onboard LAN Power Setting (Normal/Standby) |
| 6) SAFE_MD | p.21 Safe Mode (Enable/Disable) |
| 7) NO_REBOOT | p.21 Automatic Timeout Reboot (Enable/Disable) |
| 8) DSW | p.22 CPU External Clock (BUS) Frequency Setting |

Expansion Slots

- | | |
|---------------------------------|---|
| 1) DIMM1, DIMM2, DIMM3 | p.23 168-Pin DIMM Memory Support |
| 2) Socket 370 | p.25 Central Processing Unit (CPU) Socket |
| 3) ISA1, ISA2 | p.26 16-bit ISA Bus Expansion Slots (optional) |
| 4) PCI1, PCI2, PCI3, PCI4, PCI5 | p.26 32-bit PCI Bus Expansion Slots (optional PCI6) |
| 5) AMR | p.28 Audio Modem Riser Slot |

Connectors

- | | |
|---------------------------|--|
| 1) PS2KBMS | p.29 PS/2 Mouse Connector (6-pin female) |
| 2) PS2KBMS | p.29 PS/2 Keyboard Connector (6-pin female) |
| 3) USB | p.30 Universal Serial Bus Ports 1 & 2 (Two 4-pin female) |
| 4) PRINTER | p.30 Parallel Port Connector (25-pin female) |
| 5) COM1 | p.30 Serial Port COM1 Connector (9-pin male) |
| 6) VGA | p.31 Monitor (VGA) Output Connector (15-pin female) |
| 7) GAME_AUDIO | p.31 Joystick/MIDI Connector (15-pin female) (optional) |
| 8) GAME_AUDIO | p.31 Audio Port Connectors (Three 1/8" female) (optional) |
| 9) RJ45 | p.31 Fast-Ethernet Port Connector (RJ45) (optional) |
| 10) PRIMARY/SECONDARY IDE | p.32 Primary/Secondary IDE Connectors (Two 40-1pins) |
| 11) FLOPPY | p.32 Floppy Disk Drive Connector (34-1pins) |
| 12) WOL_CON | p.33 Wake-On-LAN Connector (3 pins) |
| 13) WOR | p.33 Wake-On-Ring Connector (2 pins) |
| 14) IDE LED | p.34 IDE Activity LED (2 pins) |
| 15) CHA_, CPU_, PWR_FAN | p.34 Chassis, CPU, Power Supply Fan Connectors (Three 3-pin) |
| 16) VIDEO, AUX, CD, TAD | p.35 Internal Audio Connectors (Four 4-pins) (optional) |
| 17) INT_SPKA | p.35 Internal Speaker Connectors (4-pins) (optional) |
| 18) IR (CIR/SIR) | p.36 Infrared Module Connector (10-1 pins) |
| 19) COM2 | p.36 Serial Port COM2 Header (10-1 pins) |

3. HARDWARE SETUP

20) SMB	p.37 SMBus Connector (5-1 pins)
21) LCDHD	p.37 Digital LCD Header (20 pins) (optional)
22) INT MIC	p.38 Internal Microphone Connector (3 pins)
23) CHA	p.39 Chassis Intrusion Connector (2 pins)
24) ATXPWR	p.39 ATX Power Supply Connector (20 pins)
25) SPEAKER (PANEL)	p.41 System Warning Speaker Connector (4 pins)
26) KEYLOCK (PANEL)	p.41 Keyboard Lock Switch Lead (2 pins)
27) PLED (PANEL)	p.41 System Power LED Lead (3-1 pins)
28) RESET (PANEL)	p.41 Reset Switch Lead (2 pins)
29) PWRSW (PANEL)	p.41 ATX Power / Soft-Off Switch Lead (2 pins)
30) SMI (PANEL)	p.41 System Management Interrupt Switch Lead (2 pins)
31) LED (PANEL)	p.41 System Message LED (2 pins)

3. HARDWARE SETUP

3.3 Hardware Setup Procedure

Before using your computer, you must complete the following steps:

- **Check Motherboard Settings**
- **Install Memory Modules**
- **Install the Central Processing Unit (CPU)**
- **Install Expansion Cards**
- **Connect Ribbon Cables, Panel Wires, and Power Supply**

3.4 Motherboard Settings

This section explains in detail how to change your motherboard's function settings through the use of switches and/or jumpers.

WARNING! Computer motherboards and expansion cards contain very delicate Integrated Circuit (IC) chips. To protect them against damage from static electricity, you should follow some precautions whenever you work on your computer.

1. Unplug your computer when working on the inside.
2. Use a grounded wrist strap before handling computer components. If you do not have one, touch both of your hands to a safely grounded object or to a metal object, such as the power supply case.
3. Hold components by the edges and try not to touch the IC chips, leads or connectors, or other components.
4. Place components on a grounded antistatic pad or on the bag that came with the component whenever the components are separated from the system.

Motherboard Feature Settings (DSW)

Besides jumper settings, some of the motherboard's onboard functions are adjusted through the DIP switches. The white block represents the switch's position. The example below shows all the switches in the OFF position.

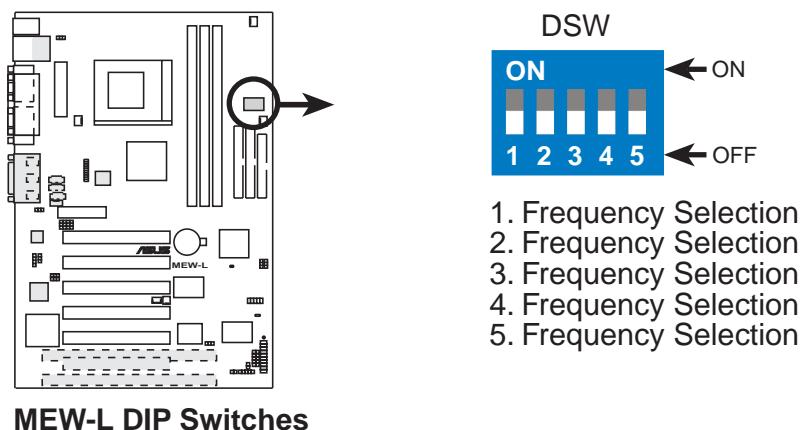

3. HARDWARE SETUP

1) JumperFree™ Mode (JEN)

This jumper allows you to enable or disable the JumperFree™ mode. The JumperFree™ mode allows processor settings to be made through the BIOS setup (see *4.4 Advanced Menu*).

NOTE: In JumperFree™ mode, all dip switches (DSW) must be set to OFF.

<u>Setting</u>	<u>JEN</u>
Disable (Jumper)	[1-2] (default)
Enable (JumperFree)	[2-3]

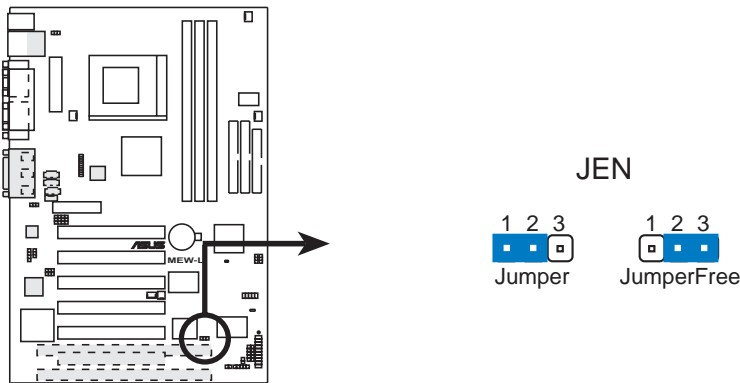

MEW-L JumperFree™ Mode Setting

3. HARDWARE SETUP

2) Voltage I/O Setting (VIO)

This jumper allows you to select the voltage supplied to the DRAM, chipset, PCI, and the CPU's I/O buffer. The default voltage should be used unless processor overclocking requires a higher voltage.

Setting	VIO
Normal	[1-2] (default)
3.66V	[2-3]

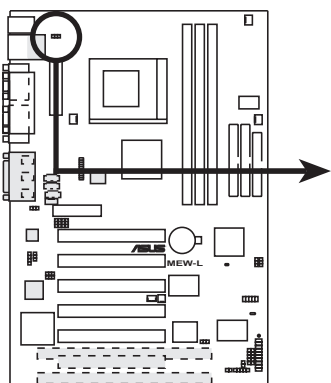

MEW-L VIO Setting

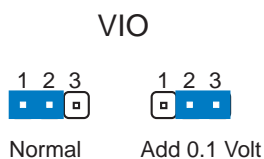

WARNING! Using a higher voltage may help when overclocking but may result in the shortening of your computer component's life. It is strongly recommended that you leave this setting on its default.

3) Onboard Audio Setting (available on audio model only)

The onboard audio CODEC may be enabled or disabled using all of these jumpers. Disable the onboard audio CODEC if you are using an ISA or PCI audio card on any of the expansion slots or a primary AMR on the AMR slot (see AMR Slot later in this section). If using an ISA or PCI audio expansion card, **Onboard AC'97 Audio Controller** in **4.2 I/O Device Configuration** must also be disabled.

Setting	AUDIO CODEC
Enable	[1-2] [1-2] [1-2] [1-2]
Disable	[2-3] [2-3] [2-3] [2-3]

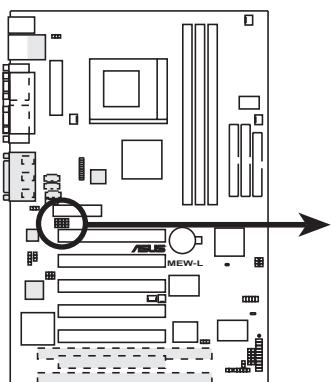

MEW-L Audio Codec Setting

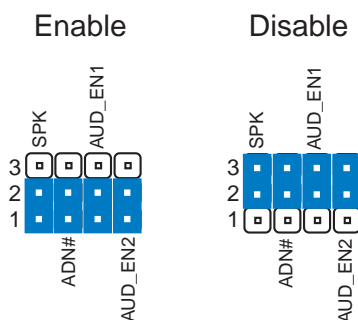

3. HARDWARE SETUP

- 4) **Onboard LAN Setting (LAN_EN) available on LAN model only**
The onboard LAN may be enabled or disabled by this jumper.

Setting	LAN_EN
Enable	[1-2] (default)
Disable	[2-3]

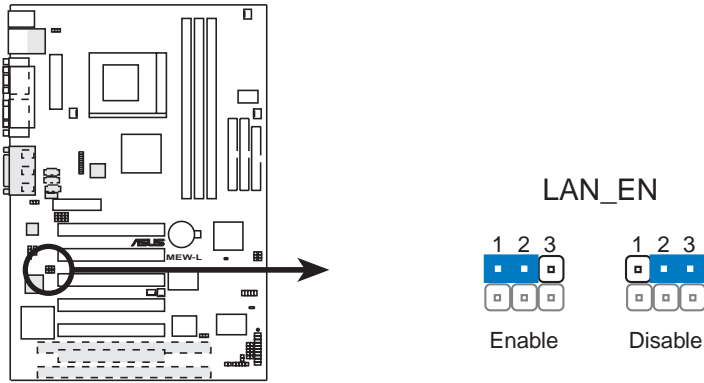

MEW-L LAN Setting

- 5) **Onboard LAN Power Setting (LAN_PWR) available on LAN model only**
The onboard LAN power may be set to normal or standby power. Select **Normal** if you do not have a power supply with 720mA standby power. Selecting **Standby** will allow the use of Wake-On-LAN but may not allow system bootup if the power supply's standby power is insufficient.

Setting	LAN_PWR
Normal	[1-2] (default)
Standby	[2-3]

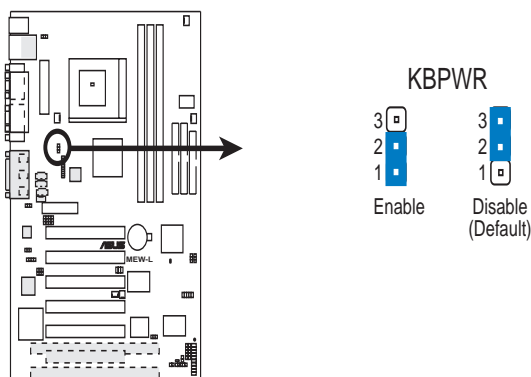

MEW-L Keyboard Power Up

3. HARDWARE SETUP

6) Safe Mode (SAFE_MD)

Usually socket 370 processors have locked frequency multiples. In this case, there is no way to exceed the specified multiple whether through motherboard settings or BIOS setup. With unlocked socket 370 processors, exceeding the specified multiple is possible through BIOS setup. Exceeding the specified multiple may result in hanging during bootup. If this occurs, enable Safe Mode to force a multiple of 2 in order to enter BIOS setup to correct the problem.

<u>Setting</u>	<u>SAFE MD</u>
Disable	[1-2] (default)
Enable	[2-3]

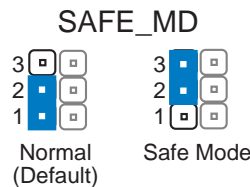
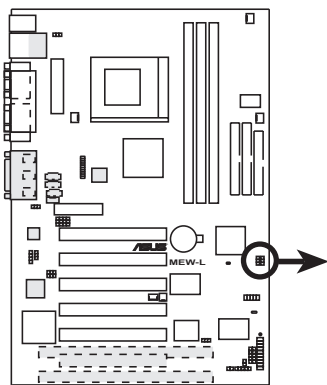

MEW-L Safe Mode Setting

7) Automatic Timeout Reboot Setting (NO_REBOOT)

The motherboard is set so that when the BIOS detects a hang (timeout) during bootup, the motherboard will automatically reboot in order to try rebooting again. If rebooting is repeating ineffectively, set this jumper to “No Reboot” so that auto-reboot will be disabled.

<u>Setting</u>	<u>NO REBOOT</u>
Normal	[1-2] (default)
No Reboot	[2-3]

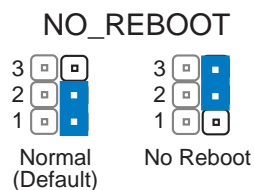
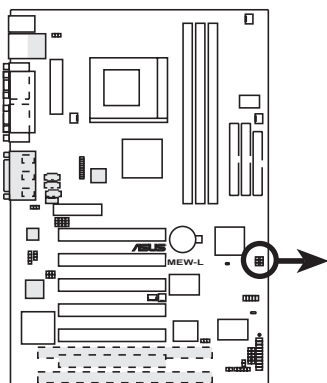

MEW-L Reboot Setting

3. HARDWARE SETUP

8) CPU External Frequency Setting (DSW)

This option tells the clock generator what frequency to send to the CPU, DRAM, and the PCI bus. This allows the selection of the CPU's *External* frequency. The CPU External Frequency multiplied by the Frequency Multiple equals the CPU's *Internal* frequency (the advertised CPU speed). **NOTE:** You may set the memory speed independently from the CPU External Frequency. Depending on your memory type PC66 (66MHz) or PC100 (100MHz), select the appropriate "SDRAM" speed along with the appropriate "CPU" speed.

IMPORTANT: Only 66MHz CPU and 100MHz SDRAM should be used on this motherboard with current 66MHz Socket 370 processors. Other settings are for experienced users only. When JumperFree mode is enabled, use BIOS setup in place of these switches (see **CPU Speed** in *4.4 Advanced Menu*). Only selected switches are illustrated, see the next page for a complete frequency listing. **NOTE:** In JumperFree mode, all dip switches (DSW) must be set to OFF.

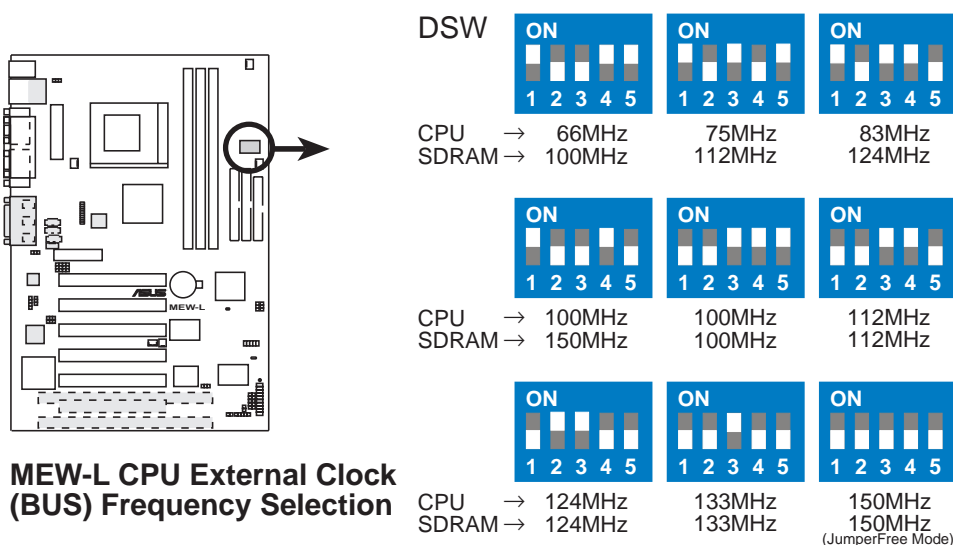

NOTE: Frequency Multiple settings are not available here because usually Socket 370 processors have locked Frequency Multiples. If your Socket 370 processor does not have a locked Frequency Multiple, you must use **CPU Core:Bus Freq. Multiple** in *4.4 Advanced Menu* of the BIOS setup to set the Frequency Multiple. If the Frequency Multiple is locked, setting the Frequency Multiple in BIOS setup will have no effect.

WARNING! CPU frequencies above 66MHz exceed the specifications for current Celeron processors and are not guaranteed to be stable. Premature wearing of the processor may result when overclocking. Be sure that the DIMM you use can handle the specified SDRAM MHz or else bootup will not be possible.

3. HARDWARE SETUP

External Frequency Table for Intel Celeron (PPGA) Processors

The following table is for use by experienced motherboard installers only. Overclocking can result in system instability or even shortening the life of the processor. Bold settings are also shown on the previous page.

CPU (MHz)	SDRAM (MHz)	PCI (MHz)	Frequency Selection Switches				
			1	2	3	4	5
67.81	101.71	33.90	[ON]	[ON]	[ON]	[ON]	[ON]
70.00	105.00	35.00	[ON]	[OFF]	[ON]	[ON]	[ON]
72.01	108.01	36.00	[ON]	[ON]	[OFF]	[ON]	[ON]
66.67	100.00	33.33	[ON]	[OFF]	[OFF]	[ON]	[ON]
73.01	109.51	36.50	[ON]	[ON]	[ON]	[OFF]	[ON]
75.00	112.50	37.50	[ON]	[OFF]	[ON]	[OFF]	[ON]
77.00	115.50	38.50	[ON]	[ON]	[OFF]	[OFF]	[ON]
78.01	117.01	39.00	[ON]	[OFF]	[OFF]	[OFF]	[ON]
80.00	120.00	40.00	[ON]	[ON]	[ON]	[ON]	[OFF]
83.00	124.51	41.50	[ON]	[OFF]	[ON]	[ON]	[OFF]
84.49	126.74	42.25	[ON]	[ON]	[OFF]	[ON]	[OFF]
100.00	150.00	50.00	[ON]	[OFF]	[OFF]	[ON]	[OFF]
86.08	129.12	43.04	[ON]	[ON]	[ON]	[OFF]	[OFF]
88.00	132.00	44.00	[ON]	[OFF]	[ON]	[OFF]	[OFF]
90.00	135.00	45.00	[ON]	[ON]	[OFF]	[OFF]	[OFF]
95.00	142.50	47.50	[ON]	[OFF]	[OFF]	[OFF]	[OFF]
49.90	49.90	16.63	[OFF]	[ON]	[ON]	[ON]	[ON]
100.00	100.00	33.33	[OFF]	[OFF]	[ON]	[ON]	[ON]
74.85	74.85	24.95	[OFF]	[ON]	[OFF]	[ON]	[ON]
66.58	66.58	22.19	[OFF]	[OFF]	[OFF]	[ON]	[ON]
82.84	82.84	27.61	[OFF]	[ON]	[ON]	[OFF]	[ON]
89.81	89.81	29.93	[OFF]	[OFF]	[ON]	[OFF]	[ON]
94.80	94.80	31.60	[OFF]	[ON]	[OFF]	[OFF]	[ON]
100.50	100.50	33.50	[OFF]	[OFF]	[OFF]	[OFF]	[ON]
104.78	104.78	34.93	[OFF]	[ON]	[ON]	[ON]	[OFF]
111.77	111.77	37.26	[OFF]	[OFF]	[ON]	[ON]	[OFF]
114.77	114.77	38.26	[OFF]	[ON]	[OFF]	[ON]	[OFF]
100.00	100.00	33.33	[OFF]	[OFF]	[OFF]	[ON]	[OFF]
123.75	123.75	41.25	[OFF]	[ON]	[ON]	[OFF]	[OFF]
132.74	132.74	44.25	[OFF]	[OFF]	[ON]	[OFF]	[OFF]
139.75	139.75	46.58	[OFF]	[ON]	[OFF]	[OFF]	[OFF]
149.69	149.69	49.90	[OFF]	[OFF]	[OFF]	[OFF]	[OFF]

NOTE: The PCI clock is equal to 1/3 the speed of the SDRAM. PCI's specification allows for up to 33MHz, therefore using PC100-compliant DIMM and setting SDRAM to about 100MHz is recommended. For updated processor settings, please visit ASUS' web site (see ASUS CONTACT INFORMATION)

3. HARDWARE SETUP

3.5 System Memory (DIMM)

NOTE: No hardware or BIOS setup is required after adding or removing memory.

This motherboard uses only Dual Inline Memory Modules (DIMMs). Sockets are available for **3.3Volt** (power level) unbuffered Synchronous Dynamic Random Access Memory (SDRAM) of 16, 32, 64, 128MB, or 256MB.

This chipset does not support ECC. However, ECC memory modules may still be used, but the ECC function will not be available.

Memory speed setup is recommended through **SDRAM Configuration** in **4.4.1 Chip Configuration**.

Install memory in any combination as follows:

Location	168-pin DIMM SDRAM		Total Memory
DIMM1 (Rows 0&1)	Single-Sided Double-Sided	x1	
DIMM2 (Rows 2&3)	Single-Sided (must be occupied before DIMM3) Double-Sided (DIMM3 must be empty)	x1	
DIMM3 (Rows 3&2)	Single-Sided (DIMM2 must be single-sided) (Double-Sided DIMM cannot be used here!) (must be same or half DIMM2 memory size)	x1	
Total System Memory (Max 512MB)		=	

NOTE: At the time this User's Manual was written, 256MB DIMM's are only available as Double-Sided registered memory (128Mbit cells). Using 2x2x2 SDRAM can greatly improve the onboard graphics' performance.

3.5.1 General DIMM Notes

- When this motherboard operates at 100MHz, PC100-compliant modules must be used because of the strict timing issues involved under this speed. If your DIMMs are not PC100-compliant, set the SDRAM bus frequency to 66MHz RAM but onboard graphics performance and PCI expansion cards will suffer tremendously.
- ASUS motherboards support SPD (Serial Presence Detect) DIMMs. This is the memory of choice for best performance vs. stability.
- SDRAM chips are generally thinner with higher pin density than EDO (Extended Data Output) chips.
- BIOS shows SDRAM memory on bootup screen.
- Single-sided DIMMs come in 16, 32, 64,128MB; double-sided come in 32, 64, 128, 256MB.

3. HARDWARE SETUP

3.5.2 DIMM Memory Installation

Insert the module(s) as shown. Because the number of pins are different on either side of the breaks, the module will only fit in the orientation shown. DIMM modules are longer and have different pin contact on each side and therefore have a higher pin density. SIMM modules have the same pin contact on both sides.

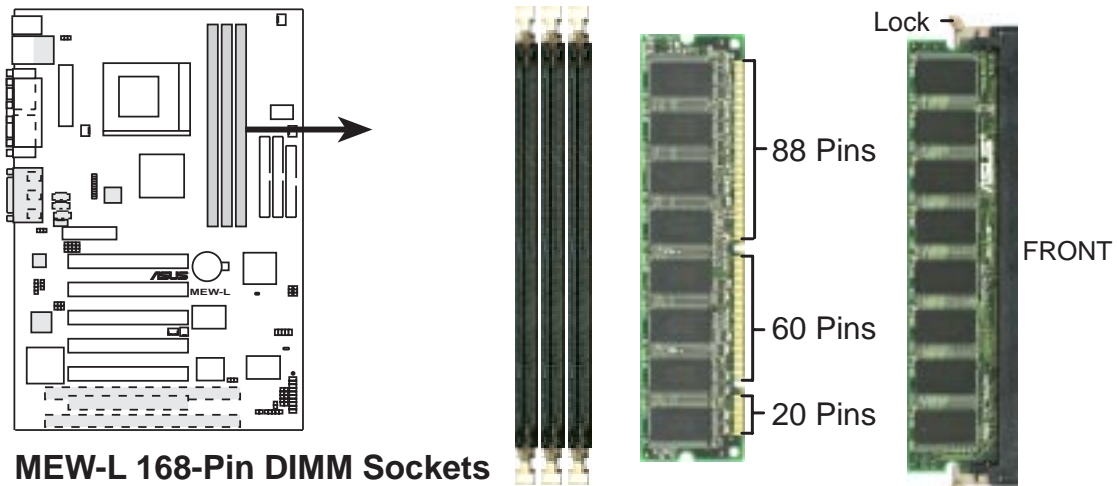

The DIMMs must be **3.3V Unbuffered** for this motherboard. To determine the DIMM type, check the notches on the DIMMs (see figure below).

168-Pin DIMM Notch Key Definitions (3.3V)

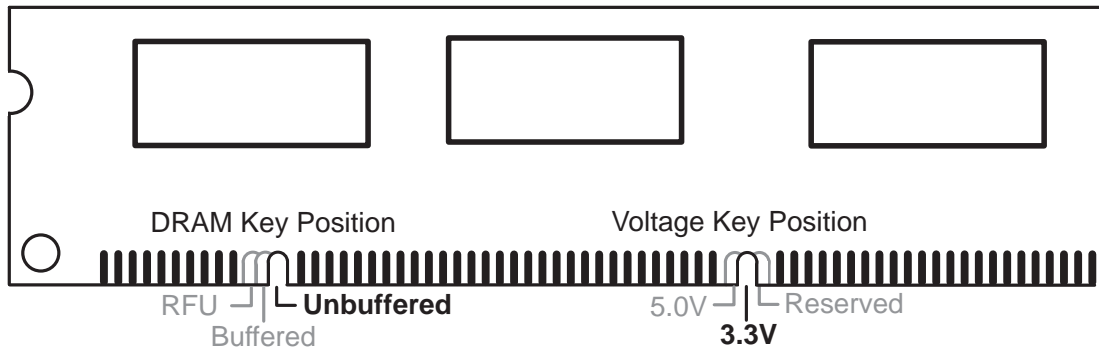

The notches on the DIMM module will shift between left, center, or right to identify the type and also to prevent the wrong type from being inserted into the DIMM slot on the motherboard. You must ask your retailer the correct DIMM type before purchasing. This motherboard supports four clock signals.

3. HARDWARE SETUP

3.6 Central Processing Unit (CPU)

The motherboard provides a ZIF Socket 370. The CPU that came with the motherboard should have a fan attached to it to prevent overheating. If this is not the case, then purchase a fan before you turn on your system.

WARNING! Be sure that there is sufficient air circulation across the processor's heatsink by regularly checking that your CPU fan is working. Without sufficient circulation, the processor could overheat and damage both the processor and the motherboard. You may install an auxiliary fan, if necessary.

To install a CPU, first turn off your system and remove its cover. Locate the ZIF socket and open it by first pulling the lever sideways away from the socket then upwards to a 90-degree angle. Insert the CPU with the correct orientation as shown. The notched corner should point towards the end of the lever. Because the CPU has a corner pin for two of the four corners, the CPU will only fit in the orientation as shown. The picture is for reference only; you should have a CPU fan that covers the face of the CPU. With the added weight of the CPU fan, no force is required to insert the CPU. Once completely inserted, close the socket's lever while holding down the CPU.

NOTE: Do not forget to set the correct Bus Frequency and Multiple (frequency multiple setting is available only on unlocked processors) for your Socket 370 processor or else boot-up may not be possible. Socket 370 processors provide internal thermal sensing so that a socket mounted thermal resistor is not needed.

CAUTION! Be careful not to scrape the motherboard when mounting a clamp-style processor fan or else damage may occur to the motherboard.

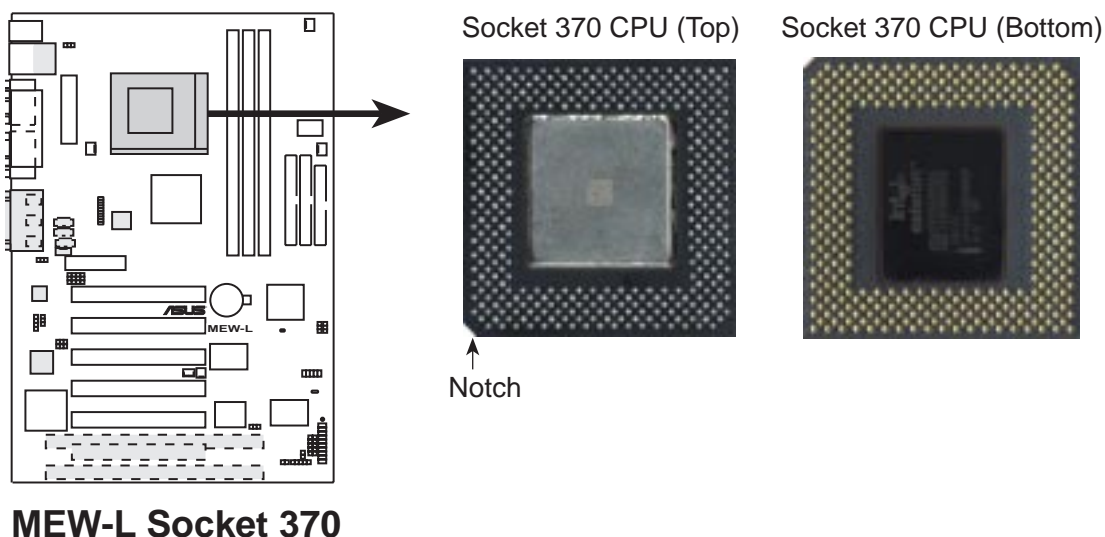

3. HARDWARE SETUP

3.7 Expansion Cards

WARNING! Make sure that you unplug your power supply when adding or removing expansion cards or other system components. Failure to do so may cause severe damage to both your motherboard and expansion cards.

3.7.1 Expansion Card Installation Procedure

1. Read the documentation for your expansion card and make any necessary hardware or software settings for your expansion card, such as jumpers or switches.
2. Remove your computer system's cover and the bracket plate with screw on the slot you intend to use. Keep the bracket for possible future use.
3. Carefully align the card's connectors and press firmly.
4. Secure the card on the slot with the screw you removed above.
5. Replace the computer system's cover.
6. Set up the BIOS if necessary
(such as *IRQ xx Used By ISA: Yes* in PNP AND PCI SETUP)
7. Install the necessary software drivers for your expansion card.

3.7.2 Assigning IRQs for Expansion Cards

Some expansion cards need to use an IRQ to operate. Generally, an IRQ must be exclusively assigned to one use. In a standard design, there are 16 IRQs available but most of them are already in use, leaving 6 IRQs free for expansion cards. If your motherboard has **PCI** audio onboard, an extra IRQ will be used. If your motherboard also has **Midi** enabled, an extra 1 IRQs will be used, leaving 4 IRQs free.

Both ISA and PCI expansion cards may require IRQs. System IRQs are available to cards installed in the ISA expansion bus first, then any remaining IRQs are available to PCI cards. Currently, there are two types of ISA cards.

The original ISA expansion card design, now referred to as "Legacy" ISA cards, requires that you configure the card's jumpers manually and then install it in any available slot on the ISA bus. To see a map of your used and free IRQs in Windows 98, the Control Panel icon in My Computer, contains a System icon, which gives you a Device Manager tab. Double-clicking on a specific hardware device gives you the Resources tab which shows the Interrupt number and address. Make sure that no two devices use the same IRQ or your computer will experience problems when those two devices are in use at the same time.

To simplify this process, this motherboard complies with the Plug and Play (PNP) specification which was developed to allow automatic system configuration whenever a PNP-compliant card is added to the system. For PNP cards, IRQs are assigned automatically from those available.

3. HARDWARE SETUP

If the system has both Legacy and PNP ISA cards installed, IRQs are assigned to PNP cards from those not used by Legacy cards. The PCI and PNP configuration of the BIOS setup utility can be used to indicate which IRQs are being used by Legacy cards. For older Legacy cards that does not work with the BIOS, you can contact your vendor for an ISA Configuration Utility.

An IRQ number is automatically assigned to PCI expansion cards after those used by Legacy and PNP ISA cards. In the PCI bus design, the BIOS automatically assigns an IRQ to a PCI slot that has a card in it that requires an IRQ. To install a PCI card, you need to set something called the INT (interrupt) assignment. Since all the PCI slots on this motherboard use an INTA #, be sure that the jumpers on your PCI cards are set to INT A.

3.7.3 Assigning DMA Channels for ISA Cards

Some ISA cards, both legacy and PnP, may also need to use a DMA (Direct Memory Access) channel. DMA assignments for this motherboard are handled the same way as the IRQ assignment process described earlier. To select a DMA channel, see **PCI/PNP ISA DMA Resource Exclusion** in *4.4.3 PCI Configuration*. **NOTE:** The on-board audio by default uses DMA1.

IMPORTANT: To avoid conflicts, reserve the necessary IRQs and DMAs for legacy ISA cards (see **PCI/PNP USA IRQ Resource Exclusion** in *4.4.3 PCI Configuration*). Choose *Yes* in **IRQ xx Used By ISA** and **DMA x Used By ISA** for those IRQs and DMAs you want to reserve).

3.7.4 Audio Modem Riser (AMR) Slot

This connector supports a specially designed audio and/or modem card called an AMR. Main processing is done through software and controlled by the motherboard's Intel Controller Hub (ICH). This provides an upgradeable audio and/or modem solution at an incredibly low cost. There are two types of AMR, one defined as primary and another defined as secondary. This motherboard uses the primary channel so that a secondary AMR can coexist without the need to disable the onboard CODEC. The motherboard's onboard CODEC must be disabled when using a primary AMR.

NOTE: An AMR is not included with this motherboard.

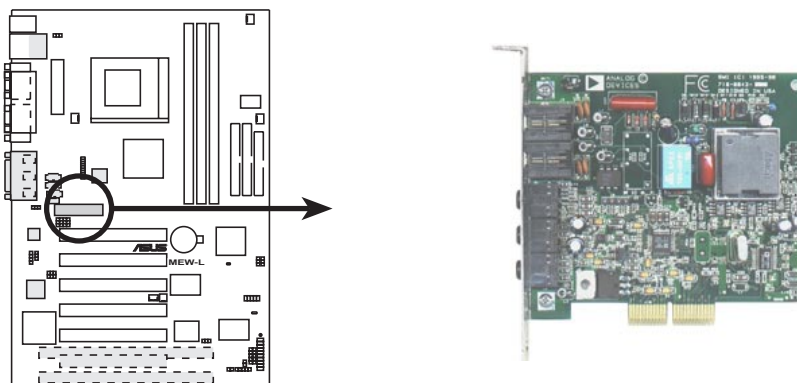

MEW-L Audio Modem Riser (AMR) Connector

3. HARDWARE SETUP

3.8 External Connectors

WARNING! Some pins are used for connectors or power sources. These are clearly distinguished from jumpers in the Motherboard Layout. Placing jumper caps over these connector pins will cause damage to your motherboard.

IMPORTANT: Ribbon cables should always be connected with the red stripe to Pin 1 on the connectors. Pin 1 is usually on the side closest to the power connector on hard drives and CD-ROM drives, but may be on the opposite side on floppy disk drives. Check the connectors before installation because there may be exceptions. Look on IDE ribbon cable must be less than 46 cm (18 in.), with the second drive connector no more than 15 cm (6 in.) from the first connector.

NOTE: Onboard Fast-Ethernet is optional at the time of purchase. The illustrations below are that of the model without the onboard Fast-Ethernet.

1) PS/2 Mouse Connector (Green 6-pin PS2KBMS)

The system will direct IRQ12 to the PS/2 mouse if one is detected. If one is not detected, expansion cards can use IRQ12. See **PS/2 Mouse Function Control** in *4.4 Advanced Menu*.

PS/2 Mouse (6-pin Female)

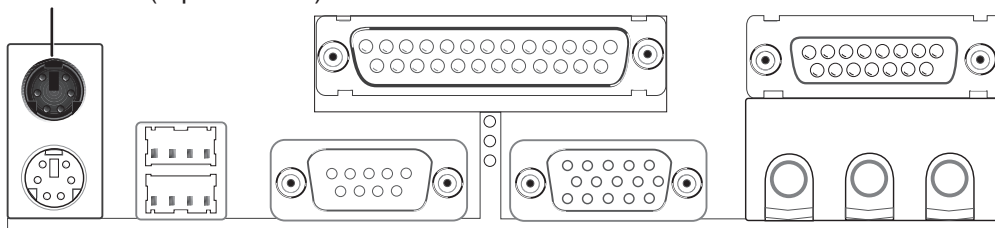

2) PS/2 Keyboard Connector (Purple 6-pin PS2KBMS)

This connection is for a standard keyboard using an PS/2 plug (mini DIN). **This connector will not allow standard AT size (large DIN) keyboard plugs. You may use a DIN to mini DIN adapter on standard AT keyboards.**

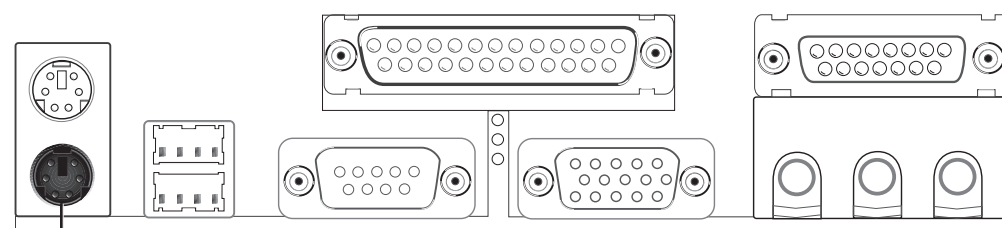

PS/2 Keyboard (6-pin Female)

3. HARDWARE SETUP

3) Universal Serial BUS Ports 1 & 2 (Black two 4-pin USB)

Two USB ports are available for connecting USB devices.

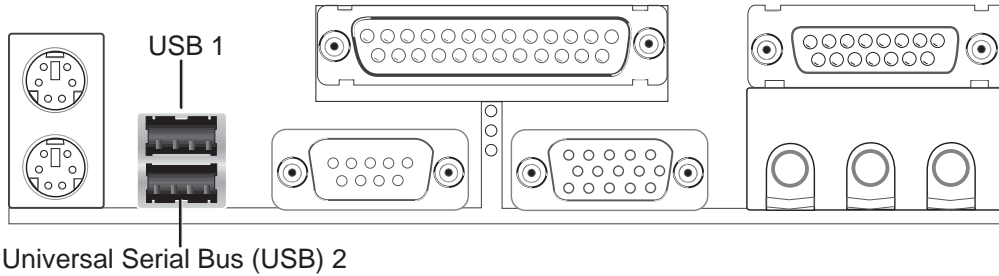

4) Parallel Port Connector (Burgundy 25-pin PRINTER)

You can enable the parallel port and choose the IRQ through **Onboard Parallel Port** (see **4.4.2 I/O Device Configuration**).

NOTE: Serial printers must be connected to the serial port.

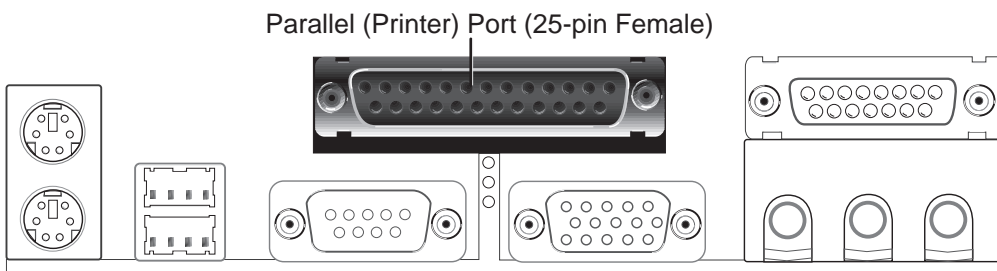

5) Serial Port COM1 Connector (Teal/Turquoise 9-pin COM1)

One serial port is ready for a mouse or other serial devices. A second serial port is available using a serial port bracket connected from the motherboard to an expansion slot opening. See **Onboard Serial Port 1** in **4.2.2 I/O Device Configuration** for settings.

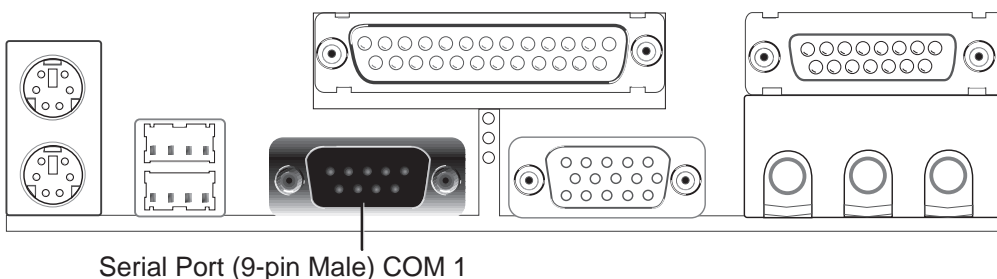

3. HARDWARE SETUP

6) Monitor Output Connector (Blue 15-pin VGA)

This connector is for output to a VGA-compatible device.

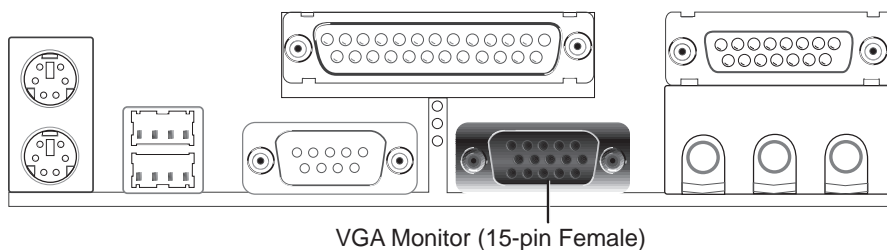

7) Joystick/MIDI Connector (Gold 15-pin GAME_AUDIO) (optional)

You may connect game joysticks or game pads to this connector for playing games. Connect MIDI devices for playing or editing professional audio.

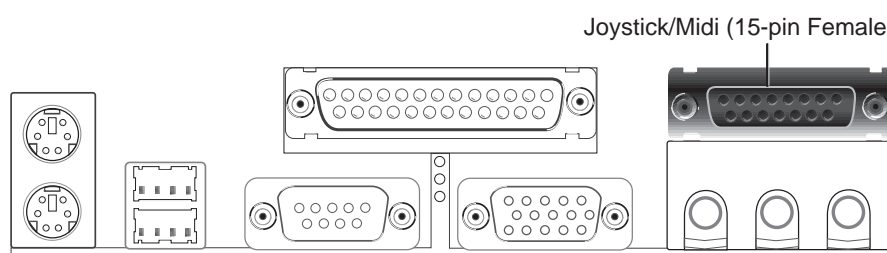

NOTE: The onboard game port is to be used only if you are not using any PCI or ISA audio card with a game port.

8) Audio Port Connectors (Three 1/8" GAME_AUDIO) (optional)

Line Out (lime) can be connected to headphones or preferably powered speakers. **Line In** (light blue) allows tape players or other audio sources to be recorded by your computer or played through the **Line Out** (lime). **Mic** (pink) allows microphones to be connected for inputting voice.

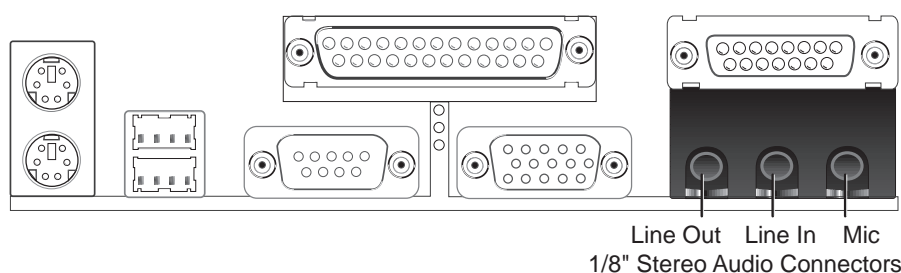

9) Fast-Ethernet Port Connector (RJ45) (optional)

The RJ45 connector is optional at the time of purchase and is located on top of the USB connectors. The connector allows the motherboard to connect to a Local Area Network (LAN) through a network hub.

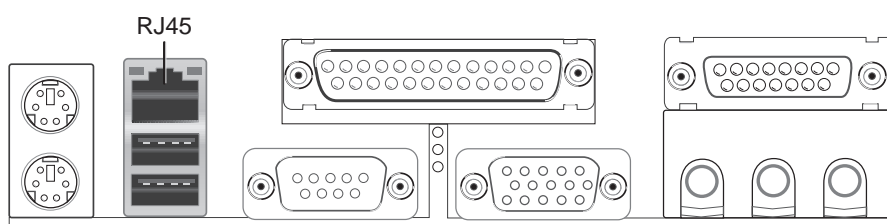

3. HARDWARE SETUP

10) Primary / Secondary IDE Connectors (Two 40-1pin IDE)

These connectors support the provided IDE hard disk ribbon cable. After connecting the single end to the board, connect the two plugs at the other end to your hard disk(s). If you install two hard disks, you must configure the second drive to Slave mode by setting its jumper accordingly. Please refer to your hard disk documentation for the jumper settings. BIOS now supports specific device bootup (see **Boot Sequence** in *4.6 Boot Menu*). **(Pin 20 is removed to prevent inserting in the wrong orientation when using ribbon cables with pin 20 plugged).**

TIP: You may configure two hard disks to be both Masters with two ribbon cables – one for the primary IDE connector and another for the secondary IDE connector. You may install one operating system on an IDE drive and another on a SCSI drive and select the boot disk through **Boot Sequence** in *4.6 Boot Menu*. **IMPORTANT: UltraDMA/66 IDE devices must use an 80 pin IDE cable.**

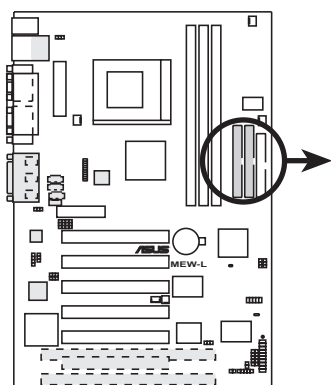

MEW-L IDE Connectors

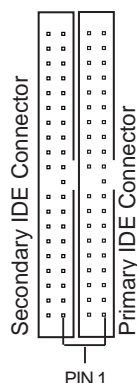

NOTE: Orient the red markings (usually zigzag) on the IDE ribbon cable to PIN 1

11) Floppy Disk Drive Connector (34-1pin FLOPPY)

This connector supports the provided floppy drive ribbon cable. After connecting the single end to the board, connect the two plugs on the other end to the floppy drives. **(Pin 5 is removed to prevent inserting in the wrong orientation when using ribbon cables with pin 5 plugged).**

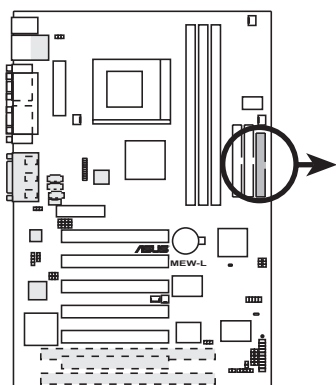

MEW-L Floppy Disk Drive Connector

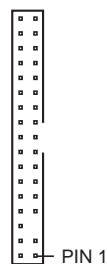

NOTE: Orient the red markings on the floppy ribbon cable to PIN 1

3. HARDWARE SETUP

12) Wake-On-LAN Connector (3-pin WOL_CON)

This connector connects to a LAN card with a Wake-On-LAN output, such as the ASUS PCI-L101 Ethernet card (not required for onboard LAN model). The connector powers up the system when a wakeup packet or signal is received through the LAN card.

IMPORTANT: This feature requires that **Wake On LAN** is set to *Enabled* (see **4.5.1 Power Up Control**) and that your system has an ATX power supply with at least 720mA +5V standby power.

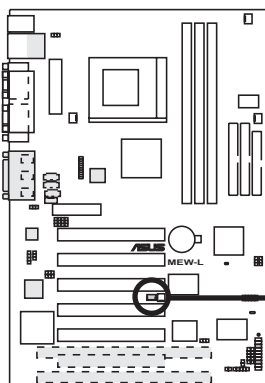

IMPORTANT: Requires an ATX power supply with at least 720mA +5 volt standby power

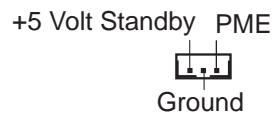

MEW-L Wake-On-LAN Connector

13) Wake-On-Ring Connector (2-pin WOR)

This connector connects to internal modem cards with a Wake-On-Ring output. The connector powers up the system when a ringup packet or signal is received through the internal modem card. **NOTE:** For external modems, Wake-On-Ring is detected through the COM port.

IMPORTANT: This feature requires that **PWR Up On Modem Act** is set to *Enabled* (see **4.5.1 Power Up Control**) and that your system has an ATX power supply with at least 720mA +5V standby power.

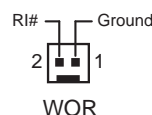
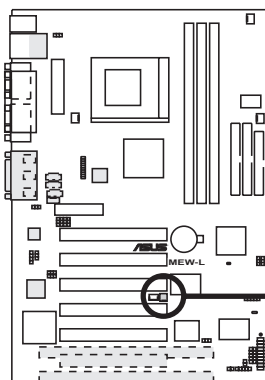

MEW-L Wake-On-Ring Connector

3. HARDWARE SETUP

14) IDE Activity LED (2-pin IDE)

This connector supplies power to the cabinet's IDE activity LED. Read and write activity by devices connected to the Primary or Secondary IDE connectors will cause the LED to light up.

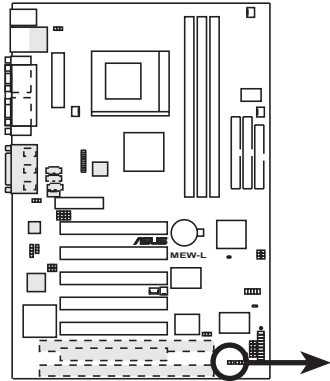

MEW-L IDE Activity LED

TIP: If the case-mounted LED does not light, try reversing the 2-pin plug.



15) Chassis, CPU, & Power Supply Fan Connectors (3-pin CHA_, CPU_, PWR_FAN)

These connectors support cooling fans of 350mA (4.2 Watts) or less. Orientate the fans so that the heat sink fins allow airflow to go across the onboard heat sink(s) instead of the expansion slots. Depending on the fan manufacturer, the wiring and plug may be different. The red wire should be positive, while the black should be ground. Connect the fan's plug to the board taking into consideration the polarity of the connector.

NOTE: The "Rotation" signal is to be used only by a specially designed fan with rotation signal. The Rotations per Minute (RPM) can be monitored using ASUS PC Probe Utility or Intel LDCM Utility (see section 6. SOFTWARE REFERENCE).

WARNING! The CPU and/or motherboard will overheat if there is no airflow across the CPU and onboard heatsinks. Damage may occur to the motherboard and/or the CPU fan if these pins are incorrectly used. **These are not jumpers, do not place jumper caps over these pins.**

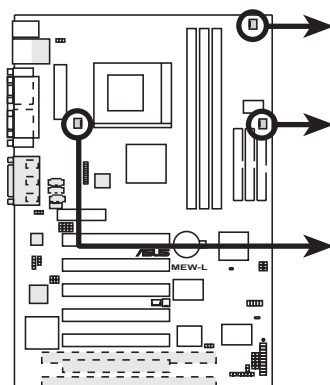

MEW-L 12-Volt Cooling Fan Power

CPU Fan Power

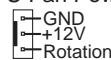

Chassis Fan Power



Power Supply Fan

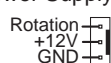

3. HARDWARE SETUP

16) Internal Audio Connectors (4-pin VIDEO, AUX, CD, TAD)

These connectors allow you to receive stereo audio input from such sound sources as a CD-ROM, TV tuner, or MPEG card. The TAD connector allows the on-board audio to interface with a voice modem card with a similar connector. It also allows the sharing of mono_in (such as a phone) and mono_out (such as a speaker) between the onboard audio and the voice modem card.

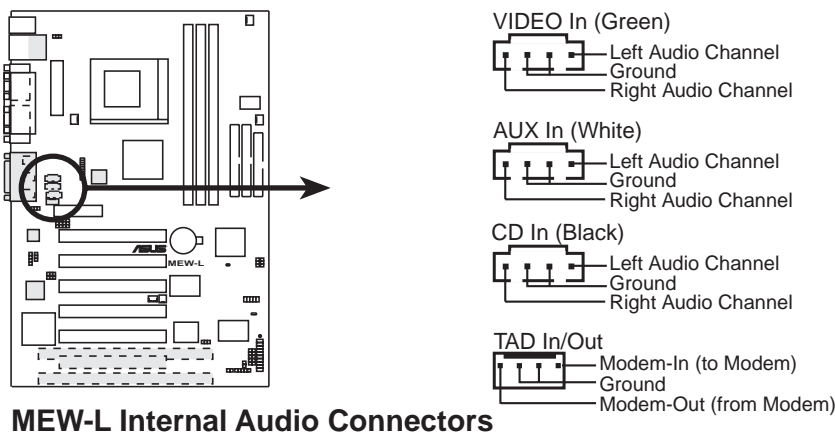

MEW-L Internal Audio Connectors

17) Internal Speaker Connector (INT_SPKA)

This connector allows you to connect the internal chassis speaker to the onboard audio's output. This will allow you to use the chassis' built-in speaker to listen to sounds normally requiring separately purchased external speakers. The ground (GND) wire is usually the black wire and the speaker-out (SPKOUT) is usually the red wire. System beeps and warnings sent through the chassis speaker connector is also routed through the INT_SPKA so that two speakers are not needed.

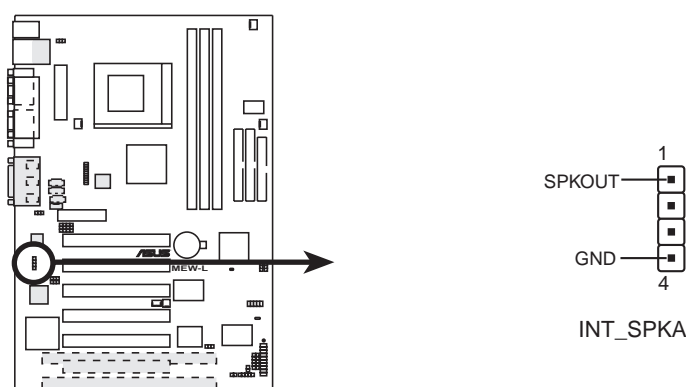

MEW-L Internal Speaker Connector

3. HARDWARE SETUP

18) Standard IR (SIR) (5-1 pin) and Consumer IR (CIR) (5-pin) Connectors

This connector supports an optional wireless transmitting and receiving infrared module. This module mounts to a small opening on system cases that support this feature. You must also configure the setting through **UART2 Use Infrared** (see **4.4.2 I/O Device Configuration**) to select whether UART2 is directed for use with COM2 or IrDA. Use the five pins as shown in Back View and connect a ribbon cable from the module to the motherboard's SIR connector according to the pin definitions. An optional consumer infrared (CIR) set connects to the CIR and SIR connectors simultaneously for both wireless transmitting and remote control functions through one external infrared module. **Wake On PS2 KB/Mouse** in **4.5.1 Power Up Control** must be Enabled in order to use Consumer Infrared (CIR) power up.

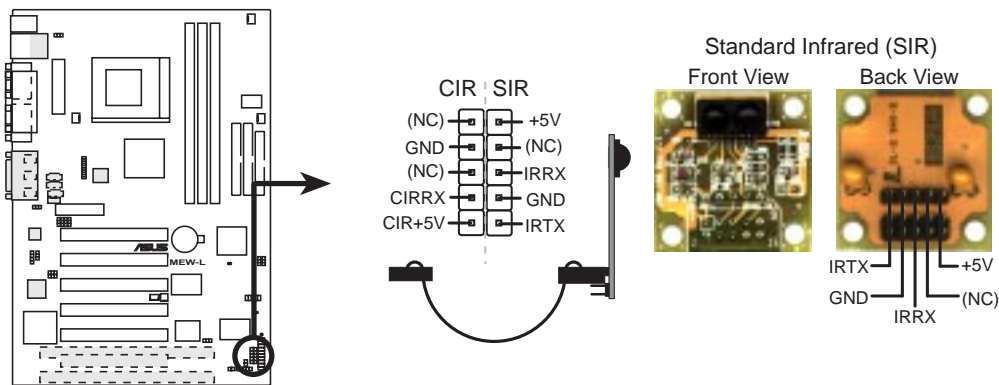

MEW-L Infrared Module Connector

19) Serial Port COM 2 Header (10-1 pin COM2)

The optional serial port bracket can be used to add an additional serial port for additional serial devices. The connector with bracket shown here is for the non-LCD model.

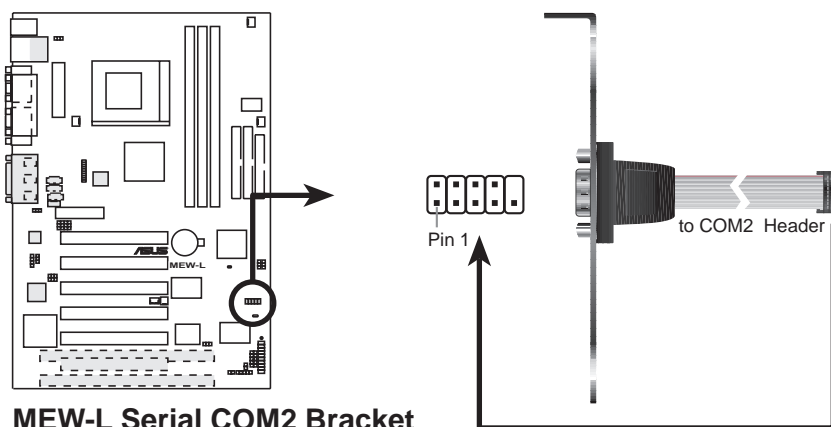

MEW-L Serial COM2 Bracket

3. HARDWARE SETUP

20) SMBus Connector (5-1 pin SMB)

This connector allows you to connect SMBus (System Management Bus) devices. SMBus devices communicate by means of the SMBus with an SMBus host and/or other SMBus devices. SMBus is a specific implementation of an I²C bus, which is a multi-device bus; that is, multiple chips can be connected to the same bus and each one can act as a master by initiating data transfer.

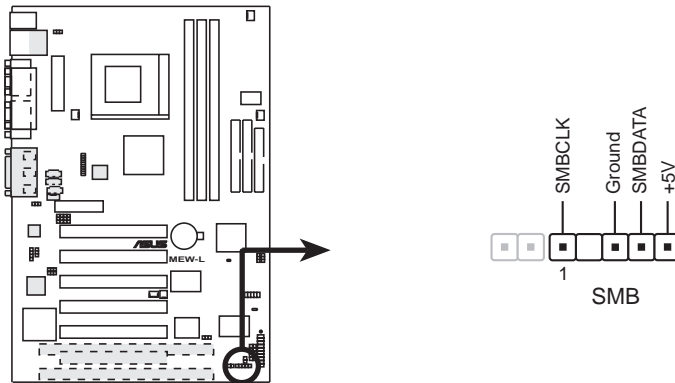

MEW-L SMBus Connector

21) Digital LCD Header (20-pin LCDHD)

This header requires a digital LCD cable connector. For the LCD model, the individual serial cable with bracket is replaced with the LCD and serial combination cable with bracket (as shown here). Connect the digital LCD cable to the LCD header and the serial cable to the COM2 header and mount the bracket to the chassis on a free expansion slot. **NOTE:** If both CRT and digital LCD monitors are used, the CRT will take precedent. This connector is for a digital LCD panel; an analog LCD panel comes with a 15-pin VGA cable connector to be used on the monitor connector. The connectors with bracket shown here are provided with the LCD model.

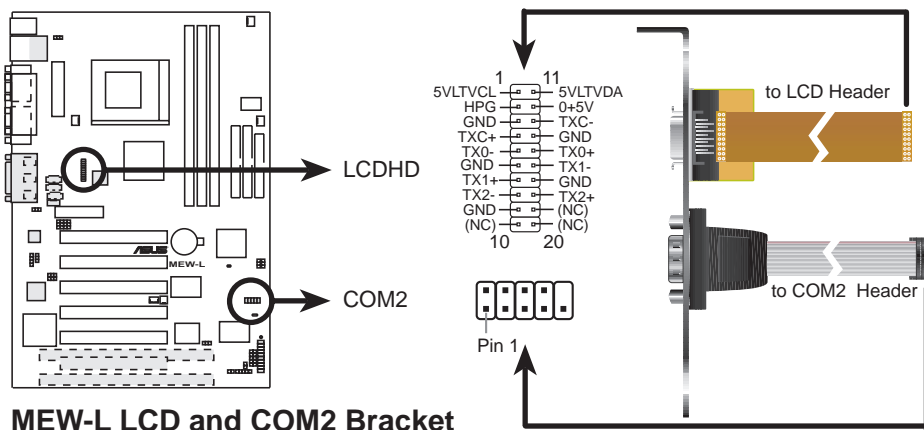

MEW-L LCD and COM2 Bracket

3. HARDWARE SETUP

22) Internal Microphone Connector (3 pin INT MIC)

This connector allows you to connect a chassis mounted microphone to the motherboard instead of having to attach an external microphone onto the ATX connectors.

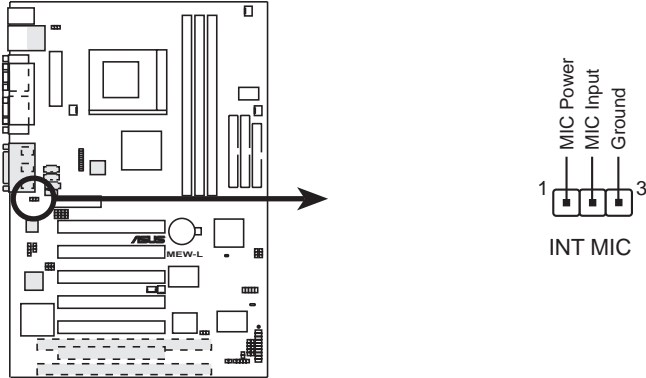

MEW-L Internal Microphone Connector

3. HARDWARE SETUP

23. Chassis Intrusion Lead (2 pin CHA)

This lead is for a chassis designed for chassis intrusion detection. After-market toggle switches may also be installed to the chassis panel or on any removable components. Two wires should be available from the chassis to connect to this lead. When any chassis component is removed, the contact should open and the motherboard will record a chassis intrusion event. The event can then be processed by software such as LDCM. If the chassis intrusion lead is not used, a jumper cap must be placed over the pins to prevent unnecessary power loss.

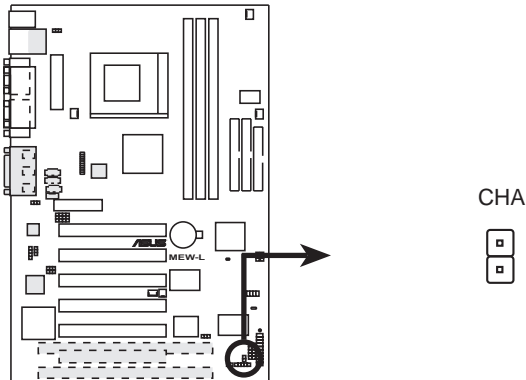

MEW-L Chassis Open Alarm Lead

24) ATX Power Supply Connector (20-pin block ATXPWR)

This connector connects to an ATX power supply. The plug from the power supply will only insert in one orientation because of the different hole sizes. Find the proper orientation and push down firmly making sure that the pins are aligned.

IMPORTANT: Make sure that your ATX power supply can supply at least 10mA on the +5-volt standby lead (+5VSB). You may experience difficulty in powering ON your system if your power supply cannot support the load. For Wake-On-LAN support, your ATX power supply must supply at least 720mA +5VSB.

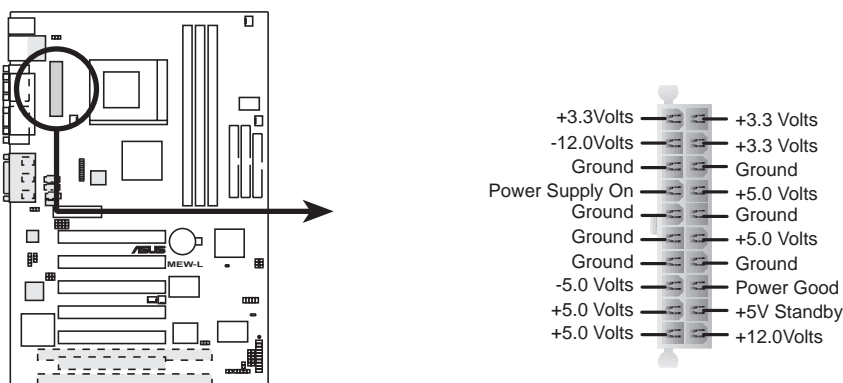

MEW-L ATX Power Connector

3. HARDWARE SETUP

The following PANEL illustration is used for items 26-32

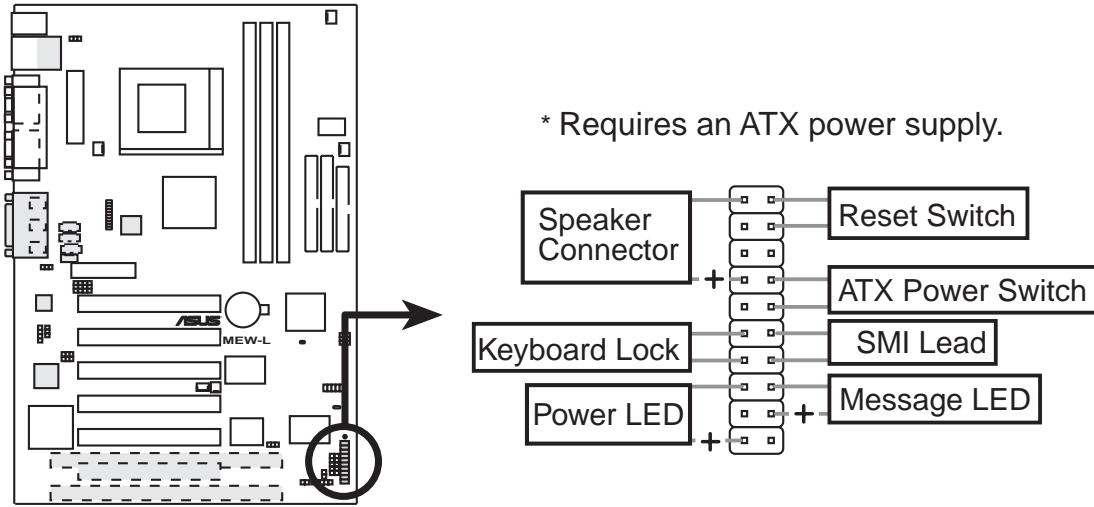

MEW-L System Panel Connectors

3. HARDWARE SETUP

25) System Warning Speaker Connector (4-pin SPEAKER)

This 4-pin connector connects to the case-mounted speaker. You may leave this disconnected if you connect the chassis speaker to the INT_SPKA. All three sources (LINE_OUT, INT_SPKA, SPEAKER) will allow you to hear system beeps and warnings. Only LINE_OUT will allow you to hear system beeps before the integrated audio has been properly initialized.

26) Keyboard Lock Switch Lead (2-pin KEYLOCK)

This 2-pin connector connects to the case-mounted key switch to allow keyboard locking.

27) System Power LED Lead (3-1 pin PLED)

This 3-1 pin connector connects the system power LED, which lights when the system is powered on and blinks when it is in sleep mode.

28) Reset Switch Lead (2-pin RESET)

This 2-pin connector connects to the case-mounted reset switch for rebooting your computer without having to turn off your power switch. This is a preferred method of rebooting to prolong the life of the system's power supply.

29) ATX Power Switch Lead (2-pin PWRSW)

The system power is controlled by a momentary switch connected to this lead. Pressing the button once will switch the system between ON and SOFT OFF. Pushing the switch while in the ON mode for more than 4 seconds will turn the system off. The system power LED shows the status of the system's power.

30) System Management Interrupt Lead (2-pin SMI)

This allows the user to manually place the system into a suspend mode or "Green" mode, where system activity is decreased to save electricity and expand the life of certain components when the system is not in use. This 2-pin connector connects to the case-mounted suspend switch. If you do not have a switch for the connector, you may use the "Turbo Switch." SMI is activated when it detects a *short to open* moment and therefore leaving it shorted will not cause any problems. This may require one or two presses depending on the position of the switch. Wake-up can be controlled by settings in the BIOS but the keyboard will always allow wake-up (the SMI lead cannot wake up the system).

31) Message LED Lead (2-pin LED)

This indicates whether a message has been received from a fax/modem. The LED will remain lit when there is no signal and blink when there is data transfer or waiting in the inbox. This function requires ACPI OS and driver support.

3. HARDWARE SETUP

(This page was intentionally left blank)

3. HARDWARE SETUP

3.9 Power Connection Procedures

1. After all connections are made, close the system case cover.
 2. Be sure that all switches are OFF (in some systems, marked with ○).
 3. Connect the power supply cord into the power supply located on the back of your system case according to your system user's manual.
 4. Connect the power cord into a power outlet that is equipped with a surge protector.
 5. You may then turn ON your devices in the following order:
 - a. Your monitor
 - b. External SCSI devices (starting with the last device on the chain)
 - c. Your system power. For ATX power supplies, you need to switch ON the power supply as well as press the ATX power switch on the front of the case.
 6. The power LED on the front panel of the system case will light. For ATX power supplies, the system LED will light when the ATX power switch is pressed. The LED on the monitor may light up or switch between orange and green after the system's if it complies with "green" standards or if it has a power standby feature. The system will then run power-ON tests. While the tests are running, additional messages will appear on the screen. If you do not see anything within 30 seconds from the time you turn ON the power, the system may have failed a power-ON test. Recheck your jumper settings and connections or call your retailer for assistance.
 7. During power-ON, hold down <Delete> to enter BIOS setup. Follow the instructions in **4. BIOS SETUP**.
- * **Powering Off your computer:** You must first exit or shut down your operating system before switching OFF the power switch. For ATX power supplies, you can press the ATX power switch after exiting or shutting down your operating system. If you use Windows 95, click the **Start** button, click **Shut Down**, and then click **Shut down the computer?** The power supply should turn OFF after Windows shuts down.

NOTE: The message "You can now safely turn off your computer" will not appear when shutting down with ATX power supplies.

4. BIOS SETUP

4.1 Managing and Updating Your BIOS

4.1.1 Upon First Use of the Computer System

It is recommended that you save a copy of the original motherboard BIOS along with a Flash Memory Writer utility (AFLASH.EXE) to a bootable floppy disk in case you need to reinstall the BIOS later. **AFLASH.EXE** is a Flash Memory Writer utility that updates the BIOS by uploading a new BIOS file to the programmable flash ROM on the motherboard. This file works only in DOS mode. To determine the BIOS version of your motherboard, check the last four numbers of the code displayed on the upper left-hand corner of your screen during bootup. Larger numbers represent a newer BIOS file.

1. Type **FORMAT A:/S** at the DOS prompt to create a bootable system floppy disk. **DO NOT** copy AUTOEXEC.BAT & CONFIG.SYS to the disk.
2. Type **COPY D:\AFLASH\AFLASH.EXE A:** (assuming D is your CD-ROM drive) to copy AFLASH.EXE to the just created boot disk.

NOTE: AFLASH works only in DOS mode. It will not work with DOS prompt in Windows and will not work with certain memory drivers that may be loaded when you boot from your hard drive. It is recommended that you reboot using a floppy.

3. Reboot your computer from the floppy disk. **NOTE:** BIOS setup must specify “Floppy” as the first item in the boot sequence.
4. In DOS mode, type **A:\AFLASH <Enter>** to run AFLASH.

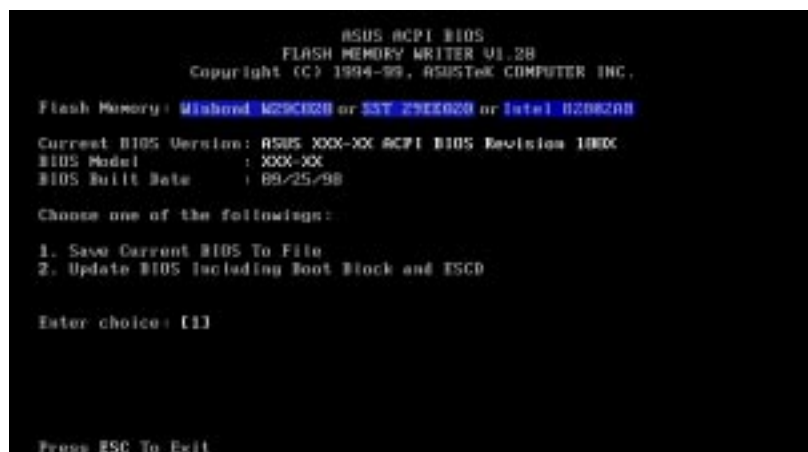

```
ASUS ACPI BIOS
FLASH MEMORY WRITER V1.28
Copyright (C) 1994-99, ASUSTek COMPUTER INC.

Flash Memory: Winbond W29C028 or SST 29EE028 or Intel H206208

Current BIOS Version: ASUS XXX-XX ACPI BIOS Revision 100C
BIOS Model          : XXX-XX
BIOS Built Date     : 89/25/98

Choose one of the followings:

1. Save Current BIOS To File
2. Update BIOS including Boot Block and ESCD

Enter choice: [1]

Press ESC To Exit
```

IMPORTANT! If “unknown” is displayed after **Flash Memory:**, the memory chip is either not programmable or is not supported by the ACPI BIOS and therefore, cannot be programmed by the Flash Memory Writer utility.

4. BIOS SETUP

5. Select **1. Save Current BIOS to File** from the Main menu and press <Enter>. The **Save Current BIOS To File** screen appears.

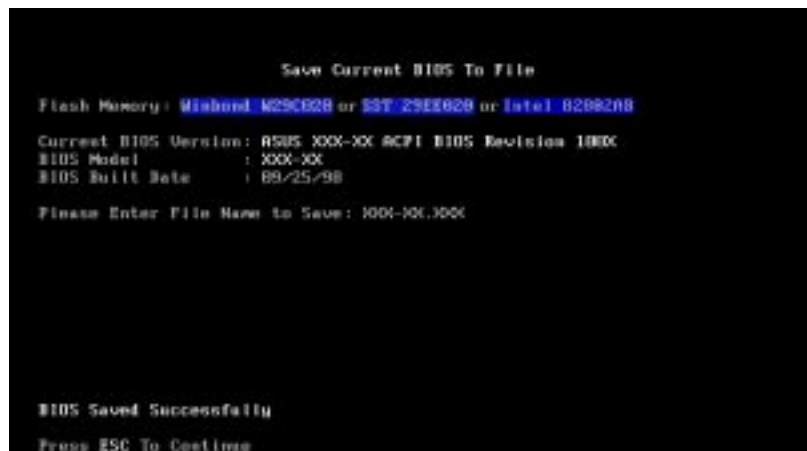

6. Type a filename and the path, for example, **A:\XXX-XX.XXX** and then press <Enter>.

4.1.2 Updating BIOS Procedures

WARNING! Only update your BIOS if you have problems with your motherboard and you know that the new BIOS revision will solve your problems. Careless updating can result in your motherboard having more problems!

1. Download an updated ASUS BIOS file from the Internet (WWW or FTP) (see ASUS CONTACT INFORMATION on page 3 for details) and save to the disk you created earlier.
2. Boot from the disk you created earlier.
3. At the “A:\” prompt, type **AFLASH** and then press <Enter>.
4. At the **Main Menu**, type **2** and then press <Enter>. The **Update BIOS Including Boot Block and ESCD** screen appears.
5. Type the filename of your new BIOS and the path, for example, **A:\XXX-XX.XXX**, and then press <Enter>.

NOTE: To cancel this operation, press <Enter>.



4. BIOS SETUP

- When prompted to confirm the BIOS update, press **Y** to start the update.

```
Update BIOS Including Boot Block and ESCD
Flash Memory: Winbond_M28C02B or SST_29C060B or Intel_B28A24B

BIOS Version
[CURRENT] ASUS 1001-XX ACPI BIOS Revision 100X
[Last used] ASUS 1001-XX ACPI BIOS Revision 100X

BIOS Model
[CURRENT] XXX-XX
[Last used] XXX-XX

Date of BIOS Build
[CURRENT] 05/25/08
[XXXX.XXXX] 05/25/08

Notice: Boot Block is different. Check sum of 1001.XXX is F205.

Are you sure (Y/N) ? [Y]

Press ESC To Return to Main Menu
```

- The utility starts to program the new BIOS information into the flash ROM. The boot block will be updated automatically only when necessary. This will minimize the chance that a failed update will prevent your system from booting up. When the programming is finished, *Flashed Successfully* will be displayed.

```
Update BIOS Including Boot Block and ESCD
Flash Memory: Winbond_M28C02B or SST_29C060B or Intel_B28A24B

BIOS Version
[CURRENT] ASUS 1001-XX ACPI BIOS Revision 100X
[Last used] ASUS 1001-XX ACPI BIOS Revision 100X

BIOS Model
[CURRENT] XXX-XX
[Last used] XXX-XX

Date of BIOS Build
[CURRENT] 05/25/08
[XXXX.XXXX] 05/25/08

Notice: Boot Block is different. Check sum of 1001.XXX is F205.

Are you sure (Y/N) ? [Y]
Block Erasing -- Done
Programming -- 3F77F
Flashed Successfully

Press ESC To Continue
```

- Follow the onscreen instructions to continue.

```
ASUS ACPI BIOS
FLASH MEMORY WRITER V0.20
Copyright (C) 1994-99, ASUSTeK COMPUTER INC.

Flash Memory: Winbond_M28C02B or SST_29C060B or Intel_B28A24B

Current BIOS Version: ASUS 1001-XX ACPI BIOS Revision 100X
BIOS Model : XXX-XX
BIOS Build Date : 05/25/08

Choose one of the following:
1. Save Current BIOS To File
2. Update BIOS Including Boot Block and ESCD

Enter choice: 111

You have Flashed the EPROM. It is recommended that you turn off
the power, enter SETUP and LOAD Setup Defaults to have CMOS
updated with new BIOS when exits.

Press ESC To Exit
```

WARNING! If you encounter problems while updating the new BIOS, DO NOT turn OFF your system since this might prevent your system from booting up. Just repeat the process, and if the problem still persists, update the original BIOS file you saved to disk above. If the Flash Memory Writer utility was not able to successfully update a complete BIOS file, your system may not be able to boot up. If this happens, your system will need servicing.

4. BIOS SETUP

4.2 BIOS Setup Program

This motherboard supports a programmable EEPROM that can be updated using the provided utility as described in *4.1 Flash Memory Writer Utility*.

The utility is used if you are installing a motherboard, reconfiguring your system, or prompted to “**Run Setup**”. This section describes how to configure your system using this utility.

Even if you are not prompted to use the Setup program, at some time in the future you may want to change the configuration of your computer. For example, you may want to enable the Security Password Feature or make changes to the power management settings. It will then be necessary to reconfigure your system using the BIOS Setup program so that the computer can recognize these changes and record them in the CMOS RAM of the EEPROM.

The EEPROM on the motherboard stores the Setup utility. When you start up the computer, the system provides you with the opportunity to run this program. This appears during the Power-On Self Test (POST). Press <Delete> to call up the Setup utility. If you are a little bit late in pressing the mentioned key, POST will continue with its test routines, thus preventing you from calling up Setup. If you still need to call Setup, restart the system by pressing <Ctrl> + <Alt> + <Delete>, or by pressing the Reset button on the system chassis. You can also restart by turning the system OFF and then back ON again. But do so only if the first two methods fail.

The Setup program has been designed to make it as easy to use as possible. It is a menu-driven program, which means you can scroll through the various sub-menus and make your selections among the predetermined choices.

To access the BIOS Setup program, press the <Delete> key after the computer has run through its POST.

NOTE: Because the BIOS software is constantly being updated, the following BIOS screens and descriptions are for reference purposes only and may not reflect your BIOS screens exactly.

4. BIOS SETUP

4.2.1 BIOS Menu Bar

The top of the screen has a menu bar with the following selections:

- MAIN** Use this menu to make changes to the basic system configuration.
- ADVANCED** Use this menu to enable and make changes to the advanced features.
- POWER** Use this menu to configure and enable Power Management features.
- BOOT** Use this menu to configure the default system device used to locate and load the Operating System.
- EXIT** Use this menu to exit the current menu or specify how to exit the Setup program.

To access the menu bar items, press the right or left arrow key on the keyboard until the desired item is highlighted.

4.2.2 Legend Bar

At the bottom of the Setup screen you will notice a legend bar. The keys in the legend bar allow you to navigate through the various setup menus. The following table lists the keys found in the legend bar with their corresponding alternates and functions.

Navigation Key(s)	Function Description
<F1> or <Alt + H>	Displays the General Help screen from anywhere in the BIOS Setup
<Esc>	Jumps to the Exit menu or returns to the main menu from a sub-menu
← or → (keypad arrow)	Selects the menu item to the left or right
↑ or ↓ (keypad arrows)	Moves the highlight up or down between fields
- (minus key)	Scrolls backward through the values for the highlighted field
+ (plus key) or spacebar	Scrolls forward through the values for the highlighted field
<Enter>	Brings up a selection menu for the highlighted field
<Home> or <PgUp>	Moves the cursor to the first field
<End> or <PgDn>	Moves the cursor to the last field
<F5>	Resets the current screen to its Setup Defaults
<F10>	Saves changes and exits Setup

4. BIOS SETUP

General Help

In addition to the Item Specific Help window, the BIOS setup program also provides a General Help screen. This screen can be called up from any menu by simply pressing <F1> or the <Alt> + <H> combination. The General Help screen lists the legend keys with their corresponding alternates and functions.

Saving Changes and Exiting the Setup Program

See *4.7 Exit Menu* for detailed information on saving changes and exiting the setup program.

Scroll Bar

When a scroll bar appears to the right of a help window, it indicates that there is more information to be displayed that will not fit in the window. Use <PgUp> and <PgDn> or the up and down arrow keys to scroll through the entire help document. Press <Home> to display the first page, press <End> to go to the last page. To exit the help window, press <Enter> or <Esc>.

Sub-Menu

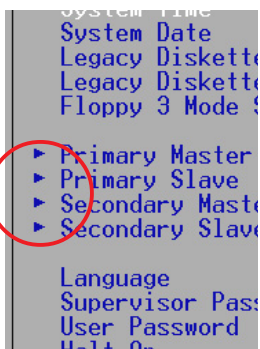

Note that a right pointer symbol (as shown in the left view) appears to the left of certain fields. This pointer indicates that a sub-menu can be launched from this field. A sub-menu contains additional options for a field parameter. To call up a sub-menu, simply move the highlight to the field and press <Enter>. The sub-menu will then immediately appear. Use the legend keys to enter values and move from field to field within a sub-menu just as you would within a menu. Use the <Esc> key to return to the main menu.

Take some time to familiarize yourself with each of the legend keys and their corresponding functions. Practice navigating through the various menus and sub-menus. If you accidentally make unwanted changes to any of the fields, use the set default hot key <F5>. While moving around through the Setup program, note that explanations appear in the Item Specific Help window located to the right of each menu. This window displays the help text for the currently highlighted field.

NOTE: The item heading in square brackets represents the default setting for that field.

4. BIOS SETUP

4.3 Main Menu

When the Setup program is accessed, the following screen appears:

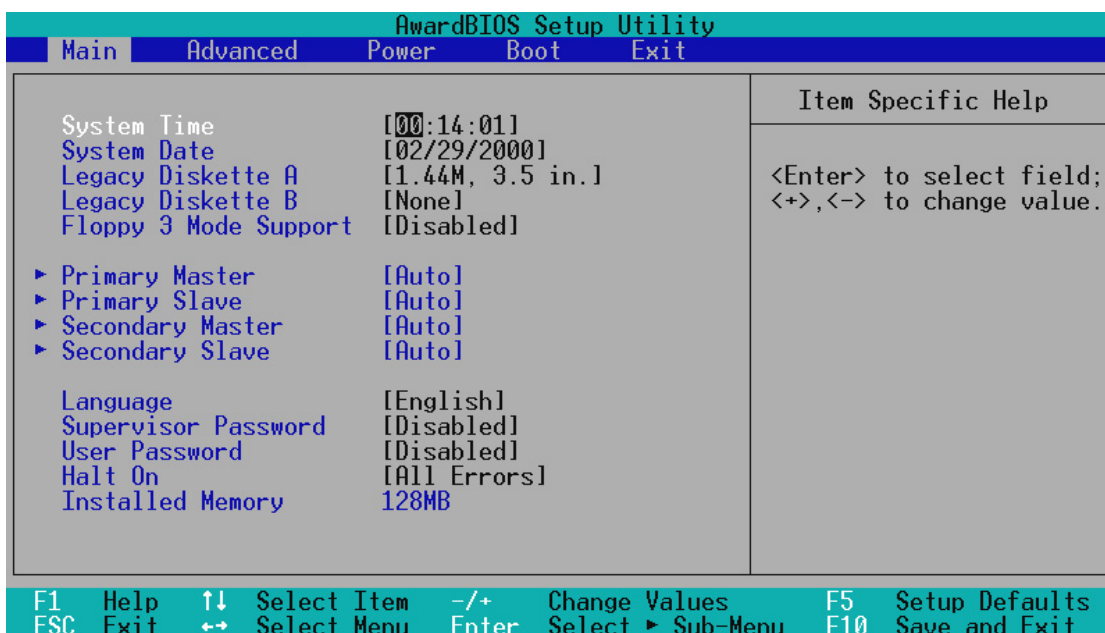

System Time [XX:XX:XX]

Sets your system to the time that you specify (usually the current time). The format is hour, minute, second. Valid values for hour, minute and second are **Hour: (00 to 23)**, **Minute: (00 to 59)**, **Second: (00 to 59)**. Use the <Tab> or <Shift> + <Tab> keys to move between the hour, minute, and second fields.

System Date [XX/XX/XXXX]

Sets your system to the date that you specify (usually the current date). The format is month, day, year. Valid values for month, day, and year are **Month: (1 to 12)**, **Day: (1 to 31)**, **Year: (100 year range)**. Use the <Tab> or <Shift> + <Tab> keys to move between the month, day, and year fields.

Legacy Diskette A [1.44M, 3.5 in.], Legacy Diskette B [None]

Sets the type of floppy drives installed. Configuration options: [None] [360K, 5.25 in.] [1.2M , 5.25 in.] [720K , 3.5 in.] [1.44M, 3.5 in.] [2.88M, 3.5 in.]

Floppy 3 Mode Support [Disabled]

This is required to support older Japanese floppy drives. Floppy 3 Mode support will allow reading and writing of 1.2MB (as opposed to 1.44MB) on a 3.5-inch diskette. Configuration options: [Disabled] [Drive A] [Drive B] [Both]

4. BIOS SETUP

4.3.1 Primary & Secondary Master/Slave

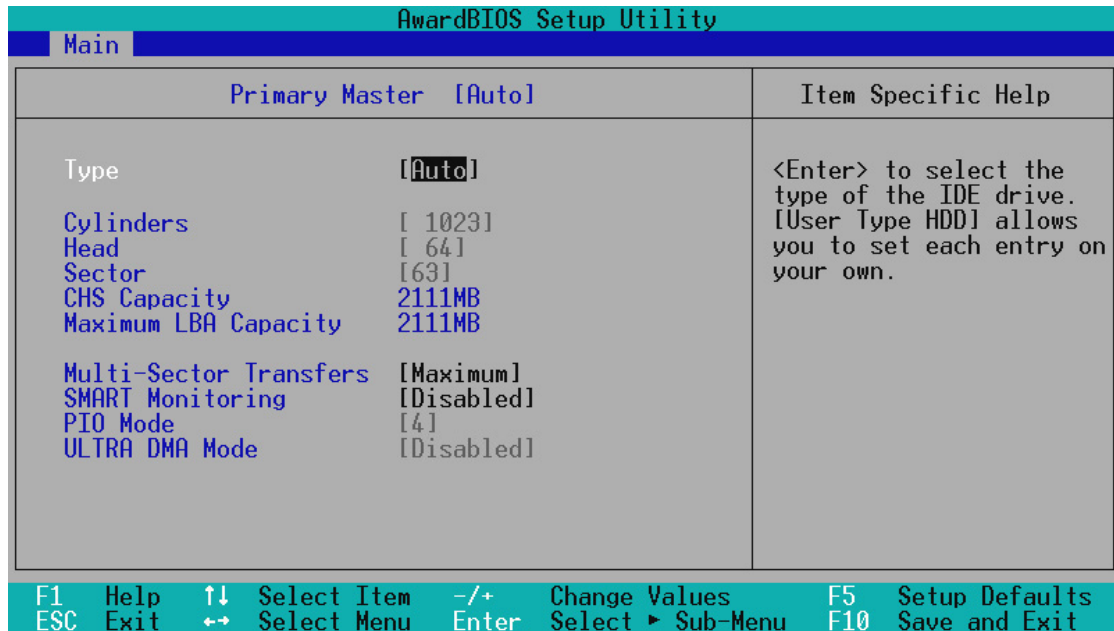

NOTE: Before attempting to configure a hard disk drive, make sure you have the configuration information supplied by the manufacturer of the drive. Incorrect settings may cause your system to not recognize the installed hard disk. To allow the BIOS to detect the drive type automatically, select [Auto].

Type [Auto]

Select [Auto] to automatically detect an IDE hard disk drive. If automatic detection is successful, the correct values will be filled in for the remaining fields on this sub-menu. If automatic detection fails, your hard disk drive may be too old or too new. You can try updating your BIOS or enter the IDE hard disk drive parameters manually.

NOTE: After the IDE hard disk drive information has been entered into BIOS, new IDE hard disk drives must be partitioned (such as with FDISK) and then formatted before data can be read from and write on. Primary IDE hard disk drives must have its partition set to *active* (also possible with FDISK).

Other options for the **Type** field are:

[None] - to disable IDE devices

4. BIOS SETUP

IMPORTANT: If your hard disk was already formatted on an older previous system, incorrect parameters may be detected. You will need to enter the correct parameters manually or use low-level format if you do not need the data stored on the hard disk. If the parameters listed differ from the ones used when the disk was formatted, the disk will not be readable. If the auto-detected parameters do not match the ones that should be used for your disk, you should enter the correct ones manually by setting [User Type HDD].

[User Type HDD]

AwardBIOS Setup Utility		
Main		
Primary Master [User Type HDD]	Item Specific Help	
Type	[User Type HDD]	<Enter> to select the type of the IDE drive. [User Type HDD] allows you to set each entry on your own.
Translation Method	[LBA]	
Cylinders	[1023]	
Head	[64]	
Sector	[63]	
CHS Capacity	2111MB	
Maximum LBA Capacity	2111MB	
Multi-Sector Transfers	[Maximum]	
SMART Monitoring	[Disabled]	
PIO Mode	[4]	
ULTRA DMA Mode	[Disabled]	
F1 Help ↑↓ Select Item -/+ Change Values F5 Setup Defaults		
ESC Exit ↔ Select Menu Enter Select Sub-Menu F10 Save and Exit		

Manually enter the number of cylinders, heads and sectors per track for your drive. Refer to your drive documentation or look on the drive for this information. If no drive is installed or if you are removing a drive and not replacing it, select [None].

Translation Method [LBA]

Select the hard disk drive type in this field. When Logical Block Addressing is enabled, 28-bit addressing of the hard drive is used without regard for cylinders, heads, or sectors. Note that Logical Block Access may decrease the access speed of the hard disk. However, LBA Mode is necessary for drives with greater than 504MB in storage capacity. Configuration options: [LBA] [LARGE] [Normal] [Match Partition Table] [Manual]

Cylinders

This field configures the number of cylinders. Refer to your drive documentation to determine the correct value to enter into this field. **NOTE:** To make changes to this field, the **Type** field must be set to [User Type HDD] and the **Translation Method** field must be set to [Manual].

4. BIOS SETUP

Head

This field configures the number of read/write heads. Refer to your drive documentation to determine the correct value to enter into this field. **NOTE:** To make changes to this field, the **Type** field must be set to [User Type HDD] and the **Translation Method** field must be set to [Manual].

Sector

This field configures the number of sectors per track. Refer to your drive documentation to determine the correct value to enter into this field. **NOTE:** To make changes to this field, the **Type** field must be set to [User Type HDD] and the **Translation Method** field must be set to [Manual].

CHS Capacity

This field shows the drive's maximum CHS capacity calculated automatically by the BIOS from the drive information you entered.

Maximum LBA Capacity

This field shows the drive's maximum LBA capacity calculated automatically by the BIOS from the drive information you entered.

Multi-Sector Transfers [Maximum]

This option automatically sets the number of sectors per block to the highest number supported by the drive. This field can also be configured manually. Note that when this field is automatically configured, the set value may not always be the fastest value for the drive. Refer to the documentation that came with your hard drive to determine the optimal value and set it manually. **NOTE:** To make changes to this field, the **Type** field must be set to [User Type HDD]. Configuration options: [Disabled] [2 Sectors] [4 Sectors] [8 Sectors] [16 Sectors] [32 Sectors] [Maximum]

SMART Monitoring [Disabled]

This allows the enabling or disabling of the S.M.A.R.T. (Self-Monitoring, Analysis and Reporting Technology) system which utilizes internal hard disk drive monitoring technology. This feature is normally disabled because system resources used in this feature may decrease system performance. Configuration options: [Disabled] [Enabled]

PIO Mode [4]

This option lets you set a PIO (Programmed Input/Output) mode for the IDE device. Modes 0 through 4 provide successively increased performance. Configuration options: [0] [1] [2] [3] [4]

Ultra DMA Mode [Disabled]

Ultra DMA capability allows improved transfer speeds and data integrity for compatible IDE devices. Set to [Disabled] to suppress Ultra DMA capability. **NOTE:** To make changes to this field, the **Type** field must be set to [User Type HDD]. Configuration options: [0] [1] [2] [3] [4] [Disabled]

4. BIOS SETUP

Other options for “Type:” are:

[CD-ROM] - for IDE CD-ROM drives

[LS-120] - for LS-120 compatible floppy disk drives

[ZIP-100] - for ZIP-100 compatible disk drives

[MO] - for IDE magneto optical disk drives

[Other ATAPI Device] - for IDE devices not listed here

After using the legend keys to make your selections on this sub-menu, press the <Esc> key to exit back to the Main menu. When the Main menu appears, you will notice that the drive size appear in the field for the hard disk drive that you just configured.

Language [English]

This allows selection of the BIOS' displayed language. Currently only English is available.

Supervisor Password [Disabled], User Password [Disabled]

These fields allow you to set the passwords. To set any of the passwords, highlight the appropriate field and press <Enter>.

Type in a password and press <Enter>. You can type up to eight alphanumeric characters. Symbols and other keys are ignored. To confirm the password, type the password again and press the <Enter>. The password is now set to [Enabled]. This password allows full access to the BIOS Setup menus.

To clear the password, highlight this field and press <Enter>. The same dialog box as above will appear. Press <Enter> and the password will be set to [Disabled].

A Note about Passwords

The BIOS Setup program allows you to specify passwords in the Main menu. The passwords control access to the BIOS during system startup. The passwords are not case sensitive. In other words, it makes no difference whether you enter a password using upper or lowercase letters.

The BIOS Setup program allows you to specify two separate passwords: a Supervisor password and a User password. When disabled, anyone may access all BIOS Setup program functions. When enabled, the Supervisor password is required for entering the BIOS Setup program and having full access to all Security menu options.

4. BIOS SETUP

Forgot the password?

If you forgot the password, you can clear the password by erasing the CMOS Real Time Clock (RTC) RAM. The RAM data containing the password information is powered by the onboard button cell battery. To erase the RTC RAM: (1) Unplug your computer, (2) Short the solder points, (3) Turn ON your computer, (4) Hold down <Delete> during bootup and enter BIOS setup to re-enter user preferences.

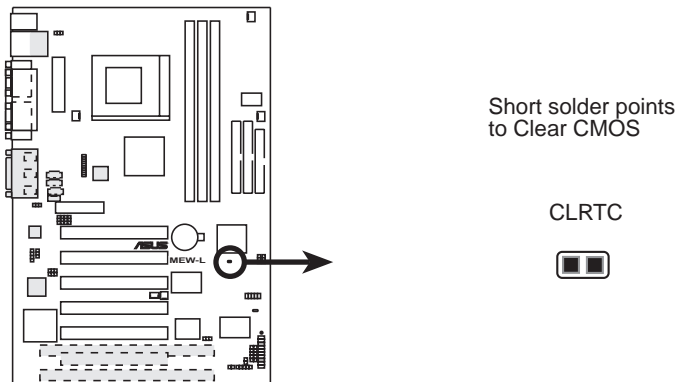

MEW-L Clear RTC RAM

Halt On [All Errors]

This field determines which types of errors will cause the system to halt. Configuration options: [All Errors] [No Error] [All but Keyboard] [All but Disk] [All but Disk/Keyboard]

Installed Memory [XXX MB]

This field displays the amount of conventional memory detected by the system during bootup. You do not need to make changes to this field. This is a display only field.

4. BIOS SETUP

4.4 Advanced Menu

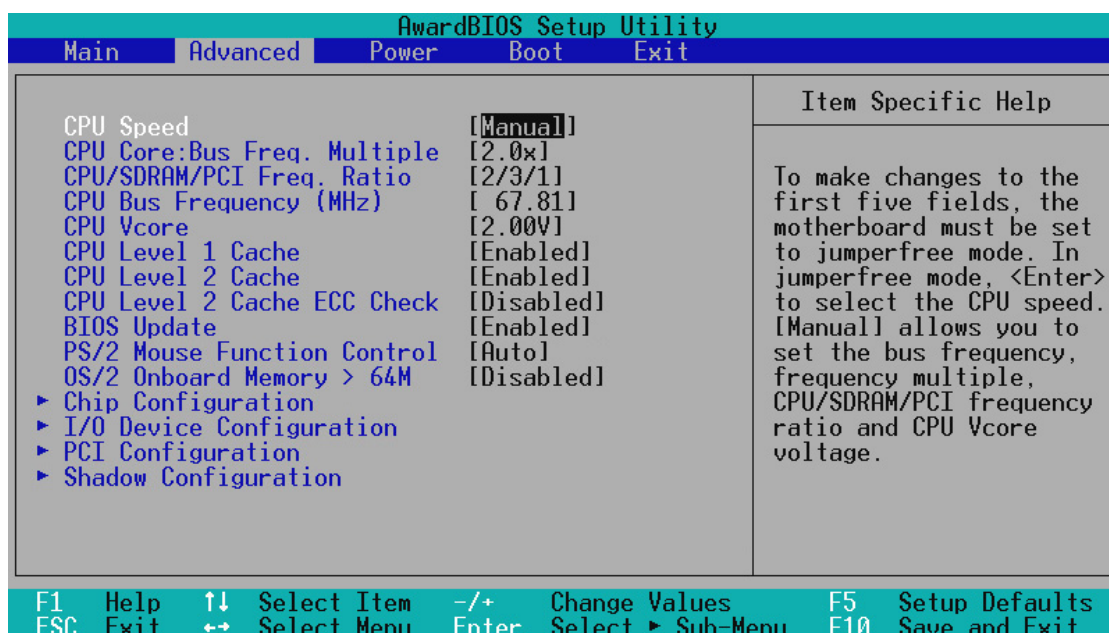

CPU Speed [Manual]

When the motherboard is set to JumperFree™ mode, this field allows you to select the internal speed of your CPU. Select [Manual] if you want to make changes to the subsequent four fields. Configuration options: [Manual] [266MHz] [300MHz] [333MHz] [366MHz] [400MHz] [433MHz] [466MHz]

CPU Core:Bus Freq. Multiple (when CPU Speed is set to [Manual])

This field is for unlocked processors only. If your socket 370 processor's Frequency Multiple is locked, setting the Frequency Multiple here will have no effect. This field sets the frequency multiple between the CPU's *internal* frequency and *external* frequency. This must be set in conjunction with **CPU Bus Frequency** to match the speed of your CPU. Configuration options: [2.0x] [2.5x] [3.0x]...[7.0x] [7.5x] [8.0x]

CPU/SDRAM/PCI Freq. Ratio (when CPU Speed is set to [Manual])

This field determines whether the memory clock frequency is set to be in synchronous or asynchronous mode with respect to the **CPU Bus Frequency**. Each of the two memory data transfer methods leads to a set of 16 CPU Bus Frequency selections. Configuration options: [2/3/1] [3/3/1]

CPU Bus Frequency (MHz) (when CPU Speed is set to [Manual])

This feature tells the clock generator what frequency to send to the CPU, DRAM, and chipset. The bus frequency (external frequency) multiplied by the bus multiple equals the CPU's internal frequency (the **CPU speed**). The configuration options vary depending on the **CPU/SDRAM/PCI Frequency Ratio**.

4. BIOS SETUP

CPU Vcore (when CPU Speed is set to [Manual])

This field displays the core voltage supplied to the CPU. If you want to set it manually, always refer to the CPU documentation for the reasonable voltage range. Configuration options: [2.40V] [2.30V] [2.20V] [2.10V] [2.05V] [2.00V]

CPU Level 1 Cache, CPU Level 2 Cache [Enabled]

These fields allow you to choose from the default of [Enabled] or choose [Disabled] to turn ON or OFF the CPU's Level 1 and Level 2 built-in cache. Configuration options: [Disabled] [Enabled]

CPU Level 2 Cache ECC Check [Disabled]

This function controls the ECC capability in the CPU level 2 cache. Configuration options: [Disabled] [Enabled]

BIOS Update [Enabled]

This functions as an update loader integrated into the BIOS to supply the processor with the required data. In the default position of [Enabled], the BIOS will load the update on all processors during system bootup. Configuration options: [Disabled] [Enabled]

PS/2 Mouse Function Control [Auto]

The default of [Auto] allows the system to detect a PS/2 mouse on startup. If detected, IRQ12 will be used for the PS/2 mouse. IRQ12 will be reserved for expansion cards only if a PS/2 mouse is not detected. [Enabled] will always reserve IRQ12, whether on startup a PS/2 mouse is detected or not. Configuration options: [Enabled] [Auto]

OS/2 Onboard Memory > 64M [Disabled]

When using OS/2 operating systems with installed DRAM of greater than 64MB, you need to set this option to [Enabled]; otherwise, leave this on [Disabled]. Configuration options: [Disabled] [Enabled]

4. BIOS SETUP

4.4.1 Chip Configuration

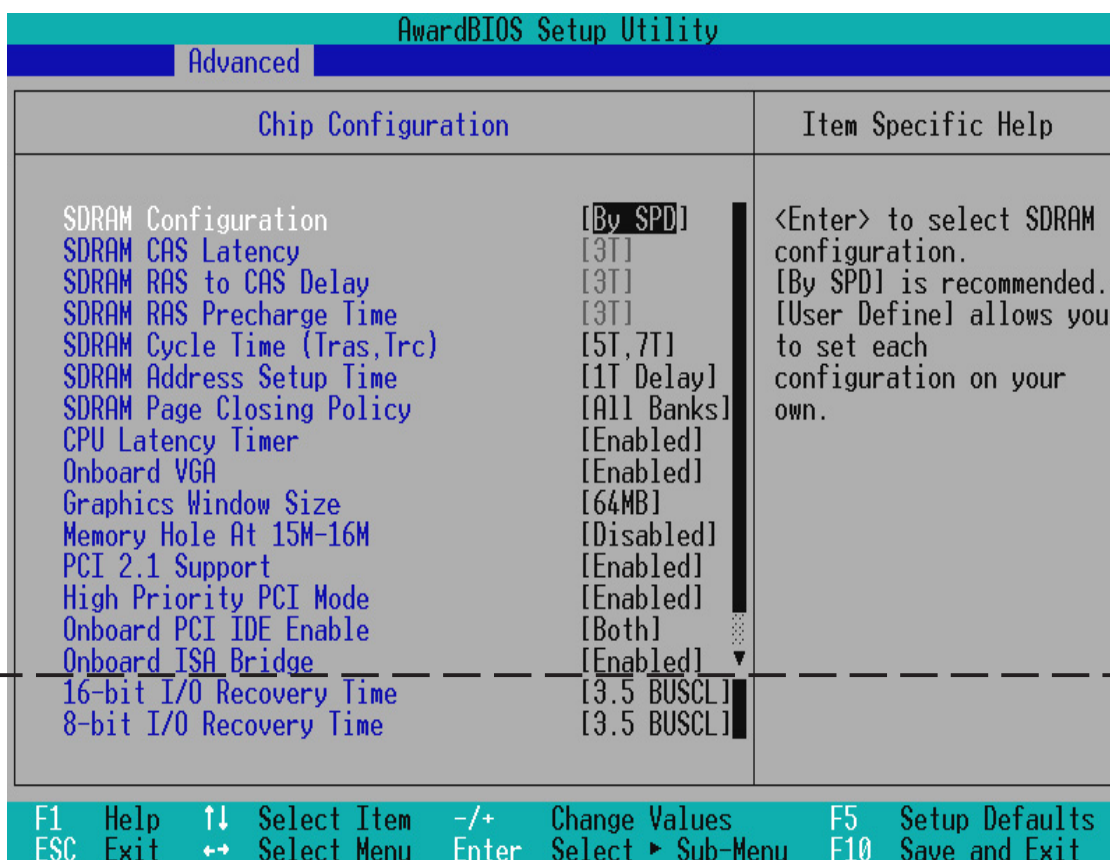

(scroll down to see more items, as shown here)

SDRAM Configuration [By SPD]

This sets the optimal timings for items 2–4, depending on the memory modules that you are using. Default setting is [By SPD], which configures items 2–4 by reading the contents in the SPD (Serial Presence Detect) device. The EEPROM on the memory module stores critical parameter information about the module, such as memory type, size, speed, voltage interface, and module banks. Configuration options: [User Define] [7ns (143MHz)] [8ns (125MHz)] [By SPD]

SDRAM CAS Latency

This controls the latency between the SDRAM read command and the time that the data actually becomes available. **NOTE:** To make changes to this field, the **SDRAM Configuration** field must be set to [User Define].

SDRAM RAS to CAS Delay

This controls the latency between the SDRAM active command and the read/write command. **NOTE:** To make changes to this field, the **SDRAM Configuration** field must be set to [User Define].

4. BIOS SETUP

SDRAM RAS Precharge Time

This controls the idle clocks after issuing a precharge command to the SDRAM. **NOTE:** To make changes to this field, the **SDRAM Configuration** field must be set to [User Define].

SDRAM Cycle Time (Tras, Trc) [5T, 7T]

This feature controls the number of SDRAM clocks used per access cycle. Configuration options: [5T, 7T] [6T, 8T]

SDRAM Address Setup Time [1T Delay]

Configuration options: [No Delay] [1T Delay]

SDRAM Page Closing Policy [All Banks]

This feature controls whether the graphic and memory controller hub will precharge one or all banks after a page miss. Configuration options: [One Bank] [All Banks]

CPU Latency Timer [Enabled]

Configuration options: [Disabled] [Enabled]

Onboard VGA [Enabled]

Leave on default setting if you want to use the onboard VGA. If this field is disabled, all **Display Cache** configurations will not be available. Configuration options: [Disabled] [Enabled]

Graphics Window Size [64MB]

This feature allows you to select the size of mapped memory for AGP graphic data. Configuration options: [64MB] [32MB]

Memory Hole At 15M-16M [Disabled]

This field allows you to reserve an address space for ISA expansion cards that require it. Configuration options: [Disabled] [Enabled]

PCI 2.1 Support [Enabled]

This function allows you to enable or disable PCI 2.1 features including passive release and delayed transaction. Configuration options: [Disabled] [Enabled]

High Priority PCI Mode [Enabled]

This field allows you to give PCI slot 1 a higher priority. You may want to leave on the default setting if you are using an IEEE-1394 PCI card. Configuration options: [Disabled] [Enabled]

Onboard PCI IDE Enable [Both]

You can select to enable the primary IDE channel, secondary IDE channel, both, or disable both channels. Configuration options: [Both] [Primary] [Secondary] [Disabled]

4. BIOS SETUP

Onboard ISA Bridge [Enabled]

If you are not using any ISA cards, you may disable this field. When this field is disabled, the **8-bit** and **16-bit I/O Recovery Time** configurations will not be available. Configuration options: [Disabled] [Enabled]

8-bit, 16-bit I/O Recovery Time [3.5 BUSCLK]

Leave on default setting.

4. BIOS SETUP

4.4.2 I/O Device Configuration

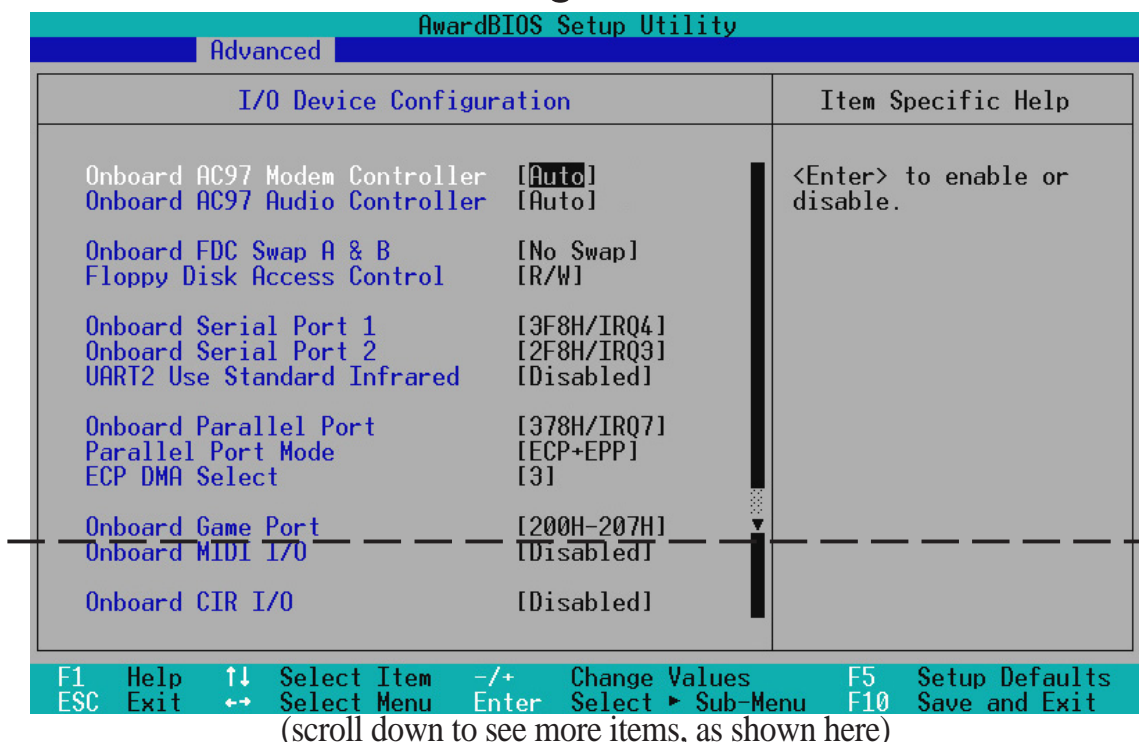

Onboard AC97 Modem Controller, Audio Controller [Auto]

[Auto] allows the motherboard's BIOS to detect whether you are using any modem/audio device. If a modem/audio device is detected, the onboard modem/audio controller will be enabled; if no modem/audio device is detected, the onboard modem/audio controller will be disabled. If you have conflicts with the onboard modem/audio controller, you may set the appropriate field to [Disabled]. Configuration options: [Auto] [Disabled]

Onboard FDC Swap A & B [No Swap]

This field allows you to reverse the hardware drive letter assignments of your floppy disk drives. Configuration options: [No Swap] [Swap AB]

Floppy Disk Access Control [R/W]

When set to [Read Only], this field protects files from being copied to floppy disks by allowing reads from the floppy disk drive but not writes. The setup default [R/W] allows both reads and writes. Configuration options: [R/W] [Read Only]

Onboard Serial Port 1 [3F8H/IRQ4], Onboard Serial Port 2 [2F8H/IRQ3]

These fields allow you to set the addresses for the onboard serial connectors. Serial Port 1 and Serial Port 2 must have different addresses. Configuration options: [3F8H/IRQ4] [2F8H/IRQ3] [3E8H/IRQ4] [2E8H/IRQ10] [Disabled]

4. BIOS SETUP

UART2 Use Standard Infrared [Disabled]

When enabled, this field activates the onboard standard infrared feature and sets the second serial UART to support the infrared module connector on the motherboard. If your system already has a second serial port connected to the onboard COM2 connector, it will no longer work if you enable the infrared feature. See **IrDA-Compliant Infrared Module Connector** in *3.8 External Connectors*. Configuration options: [Disabled] [Enabled]

Onboard Parallel Port [378H/IRQ7]

This field sets the address of the onboard parallel port connector. If you disable this feature, **Parallel Port Mode** and **ECP DMA Select** configurations will not be available. Configuration options: [Disabled] [3BCH/IRQ7] [378H/IRQ7] [278H/IRQ5]

Parallel Port Mode [ECP+EPP]

This field allows you to set the operation mode of the parallel port. [Normal] allows normal-speed operation but in one direction only; [EPP] allows bidirectional parallel port operation; [ECP] allows the parallel port to operate in bidirectional DMA mode; [ECP+EPP] allows normal speed operation in a two-way mode. Configuration options: [Normal] [EPP] [ECP] [ECP+EPP]

ECP DMA Select [3]

This field allows you to configure the parallel port DMA channel for the selected **ECP** mode. This selection is available only if you select [ECP] or [ECP+EPP] in **Parallel Port Mode** above. Configuration options: [1] [3] [Disabled]

Onboard Game Port [200H-207H]

This field sets the address of the onboard game port connector. Configuration options: [Disabled] [200H-207H] [208H-20FH]

Onboard MIDI I/O [Disabled]

This field sets the address of the onboard MIDI connector. Configuration options: [Disabled] [330H-331H] [300H-301H]

Onboard MIDI IRQ [xx]

This field is not available if you select [Disabled] in **Onboard MIDI I/O**. Configuration options: [3] [4] [5] [7] [9] [10] [11] [12] [14] [15]

Onboard CIR I/O [Disabled]

This field sets the address of the onboard Consumer IR connector. Configuration options: [Disabled] [2E0-2E8H] [3E0-3E8H]

Onboard CIR IRQ [xx]

This field is not available if you select [Disabled] in **Onboard CIR I/O**. Configuration options: [3] [4] [5] [7] [9] [10] [11] [12] [14] [15]

4. BIOS SETUP

4.4.3 PCI Configuration

AwardBIOS Setup Utility		
Advanced		
PCI Configuration	Item Specific Help	
Slot 1/5 IRQ	[Auto]	<Enter> to select an IRQ.
Slot 2 IRQ	[Auto]	
Slot 3 IRQ	[Auto]	
Slot 4 IRQ	[Auto]	
PCI/VGA Palette Snoop	[Disabled]	
PCI Latency Timer	[32]	
SYMBIOS SCSI BIOS	[Auto]	
USB Function	[Enabled]	
ONB VGA BIOS First	[No]	
▶ PCI/PNP ISA IRQ Resource Exclusion		
▶ PCI/PNP ISA DMA Resource Exclusion		
▶ PCI/PNP ISA UMB Resource Exclusion		

F1 Help ↑↓ Select Item -/+ Change Values F5 Setup Defaults
ESC Exit ↔ Select Menu Enter Select ▶ Sub-Menu F10 Save and Exit

Slot 1/5, Slot 2, Slot 3, Slot 4 IRQ [Auto]

These fields set how IRQ use is determined for each PCI slot. The default setting for each field is [Auto], which uses auto-routing to determine IRQ use. Configuration options: [Auto] [NA] [3] [4] [5] [7] [9] [10] [11] [12] [14] [15]

PCI/VGA Palette Snoop [Disabled]

Some nonstandard VGA cards, such as graphics accelerators or MPEG Video Cards, may not show colors properly. The setting [Enabled] should correct this problem. Otherwise, leave this on the default setting of [Disabled]. Configuration options: [Disabled] [Enabled]

PCI Latency Timer [32]

Leave on default setting for best performance vs. stability.

SYMBIOS SCSI BIOS [Auto]

[Auto] allows the motherboard's BIOS to detect whether you have a Symbios SCSI card. If the Symbios SCSI card is detected, the motherboard's Symbios BIOS will be enabled; if no Symbios SCSI card is detected, the onboard Symbios SCSI BIOS will be disabled.

[Disabled] will disable the motherboard's Symbios SCSI BIOS so that the BIOS on an external Symbios SCSI card can be used. If your Symbios SCSI card does not have a BIOS, the Symbios SCSI card will not function. Configuration options: [Auto] [Disabled]

4. BIOS SETUP

USB Function [Enabled]

This motherboard supports Universal Serial Bus (USB) devices. Set to [Enabled] if you want to use USB devices. Configuration options: [Disabled] [Enabled]

ONB VGA BIOS First [No]

This field, when set to [Yes], gives priority to the onboard VGA BIOS over other VGA controllers. Configuration options: [No] [Yes]

PCI/PNP ISA IRQ Resource Exclusion

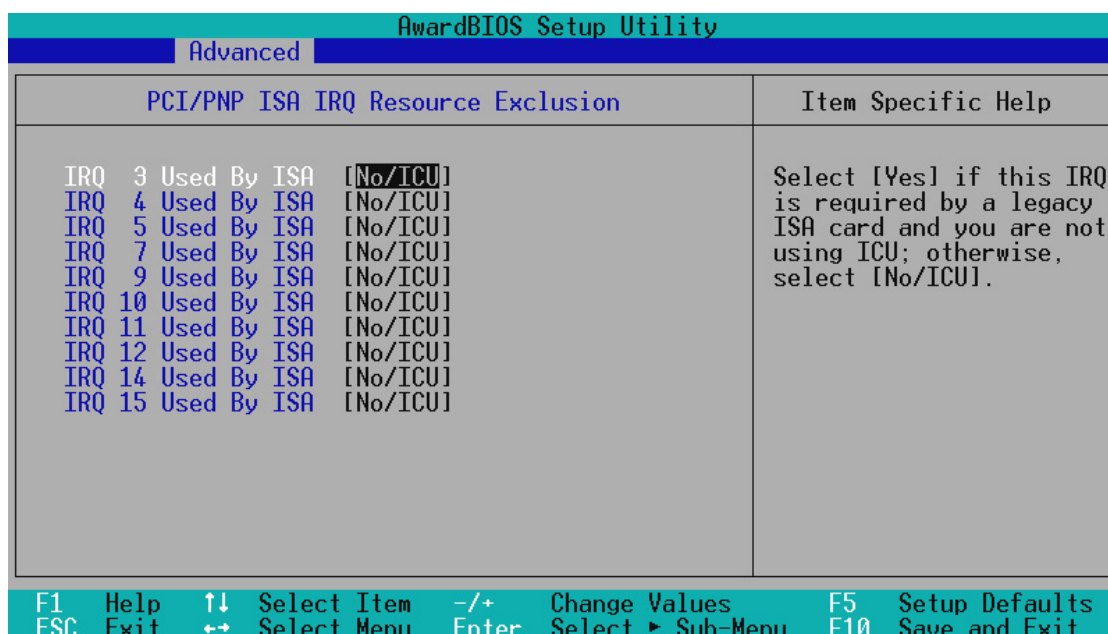

The screenshot shows the 'AwardBIOS Setup Utility' interface. At the top, it says 'Advanced'. The main menu is 'PCI/PNP ISA IRQ Resource Exclusion'. Below this, there is a list of IRQs and their status:

IRQ	Used By	ISA	[No/ICU]
IRQ 3	Used By	ISA	[No/ICU]
IRQ 4	Used By	ISA	[No/ICU]
IRQ 5	Used By	ISA	[No/ICU]
IRQ 7	Used By	ISA	[No/ICU]
IRQ 9	Used By	ISA	[No/ICU]
IRQ 10	Used By	ISA	[No/ICU]
IRQ 11	Used By	ISA	[No/ICU]
IRQ 12	Used By	ISA	[No/ICU]
IRQ 14	Used By	ISA	[No/ICU]
IRQ 15	Used By	ISA	[No/ICU]

Item Specific Help: Select [Yes] if this IRQ is required by a legacy ISA card and you are not using ICU; otherwise, select [No/ICU].

Navigation keys: F1 Help, ESC Exit, ↑↓ Select Item, ↔ Select Menu, -/+ Change Values, Enter Select ► Sub-Menu, F5 Setup Defaults, F10 Save and Exit.

IRQ XX Used By ISA [No/ICU]

These fields indicate whether or not the displayed IRQ for each field is being used by a legacy (non-PnP) ISA card. The default value indicates either that the displayed IRQ is not used or that ISA Configuration Utility (ICU) is being used to determine if an ISA card is using that IRQ. If you install a legacy ISA card that requires a unique IRQ and you are not using an ICU, you must set the field for that IRQ to [Yes]. For example: If you install a legacy ISA card that requires IRQ 10, then set **IRQ10 Used By ISA** to [Yes]. Configuration options: [No/ICU] [Yes]

4. BIOS SETUP

PCI/PNP ISA DMA Resource Exclusion

AwardBIOS Setup Utility	
Advanced	
PCI/PNP ISA DMA Resource Exclusion	Item Specific Help
DMA 1 Used By ISA [No/ICU]	Select [Yes] if this DMA channel is required by a legacy ISA card and you are not using ICU; otherwise, select [No/ICU].
DMA 3 Used By ISA [No/ICU]	
DMA 5 Used By ISA [No/ICU]	
F1 Help ↑↓ Select Item -/+ Change Values F5 Setup Defaults ESC Exit ↔ Select Menu Enter Select ► Sub-Menu F10 Save and Exit	

DMA x Used By ISA [No/ICU]

These fields indicate whether or not the displayed DMA channel for each field is being used by a legacy (non-PnP) ISA card. The default setting indicates either that the displayed DMA channel is not used or an ICU is being used to determine if an ISA card is using that channel. If you install a legacy ISA card that requires a unique DMA channel, and you are not using an ICU, you must set the field for that channel to [Yes]. Configuration options: [No/ICU] [Yes]

PCI/PNP ISA UMB Resource Exclusion

AwardBIOS Setup Utility	
Advanced	
PCI/PNP ISA UMB Resource Exclusion	Item Specific Help
ISA MEM Block BASE [No/ICU]	This is for some ISA add-on cards whose UMB can't be auto-detected.
F1 Help ↑↓ Select Item -/+ Change Values F5 Setup Defaults ESC Exit ↔ Select Menu Enter Select ► Sub-Menu F10 Save and Exit	

4. BIOS SETUP

ISA MEM Block BASE [No/ICU]

This field allows you to set the base address and block size of a legacy ISA card that uses any memory segment within the C800 and DFFF address range. If you have such a card and you are not using an ICU to specify its address range, select a base address from the six available options; the **ISA MEM Block SIZE** field will then appear for selecting the block size. If you have more than one legacy ISA card in your system that requires the use of this address range, you can increase the block size to 8K, 16K, 32K, or 64K. If you are using an ICU to accomplish this task, leave **ISA MEM Block BASE** to its default setting of [No/ICU]. Configuration options: [No/ICU] [C800] [CC00] [D000] [D400] [D800] [DC00]

4.4.4 Shadow Configuration

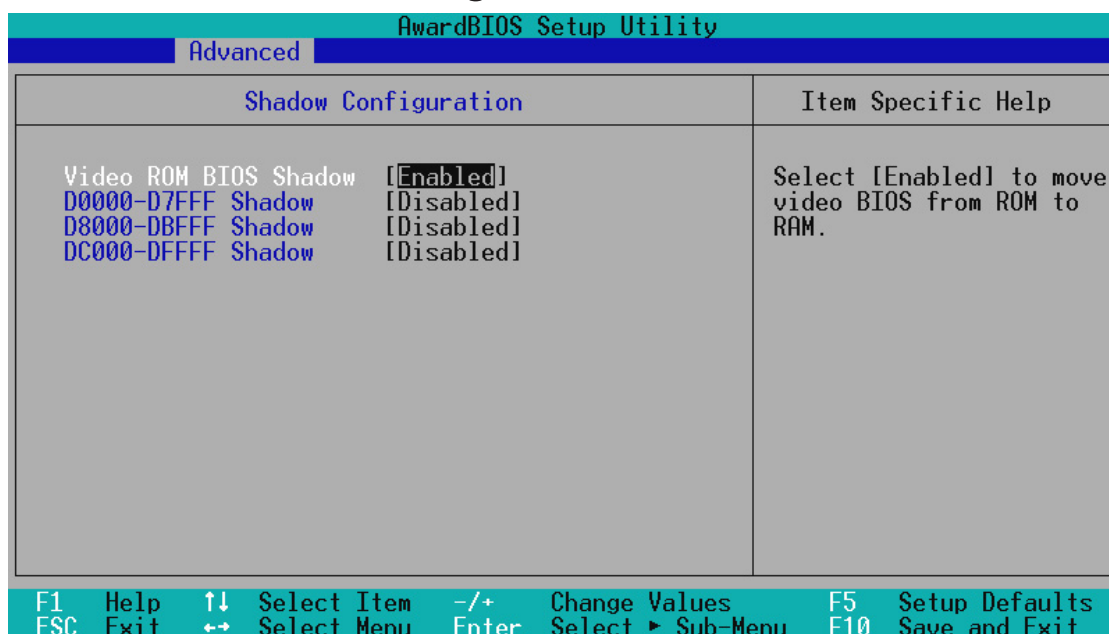

Video ROM BIOS Shadow [Enabled]

This field allows you to change the video BIOS location from ROM to RAM. Relocating to RAM enhances system performance, as information access is faster than the ROM. Configuration options: [Disabled] [Enabled]

D0000-DFFFF Shadow [Disabled]

These fields are used for shadowing other expansion card ROMs. If you install other expansion cards with ROMs on them, you will need to know which addresses the ROMs use to shadow them specifically. Shadowing a ROM reduces the memory available between 640K and 1024K by the amount used for this purpose. Configuration options: [Disabled] [Enabled]

4. BIOS SETUP

4.5 Power Menu

The Power menu allows you to reduce power consumption. This feature turns OFF the video display and shuts down the hard disk after a period of inactivity.

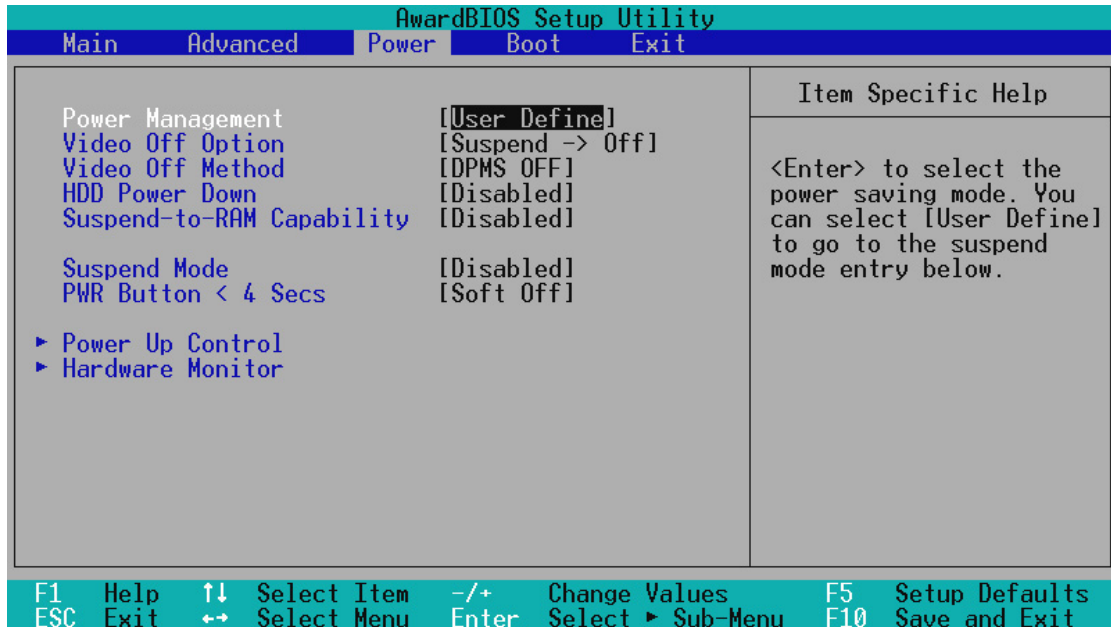

Power Management [User Define]

This option must be enabled to use any of the automatic power saving features. If this menu item is set to [Disabled], power management features will not function regardless of other field settings on this menu. The [User Define] option allows you to make your own selections in the Power menu. When set to [Max Saving], system power will be conserved to its greatest amount. The **Suspend Mode** field will then be set to predefined value that ensures maximum power savings.

This field acts as the master control for the power management modes. [Max Saving] puts the system into power saving mode after a brief period of system inactivity; [Min Saving] is almost the same as [Max Saving] except that the system inactivity period is longer; [Disabled] disables the power saving features; [User Define] allows you to set power saving options according to your preference. Configuration options: [User Define] [Disabled] [Min Saving] [Max Saving]

IMPORTANT: Advanced Power Management (APM) should be installed to keep the system time updated when the computer enters suspend mode activated by the BIOS Power Management. For DOS environments, you need to add the statement, DEVICE=C:\DOS\POWER.EXE, to your CONFIG.SYS file. For Windows 3.x and Windows 95, you need to install Windows with the APM feature. For Windows 98 and later, APM is automatically installed. A battery and power cord icon labeled “Power Management” will appear in the “Control Panel.” Choose “Advanced” in the Power Management Properties dialog box.

4. BIOS SETUP

Video Off Option [Suspend -> Off]

This field determines when to activate the video OFF feature for monitor power management. Configuration options: [Always On] [Suspend -> Off]

Video Off Method [DPMS OFF]

This field defines the video OFF features. The DPMS (Display Power Management System) feature allows the BIOS to control the video display card if it supports the DPMS feature. [Blank Screen] only blanks the screen (use this for monitors without power management or “green” features. If set up in your system, your screen saver will not display with [Blank Screen] selected). [V/H SYNC+Blank] blanks the screen and turns OFF vertical and horizontal scanning. Configuration options: [Blank Screen] [V/H SYNC+Blank] [DPMS Standby] [DPMS Suspend] [DPMS OFF] [DPMS Reduce ON]

HDD Power Down [Disabled]

Shuts down any IDE hard disk drives in the system after a period of inactivity as set in this user-configurable field. This feature does not affect SCSI hard drives. Configuration options: [Disabled] [1 Min] [2 Min] [3 Min]...[15 Min]

Suspend-to-RAM Capability [Disabled]

Suspend-to-RAM (STR) is an energy-saving feature. In Suspend-to-RAM state, all devices on the computer are turned OFF, except for the system RAM. Thus, the PC consumes less than 5 Watts of power. [Auto] allows the BIOS to detect if your power supply can supply at least 720mA on the +5VSB lead to support the STR function. If the power supply meets the requirement, the STR function will be enabled; if not, this function will be disabled. If the expansion cards you use on the motherboard do not support the STR function, you must leave this field on the default setting [Disabled]. Configuration options: [Auto] [Disabled]

Suspend Mode [Disabled]

Sets the time period before the system goes into suspend mode. Configuration options: [Disabled] [1~2 Min] [2~3 Min] [4~5 Min] [8~9 Min] [20 Min]...[1 Hour]

PWR Button < 4 Secs [Soft off]

When set to [Soft off], the ATX switch can be used as a normal system power-OFF button when pressed for less than 4 seconds. [Suspend] allows the button to have a dual function where pressing less than 4 seconds will place the system in sleep mode. Regardless of the setting, holding the ATX switch for more than 4 seconds will power OFF the system. Configuration options: [Soft off] [Suspend]

4. BIOS SETUP

4.5.1 Power Up Control

AwardBIOS Setup Utility	
Power	
Power Up Control	Item Specific Help
AC PWR Loss Restart [Disabled]	<Enter> to select whether or not to restart the system after AC power loss.
PWR Up On Modem Act [Disabled]	
Wake On LAN [Disabled]	
Wake On PS2 KB/Mouse [Disabled]	
Automatic Power Up [Disabled]	

F1 Help ↑↓ Select Item -/+ Change Values F5 Setup Defaults
ESC Exit ↔ Select Menu Enter Select ▶ Sub-Menu F10 Save and Exit

AC PWR Loss Restart [Disabled]

This allows you to set whether you want your system to reboot after the power has been interrupted. [Disabled] leaves your system OFF and [Enabled] reboots your system. Configuration options: [Disabled] [Enabled]

PWR Up On Modem Act [Disabled]

This allows either settings of [Enabled] or [Disabled] for powering up the computer when the modem receives a call while the computer is in Soft-off mode. **NOTE:** The computer cannot receive or transmit data until the computer and applications are fully running, thus connection cannot be made on the first try. Turning an external modem OFF and then back ON while the computer is OFF causes an initialization string that will also cause the system to power ON. Configuration options: [Disabled] [Enabled]

Wake On LAN [Enabled]

Wake-On-LAN allows your computer to be booted from another computer via a network by sending a wake-up frame or signal. Configuration options: [Disabled] [Enabled]

IMPORTANT: This feature requires an optional network interface with Wake-On-LAN and an ATX power supply with at least 720mA +5V standby power.

4. BIOS SETUP

Wake On PS2 KB/Mouse [Disabled]

Set this field to [Enabled] if you wish to use your PS2 keyboard (by pressing the spacebar) or PS2 mouse (by clicking on the left button) to power up your computer. This feature requires an ATX power supply that can supply at least 300mA on the +5VSB lead. The default is set to [Disabled] because not all computers have the appropriate ATX power supply. Your computer will not power ON if you set this to [Enabled] and do not have the appropriate ATX power supply. Configuration options: [Disabled] [Enabled]

Automatic Power Up [Disabled]

This allows an unattended or automatic system power up. You may configure your system to power up at a certain time of the day by selecting [Everyday] or at a certain time and day by selecting [By Date]. Configuration options: [Disabled] [Everyday] [By Date]

4. BIOS SETUP

4.5.2 Hardware Monitor

AwardBIOS Setup Utility		
Power		
HardWare Monitor	Item Specific Help	
MB Temperature	33°C/91°F	<Enter> to switch between monitoring or ignoring.
CPU Temperature	61°C/141°F	
CPU Fan Speed	4560RPM	
Power Fan Speed	N/A	
Chassis Fan Speed	N/A	
VCORE Voltage	2.0V	
+3.3V Voltage	3.3V	
+5V Voltage	5.0V	
+12V Voltage	12.0V	
-12V Voltage	-12.0V	
-5V Voltage	- 5.0V	

F1 Help ↑↓ Select Item -/+ Change Values F5 Setup Defaults
ESC Exit ↔ Select Menu Enter Select ► Sub-Menu F10 Save and Exit

MB Temperature, CPU Temperature [xxxC/xxxF]

The onboard hardware monitor is able to detect the MB (motherboard) and CPU temperatures. Set to [Ignore] only if necessary.

CPU Fan, Power Fan, Chassis Fan Speed [xxxxRPM]

The onboard hardware monitor is able to detect the CPU fan speed, power supply fan speed, and the chassis fan speed in rotations per minute (RPM). The presence of the fans is automatically detected. Set to [Ignore] only if necessary.

VCORE Voltage, +3.3V Voltage, +5V Voltage, +12V Voltage, -12V Voltage, -5V Voltage [xx.xV]

The onboard hardware monitor is able to detect the voltage output by the onboard voltage regulators. Set to [Ignore] only if necessary.

NOTE: If any of the monitored items is out of range, an error message will appear: “Hardware Monitor found an error. Enter Power setup menu for details”. You will then be prompted to “Press **F1** to continue, **DEL** to enter SETUP”.

4. BIOS SETUP

4.6 Boot Menu

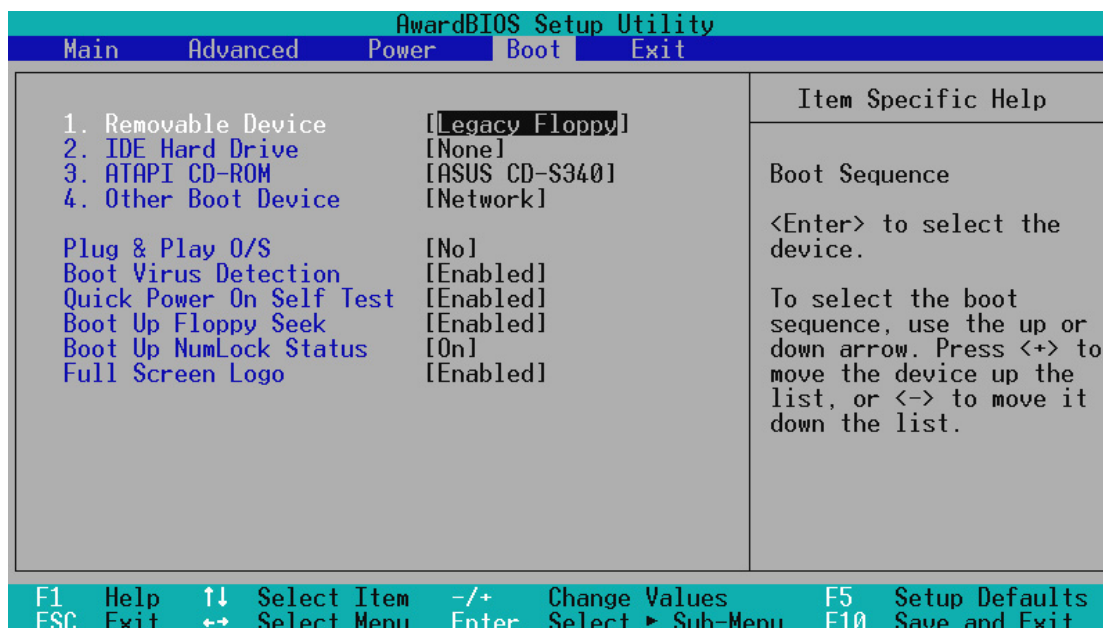

Boot Sequence

The Boot menu allows you to select among the four possible types of boot devices listed using the up and down arrow keys. By using the <+> or <Space> key, you can promote devices and by using the <-> key, you can demote devices. Promotion or demotion of devices alters the priority which the system uses to search for a boot device on system power up. Configuration options: [Removable Devices] [IDE Hard Drive] [ATAPI CD-ROM] [Other Boot Device]

Removable Device [Legacy Floppy]

Configuration options: [Disabled] [Legacy Floppy] [LS120] [ZIP-100] [ATAPI MO]

IDE Hard Drive

This field allows you to select which IDE hard disk drive to use in the boot sequence. Pressing [Enter] will show the product IDs of all connected IDE hard disk drives or allow you to disable this field.

ATAPI CD-ROM

This field allows you to select which ATAPI CD-ROM drive to use in the boot sequence. Pressing [Enter] will show the product IDs of all your connected ATAPI CD-ROM drives or allow you to disable this field.

Other Boot Device Select [Network]

Configuration options: [Disabled] [Network] [SCSI Boot Device]

4. BIOS SETUP

Plug & Play O/S [No]

This field allows you to use a Plug-and-Play (PnP) operating system to configure the PCI bus slots instead of using the BIOS. When [Yes] is selected, interrupts may be reassigned by the OS. When a non-PnP OS is installed or you want to prevent reassigning of interrupt settings, select the default setting of [No]. Configuration options: [No] [Yes]

Boot Virus Detection [Enabled]

Configuration options: [Disabled] [Enabled]

Quick Power On Self Test [Enabled]

Configuration options: [Disabled] [Enabled]

Boot Up Floppy Seek [Enabled]

Configuration options: [Disabled] [Enabled]

Boot Up NumLock Status [On]

Configuration options: [Off] [On]

Full Screen Logo [Enabled]

Configuration options: [Disabled] [Enabled]

4. BIOS SETUP

4.7 Exit Menu

Once you have made all of your selections from the various menus in the Setup program, you should save your changes and exit Setup. Select **Exit** from the menu bar to display the following menu:

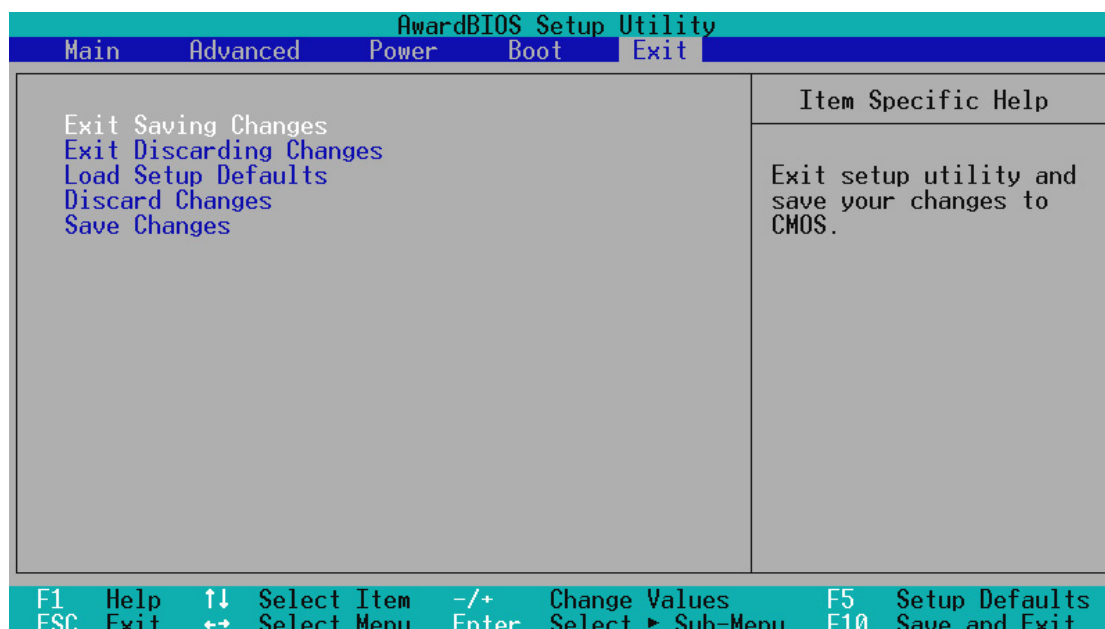

NOTE: Pressing <Esc> does not exit this menu. You must select one of the options from this menu or <F10> from the legend bar to exit this menu.

Exit Saving Changes

Once you are finished making your selections, choose this option from the Exit menu to ensure the values you selected are saved to the CMOS RAM. The CMOS RAM is sustained by an onboard backup battery and stays ON even when the PC is turned OFF. Once this option is selected, a confirmation is asked. Select [Yes] to save changes and exit.

NOTE: If you attempt to exit the Setup program without saving your changes, the program will prompt you with a message asking if you want to save your changes before exiting. Pressing <Enter> will then save changes while exiting.

Exit Discarding Changes

This option should only be used if you do not want to save the changes you have made to the Setup program. If you have made changes to fields other than system date, system time, and password, the system will ask for confirmation before exiting.

4. BIOS SETUP

Load Setup Defaults

This option allows you to load the default values for each of the parameters on the Setup menus. When this option is selected or if <F5> is pressed, a confirmation is requested. Select [Yes] to load default values. You can now select **Exit Saving Changes** or make other changes before saving the values to the non-volatile RAM.

Discard Changes

This option allows you to discard the selections you made and restore the values you previously saved. After selecting this option, a confirmation is requested. Select [Yes] to discard any changes and load the previously saved values.

Save Changes

This option saves your selections without exiting the Setup program. You can then return to other menus and make changes. After selecting this option, all selections are saved and a confirmation is requested. Select [Yes] to save any changes to the non-volatile RAM.

4. BIOS SETUP

(This page was intentionally left blank.)

5. SOFTWARE SETUP

ASUS Smart Motherboard Support CD

NOTE: The support CD contents are subject to change at any time without notice.

To begin using your support CD disc, just insert it into your CD-ROM drive and the support CD installation menu should appear. If the menu does not appear, double click or run **D:\SETUP.EXE** (assuming that your CD-ROM drive is drive **D:**).

Support CD Main Menu

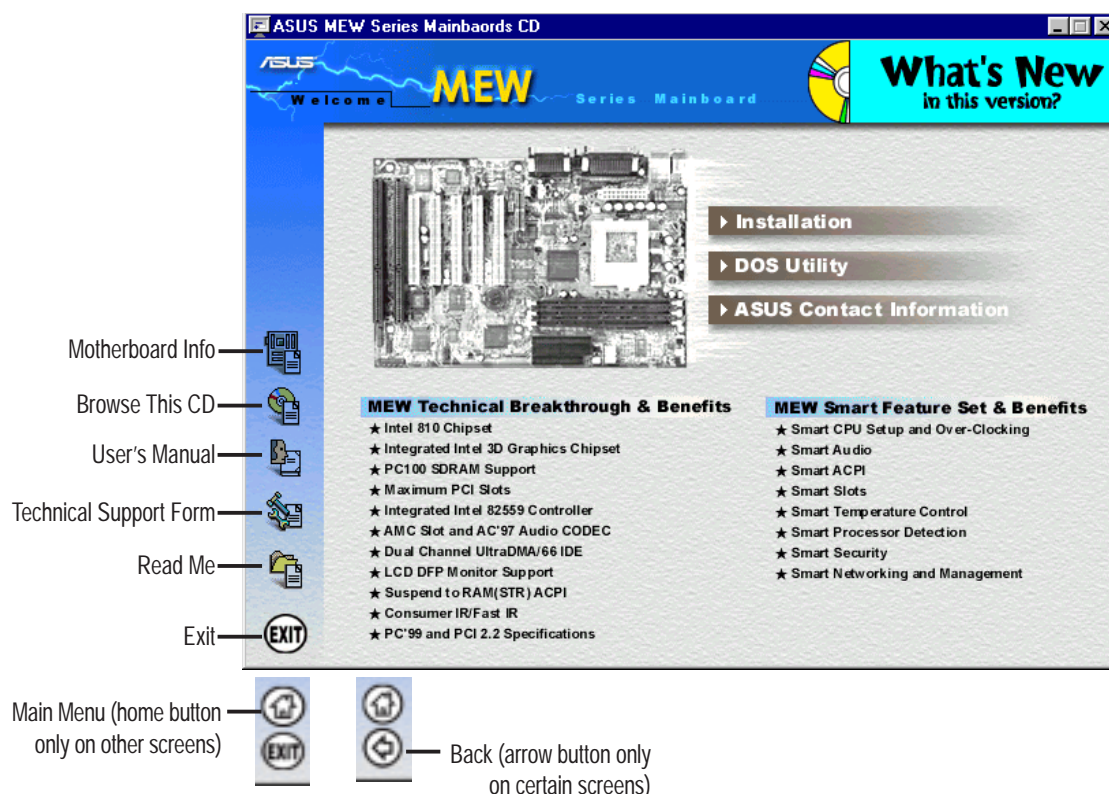

Navigation Button Descriptions

Motherboard Info displays information on your motherboard, BIOS, and CPU.

Browse This CD allows you to see the contents of the ASUS Support CD.

User's Manual displays the motherboard user's manual in pdf format.

Technical Support Form opens up a blank Technical Support Request Form for you to fill and print out when you run into technical difficulties and need technical assistance.

Read Me opens up a file containing additional notes.

Home returns you to the main menu of the support CD. (only on other screens)

Exit allows you to close the support CD.

Back returns you one screen back on the support CD.

5. SOFTWARE SETUP

Software Setup Contents

NOTE: The support CD contents are subject to change at any time without notice.

5. SOFTWARE SETUP	77
ASUS Smart Motherboard Support CD	77
Software Setup Contents	78
Support CD Content Descriptions	79
Installation	79
DOS Utility	80
ASUS Contact Information	80
Other Useful Information	80
Operating Systems	81
Windows 98	81
5.1 Intel LANDesk Client Manager (LDCM)	82
5.2 ASUS PC Probe	83
5.3 ASUS Update	84
5.4 Driver	85
5.4.1 Network Driver Setup (LAN model only)	85
5.4.2 VGA Driver Setup	86
5.4.3 Audio Driver Setup (audio model only)	87
5.5 Other	88
5.5.2 INF Update Utility for 810 Chipset	88
5.5.3 Intel Security Controller Driver	89
5.5.4 YAMAHA S-YXG50	90
5.5.5 Microsoft DirectX 6.0 Driver	91
5.5.6 PC-cillin 98 V4.06	92
5.5.7 Adobe Acrobat Reader V4.0	93
5.6 ASUS DMI Utility	94
5.7 Flash BIOS Utility (DOS)	95
5.8 Uninstalling Programs	96

5. SOFTWARE SETUP

Support CD Content Descriptions

NOTE: The support CD contents are subject to change at any time without notice.

Installation

5.1 LDCM (**NOTE: Current version does not support the MEW-L motherboard.**)

Intel's LanDesk Client Manager software can monitor the local computer system and/or other computer systems on the network within the same bridge address. (At the time this User's Manual was written, LDCM V3.32 and earlier does not support this motherboard. Please contact your vendor for a later version.) **NOTE: Will not run with ASUS PC Probe installed.**

5.2 ASUS PC Probe (**NOTE: Will not run with LDCM installed.**)

Installs a simple software to monitor your computer's fan, temperature, and voltages.

5.3 ASUS Update

Installs a program to help you update your BIOS or download a BIOS image file.

5.4 Driver

Installs the necessary drivers for your onboard components to work properly.

5.4.1 Network Driver Setup – Installs “Intel 8255x-based PCI Ethernet Adapter (10/100)”

5.4.2 SCSI Driver Setup – (not available on this motherboard)

5.4.3 VGA Driver Setup – Installs “810 DC-100 System and Graphics Controller Driver”

5.4.4 Audio Driver Setup – Installs “Intel(R) 82801AA/AB AC'97 Audio Controller:SigmaTel Codec”

5.5 Other

Allows you to install additional software and utilities to help you make better use of your new motherboard.

5.5.1 Read Motherboard User's Manual (PDF) – This allows you to read the MEW-L User's Manual in Adobe Acrobat Portable Document Format. (The User's Manual is only preliminary at the time this support CD was created. For updated User's Manual, please visit the ASUS web site.)

5.5.2 INF Update Utility for 810 Chipset – This utility installs INF files in Windows for the following items: System and Graphics, LPC Interface, SM Bus, PCI Bridge, Bus Master IDE, USB Host, Controllers

5. SOFTWARE SETUP

- 5.5.3 Intel Security Controller Driver** – Installs a security controller for your Windows 95/98. Read the Release Notes during installation and the Readme file at the end of the installation for more information.
- 5.5.4 YAMAHA S-YXG50** – Installs Yamaha’s software synthesizer for enhancing audio output and XG Player for advanced playing of MIDI files. (YAMAHA, Soft Synthesizer, S-YXG50, Midplug, and XG studio are all trademarks of Yamaha Corp. Copyright 1996-1999 Yamaha Corporation, All Rights Reserved)
- 5.5.5 Microsoft DirectX 6.0 Driver** – Installs Microsoft’s DirectX 6.0 driver for Windows 95/98. Microsoft’s DirectX is necessary for most multimedia applications to run.
- 5.5.6 PC-cillin 98 V4.06** – Installs Trend’s PC-cillin virus protection software. View the online help for more information.
- 5.5.7 Adobe Acrobat Reader V4.0** – Installs the Adobe Acrobat Reader software necessary to view user’s manuals saved in PDF format. Updated or other language versions of this motherboard’s manual is available in PDF format at any of our web sites.

DOS Utility

5.6 ASUS DMI Configuration Utility

Gives information on using the DMI configuration utility. This utility is located in the DMI folder under the root directory of the support CD.

5.7 Flash BIOS Utility (DOS Version)

Provides information on the Flash BIOS utility (AFLASH.EXE). Choose “Restart in MS-DOS mode” then type “aflash” from the AFLASH folder on the support CD.

ASUS Contact Information

This page gives Marketing and Technical Support contact information which is similar to the one in the beginning of this User’s Manual.

Other Useful Information

5.8 Uninstalling Programs

Information on uninstalling programs in Windows 98.

5. SOFTWARE SETUP

Operating Systems

Although ASUS motherboards passed testing on several operating systems, the operating system shown in these sections will be that of Microsoft's Windows 98. You should always use the latest operating system and updates when using new hardware to ensure full compliancy. For Windows 95, you must use OSR 2.0 or later. For Windows NT 4.0, you must use Service Pack 3.0 or later.

Windows 98

When Windows 98 is installed for the first time. Subsequent restarts will result in the plug and play initializing the "Add New Hardware Wizard" and may attempt to install a driver from its system registry. When prompted to restart, select **No** and then follow the normal setup procedures later in this section.

IMPORTANT: Selecting **No** for the initial restart prompt is a necessary step because Windows may load an older display driver that is incompatible with the onboard VGA chip. Always use the driver available on the ASUS Support CD or an applicable driver update from your ASUS vendor or from the ASUS web site.

NOTE: Because there are various motherboard settings, options, and expansion cards, the following can only be used as a general reference and not an exact reflection of your system.

5. SOFTWARE SETUP

5.1 Intel LANDesk Client Manager (LDCM)

(At the time this User's Manual was written, LDCM V3.32 and earlier does not support this motherboard. Please contact your vendor for a later version.)

5. SOFTWARE SETUP

5.2 ASUS PC Probe

Insert the Support CD that came with your motherboard into your CD-ROM drive or double-click the CD drive icon in **My Computer** to bring up the setup screen.

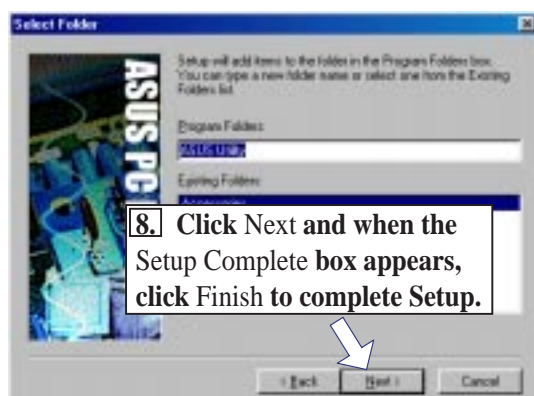

5. SAW SETUP
ASUS PC Probe

5. SOFTWARE SETUP

5.3 ASUS Update

Insert the Support CD that came with your motherboard into your CD-ROM drive or double-click the CD drive icon in **My Computer** to bring up the setup screen.



5. SOFTWARE SETUP

5.4 Driver

5.4.1 Network Driver Setup (LAN model only)

Insert the Support CD that came with your motherboard into your CD-ROM drive or double-click the CD drive icon in **My Computer** to bring up the setup screen.



NOTE: You may be asked for the Ethernet driver path. If so, enter “d:\lan” (“d” being your CD-ROM drive)

5. SOFTWARE SETUP

5.4.2 VGA Driver Setup

Insert the Support CD that came with your motherboard into your CD-ROM drive or double-click the CD drive icon in **My Computer** to bring up the setup screen.

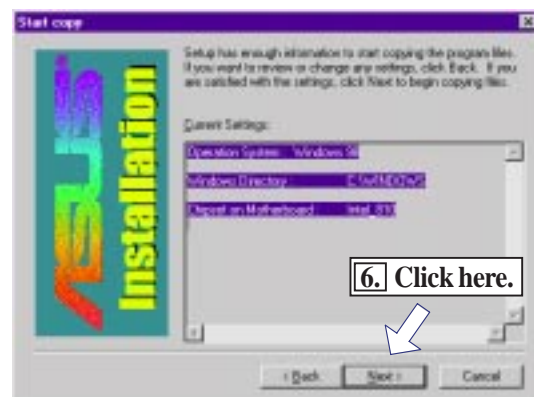

NOTE: If you are asked for the driver, enter the path “d:\vga\win98” (“d” being your CD-ROM path and “win98” being your operating system)



5. SOFTWARE SETUP

5.4.3 Audio Driver Setup (audio model only)

Insert the Support CD that came with your motherboard into your CD-ROM drive or double-click the CD drive icon in **My Computer** to bring up the setup screen.

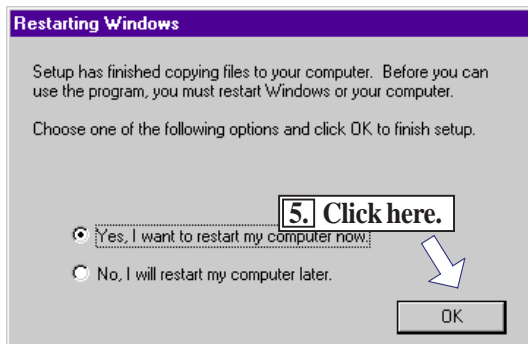
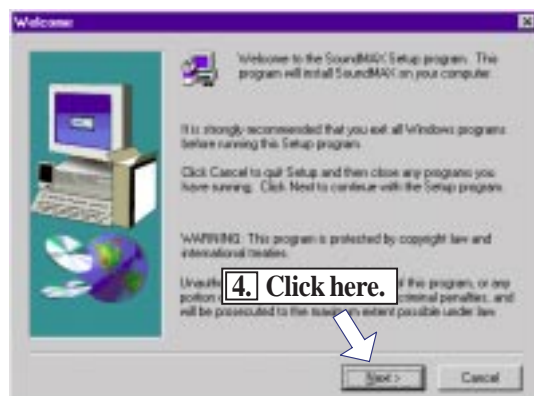

5. SOFTWARE SETUP

5.5 Other

5.5.2 INF Update Utility for 810 Chipset

Insert the Support CD that came with your motherboard into your CD-ROM drive or double-click the CD drive icon in **My Computer** to bring up the setup screen.

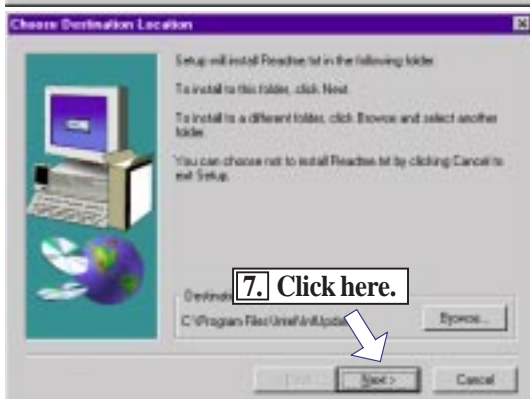
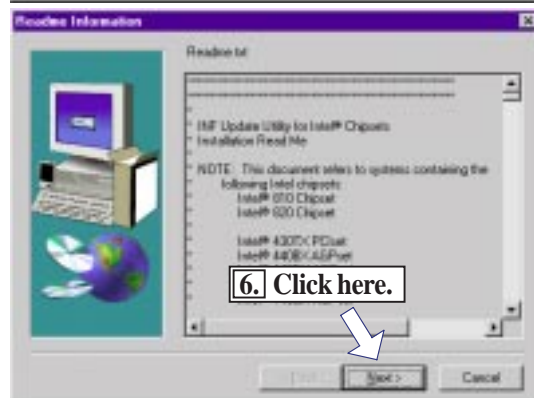
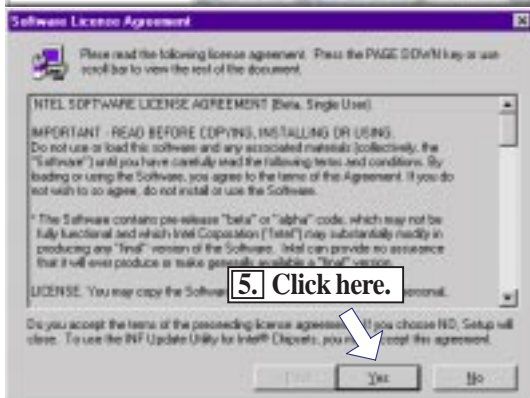

5. SW SETUP
INF Update Utility

5. SOFTWARE SETUP

5.5.3 Intel Security Controller Driver

Insert the Support CD that came with your motherboard into your CD-ROM drive or double-click the CD drive icon in **My Computer** to bring up the setup screen. (step 1, not shown here, is the setup menu)

The screenshots show the following steps:

- 2. Click here.** Points to the 'Driver' folder in the 'Installation' window.
- 3. Click here.** Points to the 'Intel Security Drivers' folder in the 'Installation Items' window.
- 4. Click here.** Points to the 'Next >' button in the 'Welcome' window.
- 5. Click here.** Points to the 'Next >' button in the 'Release Notes' window.
- 6. Click here.** Points to the 'Yes' button in the 'Software License Agreement' window.
- 7. Click here.** Points to the 'Next >' button in the 'Choose Destination Location' window.
- 8. Click here.** Points to the 'Next >' button in the 'Select Program Folder' window.
- 9. Click here to restart.** Points to the 'Restart' button in the 'Setup Complete' window.

5. SAW SETUP
Intel Security

5. SOFTWARE SETUP

5.5.4 YAMAHA S-YXG50

Insert the Support CD that came with your motherboard into your CD-ROM drive or double-click the CD drive icon in **My Computer** to bring up the setup screen. (step 1, not shown here, is the setup menu)

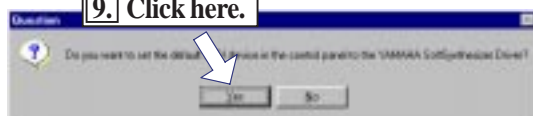
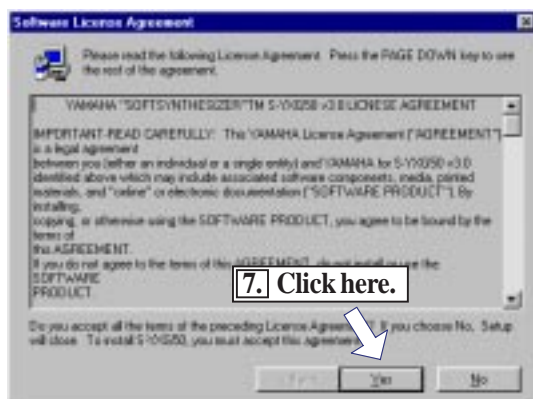
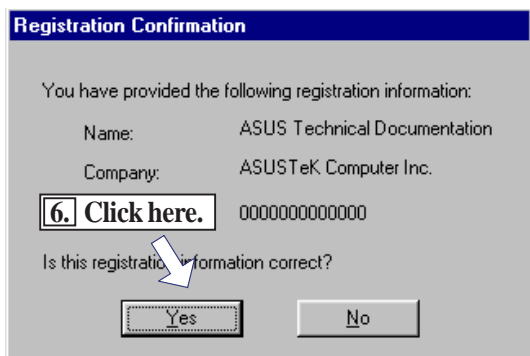
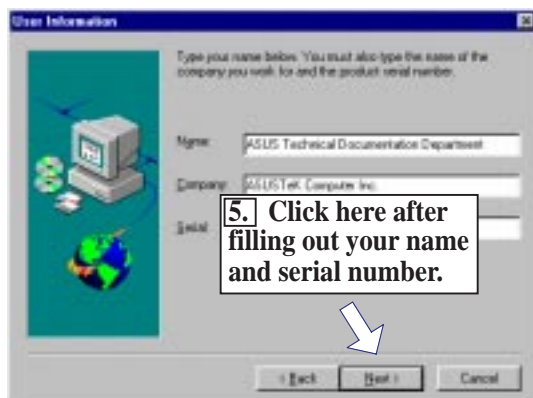

5. SOFTWARE SETUP

5.5.5 Microsoft DirectX 6.0 Driver

Insert the Support CD that came with your motherboard into your CD-ROM drive or double-click the CD drive icon in **My Computer** to bring up the setup screen.

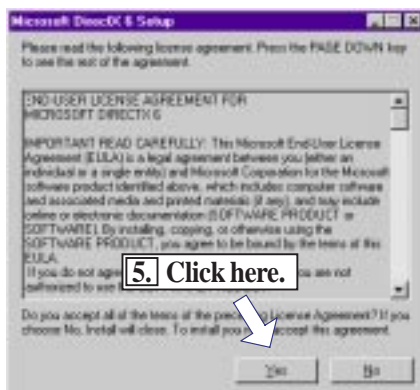
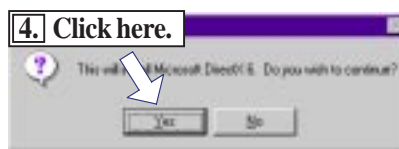

5. SAW SETUP
DirectX 6.0

5. SOFTWARE SETUP

5.5.6 PC-cillin 98 V4.06

Insert the Support CD that came with your motherboard into your CD-ROM drive or double-click the CD drive icon in **My Computer** to bring up the setup screen. (steps 1 and 2, not shown here, are the setup and installation menus)

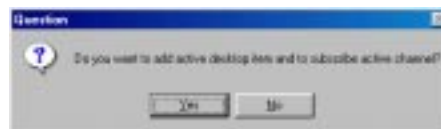

8 & 9. Select the preferred features by clicking the appropriate buttons.

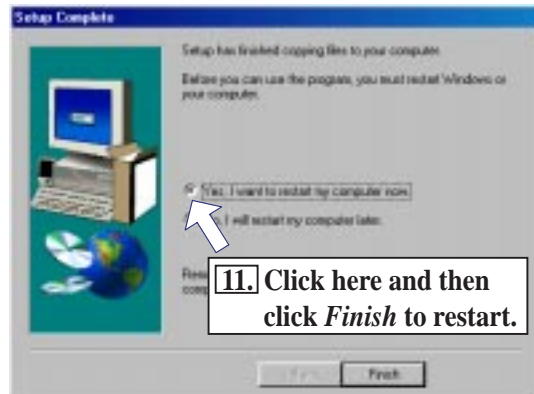
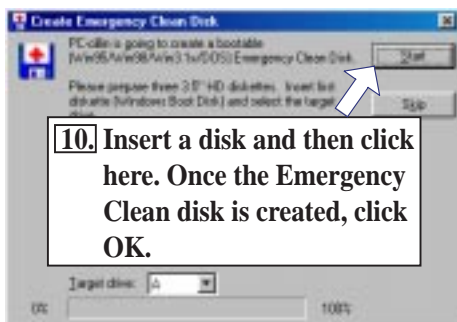
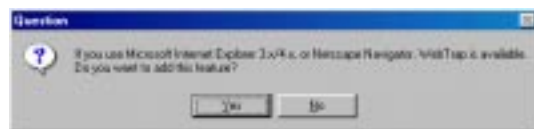

5. SOFTWARE SETUP

5.5.7 Adobe Acrobat Reader V4.0

Insert the Support CD that came with your motherboard into your CD-ROM drive or double-click the CD drive icon in **My Computer** to bring up the setup screen.

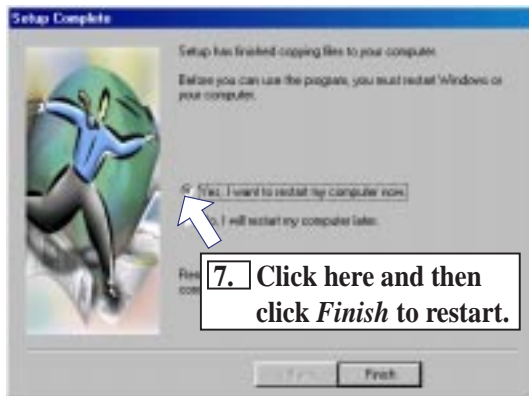
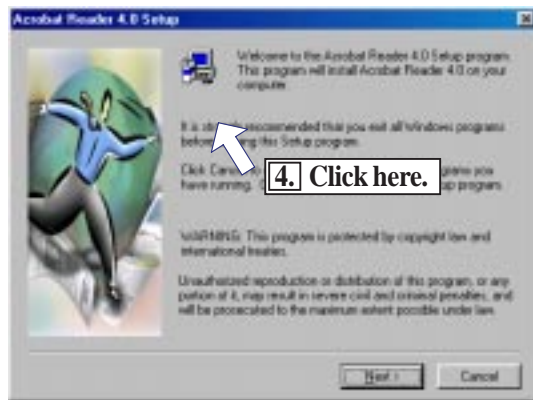

5. SAW SETUP
Acrobat Reader

5. SOFTWARE SETUP

5.6 ASUS DMI Utility

Insert the Support CD that came with your motherboard into your CD-ROM drive or double-click the CD drive icon in **My Computer** to bring up the setup screen.

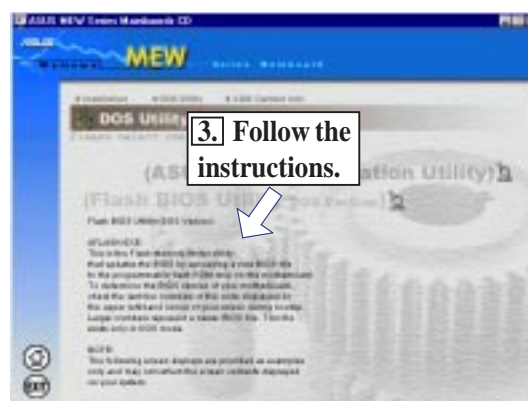

5. SOFTWARE SETUP

5.7 Flash BIOS Utility (DOS)

Insert the Support CD that came with your motherboard into your CD-ROM drive or double-click the CD drive icon in **My Computer** to bring up the setup screen.



5. SOFTWARE SETUP

5.8 Uninstalling Programs

Add/Remove Programs is a basic component within Windows. You may use this function if a program does not provide its own uninstallation program.

1. Double-click here to open the *Add/Remove Programs Properties* dialog box.

2. Select the program you wish to remove and click here.

3. Click here.

Remove Programs From Your Computer

unInstallShield will remove the s Manager' from your computer. If the following components is retr

- ✓ Shared program files...
- ✓ Standard program files
- ✓ Folder items...
- ✓ Program folders...
- ✓ Program directories...
- ✓ Program registry entries...

Uninstall completed. [3. Click here.] be removed. You should manually remove items related to the application.

OK

6. SOFTWARE REFERENCE



6. SOFTWARE REFERENCE

Software Reference Contents

6. SOFTWARE REFERENCE	97
6.1 ASUS PC Probe	99
Starting ASUS PC Probe	99
Using ASUS PC Probe	100
Monitoring	100
Information	101
Utility	102
ASUS PC Probe Task Bar Icon	103
6.2 ASUS Update	105
6.3 Display Properties	107
General	107
Adapter	107
Monitor	108
Performance	108
Color Management	108
Information	109
Color (Desktop)	109
Color (Direct3D/Game)	109
Display	110
Display (2)	110
6.4 YAMAHA S-YXG50	111
Starting	111
S-YXG50 Setup	111
XGplayer	111
6.5 Desktop Management Interface (DMI)	113
Introducing the ASUS DMI Configuration Utility	113
Starting the ASUS DMI Configuration Utility	113
Using the ASUS DMI Configuration Utility	114
Notes	114
6.6 Hardware Information	116

For instructions and references on other software and utilities, please use the programs' online help and electronic documentations.

6. SOFTWARE REFERENCE

6.1 ASUS PC Probe

ASUS PC Probe is a convenient utility to continuously monitor your computer system's vital components, such as fan rotations, voltages, and temperatures. It also has a utility that lets you review useful information about your computer, such as hard disk space, memory usage, and CPU type, CPU speed, and internal/external frequencies through the DMI Explorer.

Starting ASUS PC Probe

When ASUS PC Probe starts, a splash screen appears allowing you to select whether to show the screen again when you open PC Probe or not. To bypass this startup screen, clear the **Show up in next execution** check box.

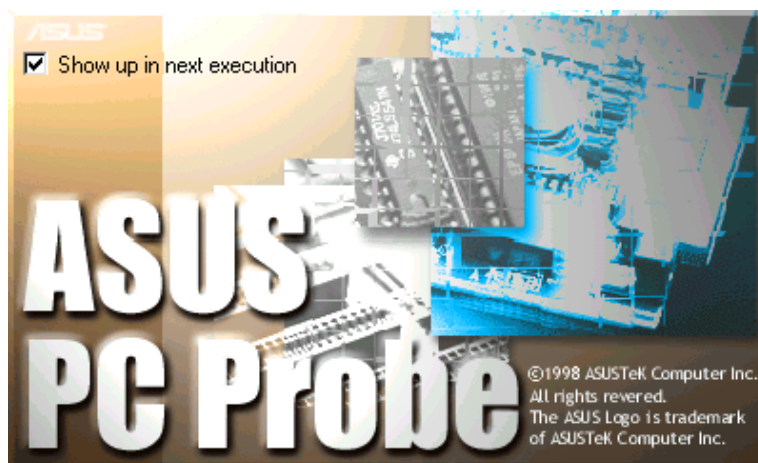

To open **ASUS PC Probe**, click the Windows **Start** button, point to **Programs**, and then **ASUS Utility**, and then click **Probe Vx.xx**.

The PC Probe icon  will appear on the taskbar's system tray indicating that ASUS PC Probe is running. Clicking the icon will allow you to see the status of your PC.



6. SOFTWARE REFERENCE

Using ASUS PC Probe Monitoring

Monitor Summary

Shows a summary of the items being monitored.



Temperature Monitor

Shows the PC's temperature.

Temperature Warning threshold adjustment
(Move the slider up to increase the threshold level or down to decrease the threshold level)



Fan Monitor

Shows the PC's fan rotation.

Fan Warning threshold adjustment
(Move the slider up to increase the threshold level or down to decrease the threshold level)



Voltage Monitor

Shows the PC's voltages.

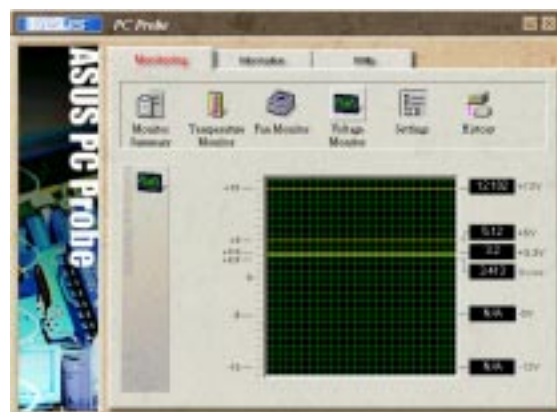

6. SOFTWARE REFERENCE

Settings

Lets you set threshold levels and polling intervals or refresh times of the PC's temperature, fan rotation, and voltages.



History

Lets you record the monitoring activity of a certain component of your PC by date, time, and target history.

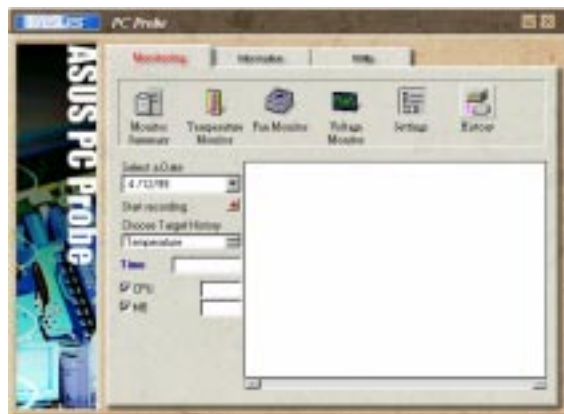

Information

Hard Drives

Shows the used and free space of the PC's hard disk drives and the file allocation table or file system used.



Memory

Shows the PC's memory load, memory usage, and paging file usage.



6. SOFTWARE REFERENCE

Device Summary

Shows a summary of devices in your PC.



DMI Explorer

Shows information pertinent to the PC, such as CPU type, CPU speed, and internal/external frequencies, and memory size.



Utility

Lets you run programs outside of the ASUS Probe modules. To run a program, click **Execute Program**.



6. SOFTWARE REFERENCE

ASUS PC Probe Task Bar Icon

Right clicking the PC Probe icon will bring up a menu to open or exit ASUS PC Probe and pause or resume all system monitoring.



When the ASUS PC Probe senses a problem with your PC, portions of the ASUS PC Probe icon changes to red, the PC speaker beeps, and the ASUS PC Probe monitor is displayed.

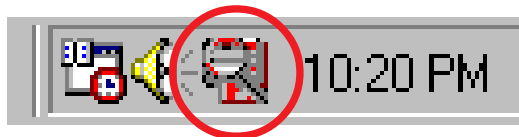

6. SOFTWARE REFERENCE

(This page was intentionally left blank)

6. SOFTWARE REFERENCE

6.2 ASUS Update

ASUS Update is a utility that allows you to update your motherboard's BIOS and other drivers. The use of this utility with the Internet requires that you are properly connected to the internet through an Internet Service Provider.

Start ASUS Update

Launch the utility from **Start | Programs | ASUS Utility | ASUS Update V2.00**

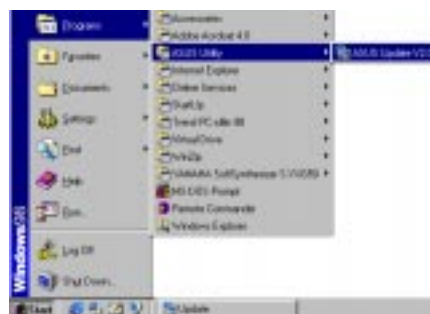

Select the update method:

Update BIOS from local disk allows you to specify a BIOS image file on your local disk.

Update BIOS/Driver from Internet will automatically download an updated BIOS image file from the Internet if available and start the update process.

Download BIOS/Driver from Internet allows you to download a BIOS image file for you to update later.



Select an internet site

Choose the site that is closest to you or choose **Auto Select**.



Updating from local disk

If you chose Update BIOS from local disk, you will be prompted to locate the file.



6. SOFTWARE REFERENCE

You will be prompted that running applications will be closed in order to continue with the BIOS update process.



6. SOFTWARE REFERENCE

6.3 Display Properties

The motherboard's built-in 2D/3D AGP VGA supports professional graphics design, gaming, learning, and business applications.

NOTE: Depending on your system configuration, components, and options, your system may not show all of the settings displayed in the following pictures.

To open the Properties dialog box, right-click the desktop and select **Properties**, then select the **Settings** tab, and the **Advanced** button.

General

The **Display** box displays the current font size of the selected monitor. To use a different font size, click the arrow, and then click the font size you want.

The **Compatibility** box lets you specify that you want your computer to apply changes to system color settings without restarting. **NOTE:** Some programs might not display colors correctly without being restarted after you make changes. To avoid this problem, close the program, change the color settings, and then open the program again.



Adapter

Shows what type of display adapter you are currently using. To install the software for a new display adapter, click **Change**.



6. SOFTWARE REFERENCE

Monitor

Shows what type of monitor you are currently using. To install the software for a new monitor, click **Change**.

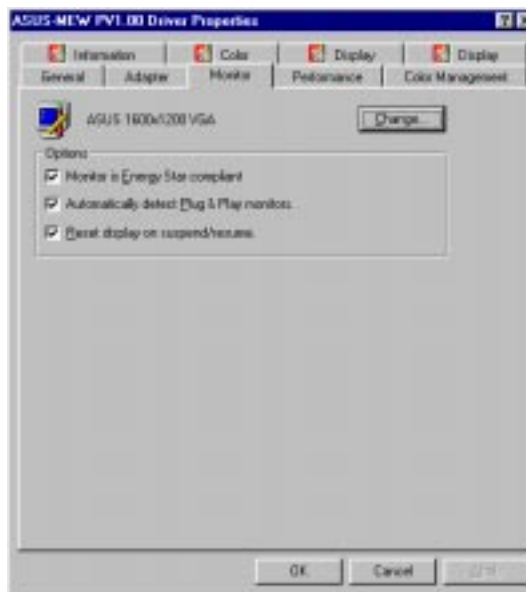

Performance

Specifies the degree of acceleration you want for your graphics hardware. Full acceleration is the fastest and is recommended for most computers. If your computer is having problems and you suspect graphics acceleration to be the cause, use the highest setting at which you do not have problems.



Color Management

Lists all the color profile currently associated with your monitor. Click a profile to make it the active profile. Otherwise, the default profile is the active profile.



6. SOFTWARE REFERENCE

Information

Gives you information on your graphics device such as chipset, memory, BIOS, and drivers. Internet links are also available for easy access to the ASUS Web page for new updated drivers and notices.



Color (Desktop)

Allows you to adjust the quality of your display according to your preference. Gamma correction is available only in 16-bit color and 24-bit color (true color, 16.7M-color) modes. In 16-color and 256-color modes, gamma correction function is not supported.



Color (Direct3D/Game)

This is the same as the color adjustments for the desktop but this applies to direct3D applications and games.



6. SOFTWARE REFERENCE

Display

Allows you to adjust the display position, size, and refresh rate.



Change current refresh rate

Allows you to adjust the currently displayed resolution refresh rate.

Change refresh rate

Allows you to adjust the default refresh rates for each resolution and color settings.

Display (2)

Allows you to select the output device—PC Monitor or Digital Flat Panel (DFP)

NOTE: DFP only works in 1024x768 or less resolutions.



6. SOFTWARE REFERENCE

6.4 YAMAHA S-YXG50

Bundled with this support CD is Yamaha's Software Synthesizer and MIDI player.

Starting

You can start the Software Synthesizer by launching **S-YXG50 Setup** through **Start|Programs**. Yamaha's MIDI player can be launched using **XGplayer** through **Start|Programs**.

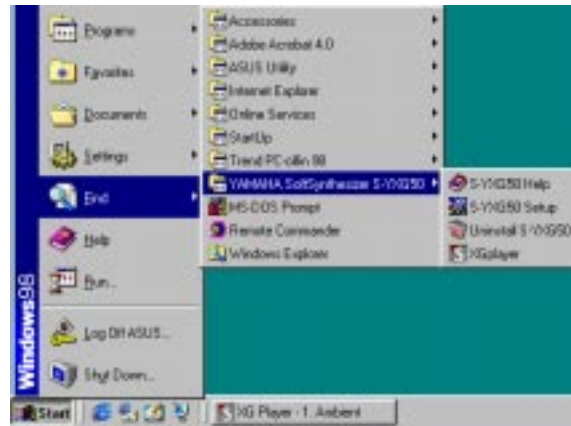

S-YXG50 Setup

Yamaha's S-YXG50 software synthesizer as shown here has many detailed settings. You may read the **S-YXG50 Help** for information on using this utility.

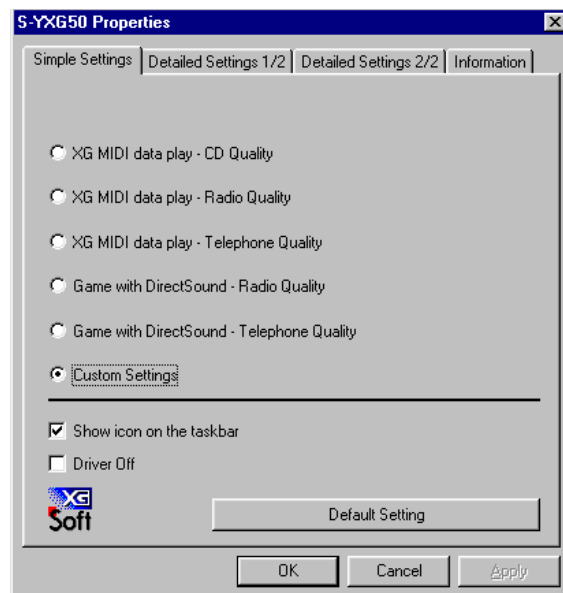

XGplayer

Yamaha's XGplayer allows you to play the great list of included MIDI files or any other *.mid or *.rmi files using the powerful full-featured controls. You may read the **S-YXG50 Help** for information on using this utility.



6. SOFTWARE REFERENCE

(This page was intentionally left blank)

6. SOFTWARE REFERENCE

6.5 Desktop Management Interface (DMI)

Introducing the ASUS DMI Configuration Utility

This motherboard supports DMI within the BIOS level and provides a DMI Configuration Utility to maintain the Management Information Format Database (MIFD). DMI is able to auto-detect and record information pertinent to a computer's system such as the CPU type, CPU speed, and internal/external frequencies, and memory size. The onboard BIOS will detect as many system information as possible and store those collected information in a 4KB block in the motherboard's Flash EPROM and allow the DMI to retrieve data from this database. Unlike other BIOS software, the BIOS on this motherboard uses the same technology implemented for Plug and Play to allow dynamic real-time updating of DMI information versus creating a new BIOS image file and requiring the user to update the whole BIOS. This DMI Configuration Utility also allows the system integrator or end user to add additional information into the MIFD such as serial numbers, housing configurations, and vendor information. Those information not detected by the motherboard BIOS and has to be manually entered through the DMI Configuration Utility and updated into the MIFD. This DMI Configuration Utility provides the same reliability as PnP updating and will prevent the refreshing failures associated with updating the entire BIOS.

Starting the ASUS DMI Configuration Utility

The DMI Configuration Utility (DMICFG2.EXE) must be used in real mode in order for the program to run, the base memory must be at least 180K. Memory managers like HIMEM.SYS (required by windows) must not be installed. You can boot up from a system diskette without AUTOEXEC.BAT and CONFIG.SYS files, "REM" HIMEM.SYS in the CONFIG.SYS, or press <Shift>+<F5> during bootup to bypass your AUTOEXEC.BAT and CONFIG.SYS files.

1. In Windows, copy DMICFG2.EXE to your hard disk drive.
2. Restart your computer and press <Shift>+<F5> during bootup to enter safe mode command prompt.
3. Go to the directory containing DMICFG2.EXE.
4. Type DMICFG2 and press <Enter> to run.

6. SOFTWARE REFERENCE

Using the ASUS DMI Configuration Utility

NOTE: The following screen displays are provided as examples only and may not reflect the screen contents on your system.

Edit DMI (or delete)

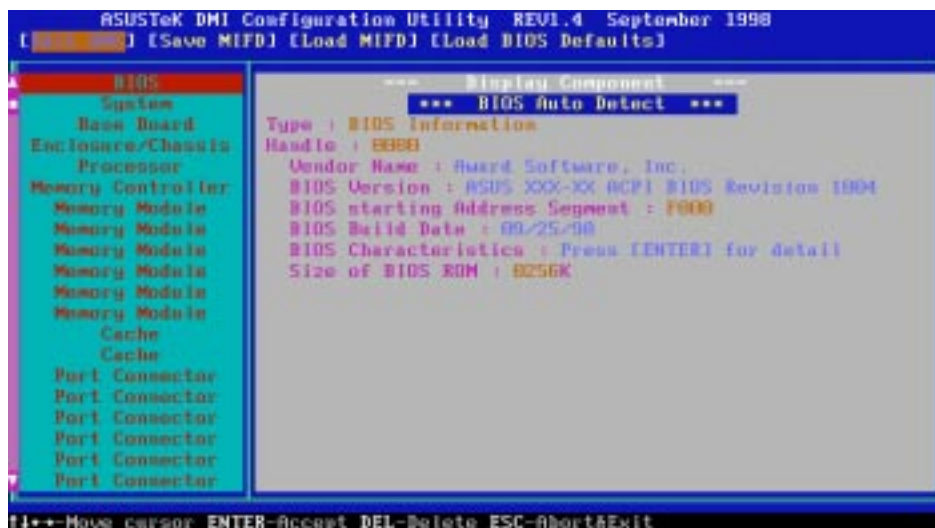

Use the ←→ (left-right) cursors to move the top menu items and the ↑↓ (up-down) cursor to move between the left hand menu items. The bottom of the screen will show the available keys for each screen. Press enter at the menu item to enter the right hand screen for editing. “Edit component” appears on top. The reversed color field is the current cursor position and the blue text are available for editing. The orange text shows auto-detected information and are not available for editing. The blue text “Press [ENTER] for detail” contains a second pop-up menu is available, use the + - (plus-minus) keys to change the settings. Enter to exit *and save*, ESC to exit *and not save*.

If the user has made changes, ESC will prompt you to answer Y or N. Enter Y to go back to the left-hand screen *and save*, enter N to go back to left-hand screen and *not save*. If editing has not been made, ESC will send you back to the left hand menu without any messages.

Notes

A heading, *** BIOS Auto Detect ***, appears on the right for each menu item on the left side that has been auto detected by the system BIOS.

A heading, *** User Modified ***, will appear on the right for menu items that have been modified by the user.



6. SOFTWARE REFERENCE

Save MIFD



You can save the MIFD (normally only saved to flash ROM) to a file by entering the drive and path here. If you want to cancel save, you may press ESC and a message “Bad File Name” appears here to show it was not saved.

Load MIFD



You can load the disk file to memory by entering a drive and path and file name here.

Load BIOS Defaults



You can load the BIOS defaults from a MIFD file and can clear all user modified and added data. You must reboot your computer in order for the defaults to be saved back into the Flash BIOS.

6. SOFTWARE REFERENCE

6.6 Hardware Information

If you click on the motherboard image, you will be given three selections. These three selections will give you hardware information about your motherboard. Click on either **Feature**, **Component**, or **Jumper Settings** to learn more about your motherboard.

NOTE: Hardware information may vary from source to source due to the difference in time each source is produced. Here is the order from earliest (oldest) to latest (newest) for which hardware information is updated: Support CD Screens, Support CD PDF, Printed User's Manual, ASUS Web Site PDF.



7. APPENDIX

7.1 Glossary

AGP (Accelerated Graphics Port)

An interface specification that enables high-performance 3D graphics on mainstream PCs. AGP offers a higher throughput than PCI by providing the graphics controller with direct access to system memory.

Bus	Bus Frequency	Bus Speed
PCI	33MHz	133MB/s
AGP 1X	66MHz	200-300MB/s
AGP 2X	133MHz	528MB/s
AGP 4X	266MHz	1 GB/s

AUTOEXEC.BAT

AUTOEXEC.BAT is a special-purpose file that is automatically executed by DOS whenever the computer is turned ON or restarted. This file contains important commands that help configure the system to work with certain software and devices. Windows 95 and later has its own startup files and may not use or may ignore parts of the AUTOEXEC.BAT file.

BIOS (Basic Input/Output System)

BIOS is a set of routines that affect how the computer transfers data between computer components, such as memory, disks, and the display adapter. The BIOS instructions are built into the computer's read-only memory. BIOS parameters can be configured by the user through the BIOS Setup program. The BIOS can be updated using the provided utility to copy a new BIOS file into the EEPROM.

Bit (Binary Digit)

Represents the smallest unit of data used by the computer. A bit can have one of two values: 0 or 1.

Boot

Boot means to start the computer operating system by loading it into system memory. When the manual instructs you to "boot" your system (or computer), it means to turn ON your computer. "Reboot" means to restart your computer. When using Windows 95 or later, selecting "Restart" from "Start | Shut Down..." will reboot your computer.

Bus Master IDE

PIO (Programmable I/O) IDE requires that the CPU be involved in IDE access and waiting for mechanical events. Bus master IDE transfers data to/from the memory without interrupting the CPU. Bus master IDE driver and bus master IDE hard disk drives are required to support bus master IDE mode.

7. APPENDIX

Byte (Binary Term)

One byte is a group of eight contiguous bits. A byte is used to represent a single alphanumeric character, punctuation mark, or other symbol.

COM Port

COM is a logical device name used by to designate the computer serial ports. Pointing devices, modems, and infrared modules can be connected to COM ports. Each COM port is configured to use a different IRQ and address assignment.

CPU (Central Processing Unit)

The CPU, sometimes called “Processor,” actually functions as the “brain” of the computer. It interprets and executes program commands and processes data stored in memory. Currently, there are socket 370 (for Pentium Celeron-PPGA), socket 7 (for Pentium, AMD, Cyrix, IBM), slot 1 (for Pentium II and III), and slot 2 (for Xeon) processors.

Device Driver

A device driver is a special set of instructions that allows the computer’s operating system to communicate with devices such as VGA, audio, ethernet, printer, or modem.

DOS (Disk Operating System)

DOS is the foundation on which all other programs and software applications operate, including Windows. DOS is responsible for allocating system resources such as memory, CPU time, disk space, and access to peripheral devices. For this reason, DOS constitutes the basic interface between you and your computer.

Hardware

Hardware is a general term referring to the physical components of a computer system, including peripherals such as printers, modems, and pointing devices.

IDE (Integrated Drive Electronics)

IDE devices integrate the drive control circuitry directly on the drive itself, eliminating the need for a separate adapter card (in the case for SCSI devices). UltraDMA/33 IDE devices can achieve up to 33MB/Sec transfer.

LPT Port (Line Printer Port)

Logical device name reserved by DOS for the computer parallel ports. Each LPT port is configured to use a different IRQ and address assignment.

MMX

A set of 57 new instructions based on a technique called Single Instruction, Multiple Data (SIMD), which is built into the new Intel Pentium PP/MT (P55C) and Pentium II (Klamath) CPU as well as other x86-compatible microprocessors. The MMX instructions are designed to accelerate multimedia and communications applications, such as 3D video, 3D sound, video conference.

7. APPENDIX

PCI Bus (Peripheral Component Interconnect Local Bus)

PCI bus is a specification that defines a 32-bit data bus interface. PCI is a standard widely used by expansion card manufacturers.

Peripherals

Peripherals are devices attached to the computer via I/O ports. Peripheral devices allow your computer to perform an almost limitless variety of specialized tasks.

POST (Power On Self Test)

When you turn on the computer, it will first run through the POST, a series of software-controlled diagnostic tests. The POST checks system memory, the motherboard circuitry, the display, the keyboard, the diskette drive, and other I/O devices.

PS/2 Port

PS/2 ports are based on IBM Micro Channel Architecture. This type of architecture transfers data through a 16-bit or 32-bit bus. A PS/2 mouse and/or keyboard may be used on ATX motherboards.

RAID (Redundant Array of Independent Disks)

RAID can be set up to provide mirroring (for fault tolerance), parity (for data guarding), or striping (for data distribution over several drives for increased performance). A RAID card is required to setup a RAID system.

RAM (Random Access Memory)

There are several different types of RAM such as DRAM (Dynamic RAM), EDO DRAM (Extended Data Output DRAM), SDRAM (Synchronous DRAM).

ROM (Read Only Memory)

ROM is nonvolatile memory used to store permanent programs (called firmware) used in certain computer components. Flash ROM (or EEPROM) can be reprogrammed with new programs (or BIOS).

SCSI (Small Computer System Interface)

High speed parallel interface defined by the X3T9.2 committee of the American National Standards Institute (ANSI) for connecting many peripheral devices.

System Disk

A system disk contains the core file of an operating system and is used to boot up the operating system.

UltraDMA/33

UltraDMA/33 is a new specification to improve IDE transfer rates. Unlike traditional PIO mode, which only uses the rising edge of IDE command signal to transfer data, UltraDMA/33 uses both rising edge and falling edge. Hence, the data transfer rate is double of the PIO mode 4 or DMA mode 2. (16.6MB/s x2 = 33MB/s).

7. APPENDIX

USB (Universal Serial Bus)

A new 4-pin serial peripheral bus that allows plug and play computer peripherals such as keyboard, mouse, joystick, scanner, printer and modem/ISDN to be automatically configured when they are attached physically without having to install drivers or reboot. With USB, the traditional complex cables from back panel of your PC can be eliminated.