

**ASUS<sup>®</sup> P4T-EM**

Intel<sup>®</sup> 850 ATX Motherboard

**USER'S MANUAL**

# USER'S NOTICE

---

No part of this manual, including the products and software described in it, may be reproduced, transmitted, transcribed, stored in a retrieval system, or translated into any language in any form or by any means, except documentation kept by the purchaser for backup purposes, without the express written permission of ASUSTeK COMPUTER INC. ("ASUS").

ASUS PROVIDES THIS MANUAL "AS IS" WITHOUT WARRANTY OF ANY KIND, EITHER EXPRESS OR IMPLIED, INCLUDING BUT NOT LIMITED TO THE IMPLIED WARRANTIES OR CONDITIONS OF MERCHANTABILITY OR FITNESS FOR A PARTICULAR PURPOSE. IN NO EVENT SHALL ASUS, ITS DIRECTORS, OFFICERS, EMPLOYEES OR AGENTS BE LIABLE FOR ANY INDIRECT, SPECIAL, INCIDENTAL, OR CONSEQUENTIAL DAMAGES (INCLUDING DAMAGES FOR LOSS OF PROFITS, LOSS OF BUSINESS, LOSS OF USE OR DATA, INTERRUPTION OF BUSINESS AND THE LIKE), EVEN IF ASUS HAS BEEN ADVISED OF THE POSSIBILITY OF SUCH DAMAGES ARISING FROM ANY DEFECT OR ERROR IN THIS MANUAL OR PRODUCT.

Product warranty or service will not be extended if: (1) the product is repaired, modified or altered, unless such repair, modification or alteration is authorized in writing by ASUS; or (2) the serial number of the product is defaced or missing.

Products and corporate names appearing in this manual may or may not be registered trademarks or copyrights of their respective companies, and are used only for identification or explanation and to the owners' benefit, without intent to infringe.

- Adobe and Acrobat are registered trademarks of Adobe Systems Incorporated.
- Intel, LANdesk, and Pentium are registered trademarks of Intel Corporation.
- Trend and ChipAwayVirus are trademarks of Trend Micro, Inc.
- Windows and MS-DOS are registered trademarks of Microsoft Corporation.

The product name and revision number are both printed on the product itself. Manual revisions are released for each product design represented by the digit before and after the period of the manual revision number. Manual updates are represented by the third digit in the manual revision number.

For previous or updated manuals, BIOS, drivers, or product release information, contact ASUS at <http://www.asus.com.tw> or through any of the means indicated on the following page.

SPECIFICATIONS AND INFORMATION CONTAINED IN THIS MANUAL ARE FURNISHED FOR INFORMATIONAL USE ONLY, AND ARE SUBJECT TO CHANGE AT ANY TIME WITHOUT NOTICE, AND SHOULD NOT BE CONSTRUED AS A COMMITMENT BY ASUS. ASUS ASSUMES NO RESPONSIBILITY OR LIABILITY FOR ANY ERRORS OR INACCURACIES THAT MAY APPEAR IN THIS MANUAL, INCLUDING THE PRODUCTS AND SOFTWARE DESCRIBED IN IT.

**Copyright © 2001 ASUSTeK COMPUTER INC. All Rights Reserved.**

Product Name: **ASUS P4T-EM**  
Manual Revision: **1.00 E903**  
Release Date: **November 2001**

# ASUS CONTACT INFORMATION

---

## ASUSTeK COMPUTER INC. (Asia-Pacific)

### *Marketing*

Address: 150 Li-Te Road, Peitou, Taipei, Taiwan 112  
Telephone: +886-2-2894-3447  
Fax: +886-2-2894-3449  
Email: info@asus.com.tw

### *Technical Support*

MB/Others (Tel): +886-2-2890-7121 (English)  
Notebook (Tel): +886-2-2890-7122 (English)  
Desktop/Server (Tel): +886-2-2890-7123 (English)  
Fax: +886-2-2980-7698  
Email: tsd@asus.com.tw  
WWW: www.asus.com.tw  
FTP: ftp.asus.com.tw/pub/ASUS  
Newsgroup: csnews.asus.com.tw

## ASUS COMPUTER INTERNATIONAL (America)

### *Marketing*

Address: 6737 Mowry Avenue, Mowry Business Center, Building 2  
Newark, CA 94560, USA  
Fax: +1-510-608-4555  
Email: tmd1@asus.com

### *Technical Support*

Fax: +1-510-608-4555  
Email: tsd@asus.com  
WWW: www.asus.com  
FTP: ftp.asus.com/Pub/ASUS

## ASUS COMPUTER GmbH (Europe)

### *Marketing*

Address: Harkortstr. 25, 40880 Ratingen, BRD, Germany  
Fax: +49-2102-442066  
Email: sales@asuscom.de (for marketing requests only)

### *Technical Support*

Hotline: MB/Others: +49-2102-9599-0 Notebook: +49-2102-9599-10  
Fax: +49-2102-9599-11  
Support (Email): www.asuscom.de/de/support (for online support)  
WWW: www.asuscom.de  
FTP: ftp.asuscom.de/pub/ASUSCOM

# CONTENTS

---

<b>1. INTRODUCTION .....</b>	<b>7</b>
1.1 How This Manual Is Organized .....	7
1.2 Item Checklist .....	7
<b>2. FEATURES .....</b>	<b>8</b>
2.1 The ASUS P4T-EM .....	8
2.1.1 Core Specifications .....	8
2.1.2 Connections .....	9
2.1.3 Optional Components .....	10
2.1.4 Performance and Intelligence .....	10
2.2 P4T-EM Motherboard Components .....	12
<b>3. HARDWARE SETUP .....</b>	<b>14</b>
3.1 P4T-EM Motherboard Layout .....	14
3.2 Layout Contents .....	15
3.3 Hardware Setup Procedure .....	16
3.4 Motherboard Settings .....	16
3.5 System Memory .....	21
3.6 Central Processing Unit (CPU) .....	23
3.7 Expansion Cards .....	27
3.8 External Connectors .....	30
3.9 Starting Up the First Time .....	41
<b>4. BIOS SETUP .....</b>	<b>43</b>
4.1 Managing and Updating Your BIOS .....	43
4.1.1 Upon First Use of the Computer System .....	43
4.1.2 Updating BIOS Procedures .....	44
4.2 BIOS Setup Program .....	47
4.2.1 BIOS Menu Bar .....	48
4.2.2 Legend Bar .....	48
4.3 Main Menu .....	50
4.3.1 Primary & Secondary Master/Slave .....	51
4.3.2 Keyboard Features .....	54
4.4 Advanced Menu .....	56
4.4.1 Chip Configuration .....	59
4.4.2 I/O Device Configuration .....	61
4.4.3 PCI Configuration .....	63
4.4.4 Shadow Configuration .....	65
4.5 Power Menu .....	66

# CONTENTS

---

4.5.1	Power Up Control .....	68
4.5.2	Hardware Monitor .....	69
4.6	Boot Menu .....	70
4.7	Exit Menu .....	72
5.1	Install Operating System .....	74
5.2	Start Windows .....	74
<b>5.</b>	<b>SOFTWARE SETUP .....</b>	<b>75</b>
5.3	P4T-EM Motherboard Support CD .....	75
<b>6.</b>	<b>SOFTWARE REFERENCE .....</b>	<b>77</b>
6.1	Winbond Smart Manager .....	77
6.2	ASUS PC Probe .....	81
6.3	ASUS Live Update .....	86
6.4	CyberLink PowerPlayer SE .....	87
6.5	CyberLink VideoLive Mail .....	88
<b>7.</b>	<b>APPENDIX .....</b>	<b>91</b>
7.1	Glossary .....	91
<b>INDEX</b>	<b>.....</b>	<b>95</b>

# FCC & DOC COMPLIANCE

---

This device complies with FCC Rules Part 15. Operation is subject to the following two conditions:

- This device may not cause harmful interference, and
- This device must accept any interference received, including interference that may cause undesired operation.

This equipment has been tested and found to comply with the limits for a Class B digital device, pursuant to Part 15 of the FCC Rules. These limits are designed to provide reasonable protection against harmful interference in a residential installation. This equipment generates, uses and can radiate radio frequency energy and, if not installed and used in accordance with manufacturer's instructions, may cause harmful interference to radio communications. However, there is no guarantee that interference will not occur in a particular installation. If this equipment does cause harmful interference to radio or television reception, which can be determined by turning the equipment off and on, the user is encouraged to try to correct the interference by one or more of the following measures:

- Re-orient or relocate the receiving antenna.
- Increase the separation between the equipment and receiver.
- Connect the equipment to an outlet on a circuit different from that to which the receiver is connected.
- Consult the dealer or an experienced radio/TV technician for help.

**WARNING!** Any changes or modifications to this product not expressly approved by the manufacturer could void any assurances of safety or performance and could result in violation of Part 15 of the FCC Rules.

Reprinted from the Code of Federal Regulations #47, part 15.193, 1993. Washington DC: Office of the Federal Register, National Archives and Records Administration, U.S. Government Printing Office.

## ***Canadian Department of Communications Statement***

This digital apparatus does not exceed the Class B limits for radio noise emissions from digital apparatus set out in the Radio Interference Regulations of the Canadian Department of Communications.

**This Class B digital apparatus complies with Canadian ICES-003.**

**Cet appareil numérique de la classe B est conforme à la norme NMB-003 du Canada.**

# 1. INTRODUCTION

## 1.1 How This Manual Is Organized

This manual is divided into the following sections:

<b>1. INTRODUCTION</b>	Manual information and checklist
<b>2. FEATURES</b>	Production information and specifications
<b>3. HARDWARE SETUP</b>	Instructions on setting up the motherboard.
<b>4. BIOS SETUP</b>	Instructions on setting up the BIOS
<b>5. SOFTWARE SETUP</b>	Instructions on setting up the included software
<b>6. SOFTWARE REFERENCE</b>	Reference material for the included software
<b>7. APPENDIX</b>	Optional items and general reference

## 1.2 Item Checklist

Check that your package is complete. If you discover damaged or missing items, contact your retailer.

### Package Contents

- (1) ASUS Motherboard
- (1) 40-pin 80-conductor ribbon cable for internal UltraDMA33/66/100 IDE drives
- (1) Ribbon cable for (1) 5.25" and (2) 3.5" floppy disk drives
- (1) ASUS 2-port USB connector set with bracket
- (1) Bag of spare jumpers
- (1) Support drivers and utilities
- (1) This Motherboard User's Manual
- (1) CPU Retention Module  
(Preinstalled on motherboard)
- (2) ASUS C-RIMM Continuity RIMM

### Optional Items

- ASUS IrDA-compliant infrared module
- Two Rambus Memory Modules
- LAN Card: PCI-L3C920
- 1394 Card: PCI-1394E

## 2. FEATURES

---

### 2.1 The ASUS P4T-EM

The ASUS P4T-EM motherboard is carefully designed for the demanding PC user who wants advanced features processed by the fastest processors.

#### 2.1.1 Core Specifications

- **Intel Processor Support:** Intel Socket 478 Pentium® 4 / Northwood™ processors, 1.4 to 2.0 GHz and higher.
- **Intel 850 Chipset:** Features the Intel® 850 chipset (82850 Memory Controller Hub, I/O Controller and Firmware Hub) with support for AGP 4X Mode, (1.5 volt only); 400MHz Front Side Bus (FSB); and dual channel RDRAM.
- **Intel ICH2:** The Intel I/O Controller Hub 2 (82801 ICH2) features support for UltraDMA/100, which allows burst mode data transfer rates of up to 100MB/sec; and two USB controllers for a total of 4 USB ports.
- **Low Pin Count (LPC) Super Multi-I/O:** Provides two high-speed UART compatible serial ports and one parallel port with EPP and ECP capabilities. UART2 can also be directed from COM2 to the Infrared Module for wireless connections.
- **PC800 Memory Support:** Equipped with four **Rambus Inline Memory Module (RIMM)** sockets to support Intel PC800/PC600-compliant Rambus DRAMs (RDRAMs) (available in 64, 96, 128, 192, 256, 512MB) up to 2GB. These RDRAMs are necessary to meet the increase in processor performance and multimedia and 3D functions, especially where high bandwidth is required.
- **Intel® Accelerated Hub Architecture:** Features a dedicated high speed hub link between the ICH2 and MCH with a bandwidth of 266MB/sec – twice the maximum bandwidth of the PCI bus.
- **UltraDMA/100 Support:** Comes with an onboard PCI Bus Master IDE controller with two connectors that support four IDE devices on two channels. Supports UltraDMA/100, UltraDMA/66, UltraDMA/33, PIO Modes 3 & 4 and Bus Master IDE DMA Mode 2, and Enhanced IDE devices, such as DVD-ROM, CD-ROM, CD-R/RW, LS-120, and Tape Backup drives.
- **Easy-to-Use DIP Switches:** As an alternative to JumperFree Mode™, jumpers and DSW switches are included to allow manual adjustment of the processor's external frequency.



## 2. FEATURES

---

### 2.1.2 Connections

- **CPU socket:** 478-pin surface mount, ZIF socket *mPGA478 B*.
- **PCI Expansion Slots:** Provides two 32-bit PCI slots, (PCI 2.2 compliant) with no ISA, eliminating bottlenecks and system memory management issues. All PCI slots can support Bus Master PCI cards, such as SCSI or LAN cards. (PCI supports up to 133MB/s maximum throughput.) The MB supports *Concurrent PCI*, which allows multiple PCI transfers from PCI master bus to the memory and processor.
- **AGP Slot:** Comes with an Accelerated Graphics Port slot that supports AGP cards for high performance, component level interconnect targeted at 3D graphical applications using a 4X mode bus. The slot is keyed to support only the latest 1.5 volt AGP cards: ASUS V3800 and newer versions.
- **CNR Support:** A Communication and Networking Riser (CNR) slot provides an interface to support very affordable multichannel audio, V.90 analog modem, Home PNA, 10/100 Ethernet networking, and a USB hub.
- **IDE connectors:** Dual-channel bus master IDE connectors support up to four Ultra DMA/100/66, PIO Modes 3 & 4 IDE devices. Both the primary (blue) and secondary (black) connectors are slotted to prevent incorrect insertion of the IDE ribbon cable.
- **Floppy disk connector:** Supports the floppy disk drive ribbon cable. One side of the connector is slotted to prevent incorrect insertion of the floppy disk cable.
- **Smartcard Reader Connector:** PS/SC compatible.
- **Intel Front Panel Connector:** Supports easy USB connectivity, control and monitoring of major PC functions.
- **USB ports:** Four Universal Serial Bus (USB) ports are available for connecting USB devices such as a mouse and PDA.
- **IrDA:** Supports an optional infrared port module for a wireless interface.
- **Serial ports:** Two 9-pin COM1/COM2 ports are for pointing devices or other serial devices.
- **Parallel port:** 25-pin port connects a parallel printer or other devices.
- **PS/2 mouse port:** Green 6-pin connector is for a PS/2 mouse.
- **PS/2 keyboard port:** Purple 6-pin connector is for a PS/2 keyboard.
- **Onboard LED:** Signals AC power is okay.
- **ATX power connector.** Supplies the MB with ATX power.
- **Microphone jack (optional):** Pink jack connects a microphone.
- **Line In jack (optional):** Light blue jack connects a tape player or other audio sources.
- **Line Out jack (optional):** Lime jack connects a headphone or a speaker.
- **Game/MIDI connector (optional):** This connector supports a joystick or a game pad for playing games, and MIDI devices.

## 2. FEATURES

---

### 2.1.3 Optional Components

- **AC'97 Codec:** The latest high-performance mini-chipset supports hi-fidelity 18-bit stereo, full duplex audio performance, up to four analog line inputs, two stereo outputs, and one mono output channel, 3D stereo enhancement.
- **SPDIFOUT Connector:** Enables digital audio output on multiple channels..
- **Onboard LAN:** Optional LAN NIC for full networking capability.

### 2.1.4 Performance and Intelligence

- **RDRAM Optimized Performance:** This motherboard supports Rambus Dynamic Random Access Memory (RDRAM). While PC100 SDRAM modules operate at 100MHz with a peak bandwidth of 0.8GB/s, MCH dual channel Rambus DRAMs can operate at up to 400MHz with a peak bandwidth of 3.2GB/s.
- **Enhanced ACPI & Anti-Boot Virus Protection:** Programmable BIOS (Flash EEPROM), offering enhanced Advanced Configuration and Power Interface (ACPI) for Windows XP/2000/Millennium compatibility, built-in firmware-based virus protection, and autodetection of most devices for virtually automatic setup. ACPI provides more Energy Saving Features for future operating systems (OS) supporting OS Direct Power Management (OSPM) functionality. With these features implemented in the OS, PCs can be ready around the clock, yet satisfy all the energy saving standards.
- **Smart BIOS:** 2Mbit firmware gives a new easy-to-use interface for more control and protection for the motherboard. Supports Vcore and CPU/RDRAM frequency adjustments, boot block write protection, and HD/SCSI/MO/ZIP/CD/Floppy boot selection.
- **Suspend and Go:** Suspend-to-RAM (STR) provides maximum power savings as an alternative to leaving the computer ON and QuickStart™ so that you do not have to wait for a long time for system bootup.
- **PC Health Monitoring:** An easy way to examine and manage system status information, such as CPU and system voltages, temperatures, and fan status through the onboard hardware and the bundled ASUS PC Probe or Intel LDCM software.
- **Desktop Management Interface (DMI):** Supports DMI through BIOS, which allows hardware to communicate within a standard protocol creating a higher level of compatibility. (Requires DMI-enabled components.)
- **Auto CPU Throttling Function:** Incorporated into this motherboard is a new technology to enable Pentium 4 processors auto throttling function. When auto throttling is enabled, the CPU will throttle down to 50% of its duty cycle when the CPU temperature reaches the threshold and return to 100% of its duty cycle when temperature lowers to normal level. This function ensures the best performance and reliability.

## 2. FEATURES

---

- **Smartcard Reader Connector:** This connector provides the convenience of PS/SC compatible Smart Card security plus support for a multitude of new financial, telephonic, and mobile access services.
- **Intel Front Panel Connector:** Supports an optional front panel for easy USB connectivity, control and monitoring of major PC functions.
- **Fan Status Monitoring and Alarm:** To prevent system overheat and system damage, the CPU and MAIN fans are monitored for speed and failure. All the fans are set for its normal RPM range and alarm thresholds.
- **Temperature Monitoring and Alert:** To prevent system overheat and system damage, this motherboard supports processor thermal sensing and auto-protection.
- **Voltage Monitoring and Alert:** System voltage levels are monitored to ensure stable current to critical motherboard components. Voltage specifications are more critical for future processors, so monitoring is necessary to ensure proper system configuration and management.
- **System Resources Alert:** Today's operating systems, such as Windows 98, Millenium, NT, 2000 and XP, require much more memory and hard drive space to present enormous user interfaces and run large applications. The onboard hardware ASUS ASIC in conjunction with either the bundled ASUS PC Probe or Intel LDCM will warn the user before the system resources are used up to prevent possible application crashes. Suggestions will give the user information on managing their limited resources more efficiently.
- **Dual Function Power Button:** Through BIOS, the power button can be defined as the "Stand by" (ie.: Suspend or Sleep) button or as the Soft-Off (see **ATX Power / Soft-Off Switch Lead** in **3.8 Connectors** for more information) button. Regardless of the setting, pushing the power button for more than 4 seconds will enter the Soft-Off mode.
- **Peripheral Power Up:** Keyboard or Mouse power up can be enabled or disabled through BIOS setup to allow the computer to be powered ON using your keyboard or mouse click.
- **New Compliancy:** Both the BIOS and hardware levels of the motherboard meet the stringent requirements for PC 99 certification. The new PC 99 requirements for systems and components are based on the following high-level goals: support for Plug and Play compatibility and power management for configuring and managing all system components, and 32-bit device drivers and installation procedures for Windows 95/NT and later. Color-coded connectors and descriptive icons make identification easy as required by PC 99.

## 2. FEATURES

### 2.2 P4T-EM Motherboard Components

See opposite page for locations.

	<b>Location</b>
<b>Processor Support</b>	Socket 478 for Pentium 4 Processors ..... 3
<b>Chipsets</b>	Intel 850 Memory Controller Hub (MCH) ..... 5
	Intel I/O Controller Hub 2 (ICH2) ..... 11
	2Mbit Firmware Hub (FWH) ..... 13
	Low Pin Count (LPC) Super Multi-I/O Chipset ..... 17
<b>Main Memory</b>	Maximum 2GB support
	RIMM Sockets B1 and B2 ..... 1
	RIMM Sockets A1 and A2 ..... 6
	Dual Channel PC800/PC600 RDRAM support
<b>Switches</b>	DSW Frequency Setting ..... 8
<b>Expansion Slots</b>	2 PCI Slots ..... 18
	1 Accelerated Graphics Port (AGP) Slot ..... 21
	1 Communications and Networking Riser (CNR) Slot ..... 16
<b>System I/O</b>	2 IDE Connectors (UltraDMA33/66/100 support) ..... 7
	1 USB2 Header (supports 2 USB ports) ..... 9
	1 Floppy Disk Drive Connector ..... 12
	1 Smart Card Connector ..... 15
	1 Parallel Port Connector ..... (Top) 24
	1 Serial COM1 Port Connector ..... (Bottom) 25
	1 Serial COM2 Port Connector ..... (Bottom) 23
	2 USB Port Connectors ..... (Bottom) 26
	1 RJ-45 Connector ..... (Top) 26
	1 PS/2 Mouse Connector ..... (Top) 27
	1 PS/2 Keyboard Connector ..... (Bottom) 27
<b>Audio</b>	AC'97 Audio CODEC ..... 20
	1 SPDIF Connector ..... 19
	1 Game/MIDI Connector ..... (Top) 22
	1 Line Out Connector ..... (Bottom) 22
	1 Line In Connector ..... (Bottom) 22
	1 Line Microphone Connector ..... (Bottom) 22
<b>Hardware Monitoring</b>	ASUS onboard chipset ..... 10
<b>Power</b>	ATX Power Supply Connector ..... 2
	ATX 12V Power Supply Connector ..... 4
<b>Special Feature</b>	Onboard LED ..... 14
<b>Form Factor</b>	MicroATX

# 2. FEATURES

## 2.2.1 Component Locations

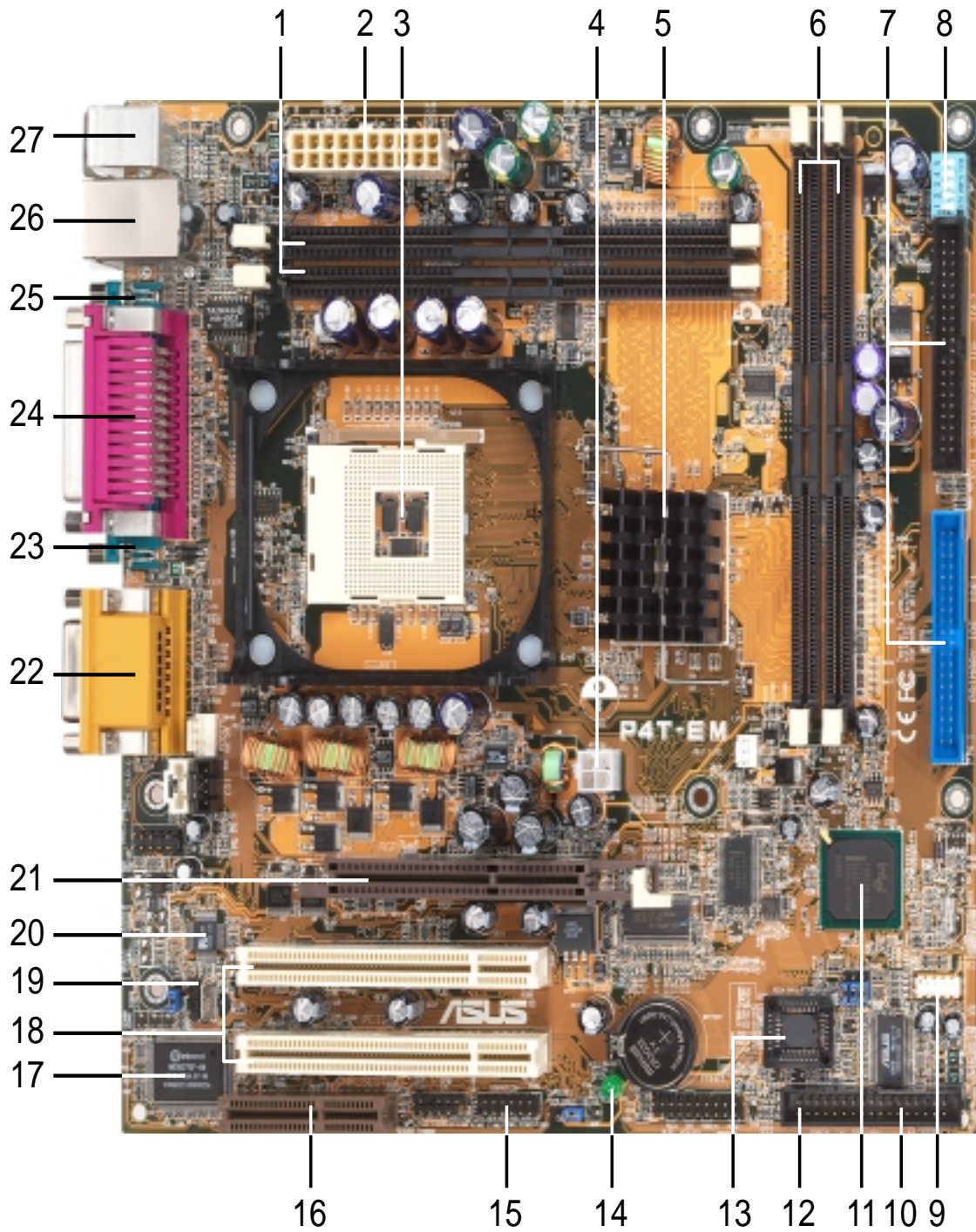

**2. FEATURES**  
Component Locations

# 3. HARDWARE SETUP

## 3.1 P4T-EM Motherboard Layout

**3. HW SETUP**  
Motherboard Layout

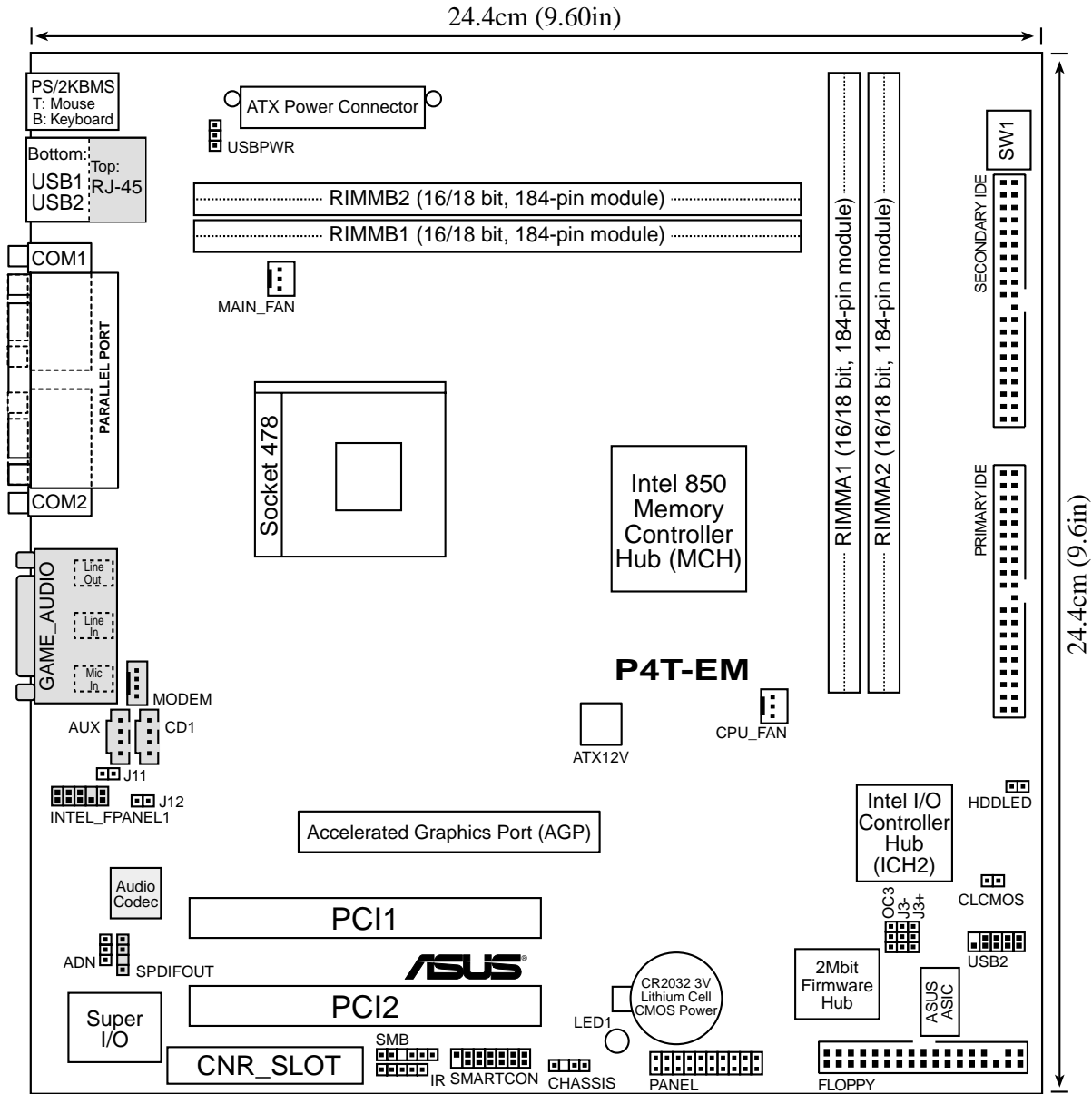

Grayed components are available only on certain models at the time of purchase.

# 3. HARDWARE SETUP

## 3.2 Layout Contents

### Motherboard Settings

- |                       |   |
|-----------------------|---|
| 1) SW1                | p. 17 Motherboard Frequency Settings                              |
| 2) LED                | p. 17 Onboard Power Signal  |
| 3) SW1 (Switches 1-5) | p. 18 CPU External Frequency (CPU/AGP/PCI)                        |
| 4) USBPWR             | p. 19 USB Device Wake-up (+5VSB/+5V)                              |
| 5) ADN                | p. 19 Onboard Audio (Enable/Disable) ( <i>audio models only</i> ) |
| 6) J3-J3+, OC3        | p. 20 USB2 / CNRUSB Selection (USB2/CNRUSB)                       |
| 7) J11, J12           | p. 20 Intel Front Panel Audio (Enable/Disable)                    |

### Memory, CPU and Expansion

- |                    |   |
|--------------------|---|
| 1) RIMMA1/A2/B1/B2 | p.21 184-Pin System Memory Support                  |
| 2) CPU             | p.23 Central Processing Unit (CPU)                  |
| 3) Heatsink        | p.24 CPU Heatsink Retention Module Installation     |
| 4) PCI1/2          | p.27 32-bit PCI Bus Expansion Slots                 |
| 5) AGP 4x          | p.29 Accelerated Graphics Port (AGP 4x) Slot        |
| 6) CNR             | p.29 Communications and Networking Riser (CNR) Slot |

### Connectors

- |                          |   |
|--------------------------|---|
| 1) PS2KBMS               | p.30 PS/2 Mouse Connector (6 pin female)                                  |
| 2) PS2KBMS               | p.30 PS/2 Keyboard Connector (6 pin female)                               |
| 3) PRINTER               | p.31 Parallel Port Connector (25 pin female)                              |
| 4) COM1, COM2            | p.31 Serial Port Connector (Two 9 pin male)                               |
| 5) USB                   | p.31 Universal Serial Bus Ports (Two 4 pin female)                        |
| 6) RJ-45                 | p.32 Fast-Ethernet Port Connector (8 pin female) ( <i>optional</i> )      |
| 8) GAME_AUDIO            | p.32 Joystick/MIDI Connector (15 pin female) ( <i>optional</i> )          |
| 9) PRIMARY/SECONDARY IDE | p.33 Primary/Secondary IDE Connectors (Two 40-1 pin)                      |
| 10) FLOPPY               | p.34 Floppy Disk Drive Connector (34-1pin)                                |
| 11) MAIN_FAN, CPU_FAN    | p.34 Fan Connectors (Two 3 pin)   |
| 12) USB2                 | p.35 USB Header (10-1 pin)  |
| 13) MODEM, CD_IN, AUX    | p.35 Internal Audio Connectors (Three 4 pin) ( <i>optional</i> )          |
| 14) SPDIFOUT             | p.36 Digital Audio Connector (4-1 pin) ( <i>optional</i> )                |
| 15) IR                   | p.36 Standard Infrared (SIR) Module Connector (5 pin) ( <i>optional</i> ) |
| 16) HDLED                | p.37 IDE Activity LED (2 pin)   |
| 17) SMB                  | p.37 System Management Bus Connector (5-1 pin)                            |
| 18) ATXPWR, ATX12V       | p.38 Power Supply Connector (20 pin) (4 pin)                              |
| 19) INTEL_FANL1          | p.39 Intel Front Panel Audio Connector (10-1 pin) ( <i>optional</i> )     |
| 20) SMARTCON             | p.39 ASUS SmartCard Connector (14-1 pin )                                 |
| 21) PLED (PANEL)         | p.40 System Power LED Lead (3-1 pin)                                      |
| 22) KEYLOCK (PANEL)      | p.40 Keyboard Lock Switch Lead (2 pin)                                    |
| 23) SPEAKER (PANEL)      | p.40 System Warning Speaker Connector (4 pin)                             |
| 24) MLED (PANEL)         | p.40 System Message LED (2 pin)   |
| 25) SMI (PANEL)          | p.40 System Management Interrupt Switch Lead (2 pin)                      |
| 26) PWRBTN (PANEL)       | p.40 ATX Power / Soft-Off Switch Lead (2 pin)                             |
| 27) RESET (PANEL)        | p.40 Reset Switch Lead (2 pin)  |

# 3. HARDWARE SETUP

---

## 3.3 Hardware Setup Procedure

**IMPORTANT:** Due to Pentium 4 CPU's power consumption requirement, an ATX12V power supply is recommended for this motherboard. For typical system configurations, an ATX12V power supply that can supply at least 230W and at least 8.5A on the +12V lead is required. For heavily-loaded configurations, an ATX12V power supply of 300W may be required.

Complete the following steps before using your computer:

1. Check motherboard settings
2. Install memory modules
3. Install the Central Processing Unit (CPU)
4. Install Expansion Cards
5. Connect ribbon cables, panel wires, and power supply cables
6. Configure the BIOS parameter settings

## 3.4 Motherboard Settings

This section tells you how to change motherboard function settings through the switches and/or jumpers.

**WARNING!** Computer motherboards and expansion cards contain very delicate Integrated Circuit (IC) chips. To protect them against damage from static electricity, you should follow some precautions whenever you work on your computer.

1. Unplug your computer when working on the inside.
2. Use a grounded wrist strap before handling computer components. If you do not have one, touch both of your hands to a safely grounded object or to a metal object, such as the power supply case.
3. Hold components by the edges and try not to touch the IC chips, leads or connectors, or other components.
4. Place components on a grounded antistatic pad or on the bag that came with the component whenever the components are separated from the system.
5. Ensure that the ATX power supply is switched off before you plug in or remove the ATX power connector on the motherboard.



# 3. HARDWARE SETUP

## 1) Motherboard Frequency Settings (SW1)

The motherboard frequency is adjusted through the DIP switches. The white block represents the switch's position. The illustration below shows all the switches in the OFF position.

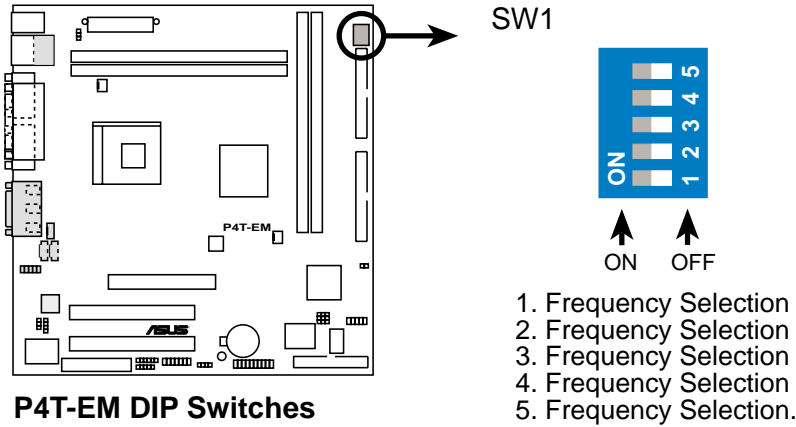

## 2) Onboard Power Signal (LED)

The board LED illuminates if power is connected and operating okay and when the system is in soft-off or suspend mode. Adding or removing devices is not advisable when the LED is lit, since the user risks electrical shock and/or disabling system configuration.

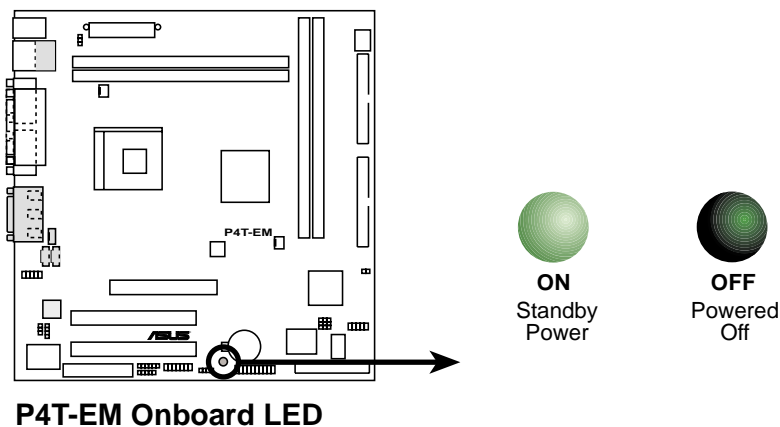

# 3. HARDWARE SETUP

## 3) CPU External Frequency Selection (SW1 Switches 1-5)

This option tells the clock generator what frequency to send to the CPU, DRAM, and the PCI bus. This allows the selection of the CPU's *External* frequency (or *BUS Clock*). The BUS Clock multiplied by the Frequency Multiple equals the CPU's *Internal* frequency (the advertised CPU speed). The system default is set at 100/66/ 33.

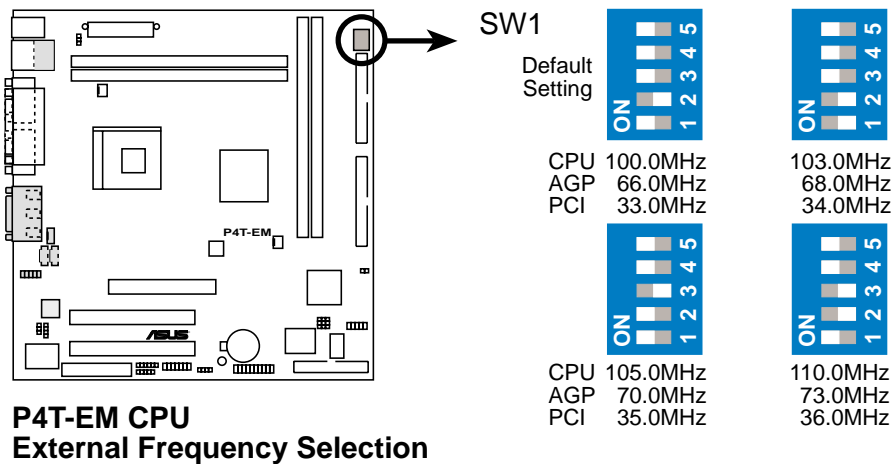

Frequency Table			DSW				
CPU	AGP	PCI	1	2	3	4	5
100	66	33	[ON]	[OFF]	[ON]	[ON]	[ON]
103	68	34	[OFF]	[OFF]	[ON]	[ON]	[ON]
105	70	35	[ON]	[ON]	[OFF]	[ON]	[ON]
110	73	36	[ON]	[OFF]	[OFF]	[ON]	[ON]

**WARNING!** Set the CPU frequency only to the recommended settings. Frequencies other than the recommended CPU bus frequencies are not guaranteed to be stable. Overclocking the processor is not recommended. It may result in a slower speed.

# 3. HARDWARE SETUP

## 4) USB Device Wake-up (USBPWR)

The jumpers are set to +5V as the default to allow wake up from the S1 sleep state (CPU stopped; RAM refreshed; system running in low power mode) using the connected USB devices. Set the jumpers to +5VSB to allow wake up from S3 sleep state (no power to CPU; RAM in slow refresh; power supply in reduced power mode). The default setting for the three jumpers is 2-3 to select +5V (because not all computers have the appropriate power supply to support the other mode).

### NOTES:

1. This feature requires an ATX power supply that can supply at least 2A on the +5VSB lead when these jumpers are set to +5VSB. Otherwise, the system does not power up.
2. The total current consumed must NOT exceed the power supply capability (+5VSB) whether under normal working conditions or in sleep mode.

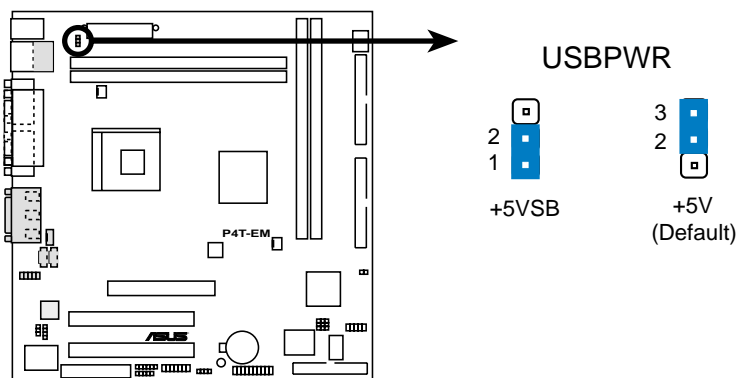

**P4T-EM USB Device Wake Up**

## 5) Onboard Audio Setting (ADN) (*audio models only*)

The onboard Audio Codec may be enabled or disabled using these jumpers. Disable the onboard Audio Codec if using a PCI audio card on any of the expansion slots or a primary audio/modem CNR on a CNR slot (see CNR Slot later in this section).

<u>Setting</u>	<u>ADN</u>
Enable	[1-2] (default)
Disable	[2-3]

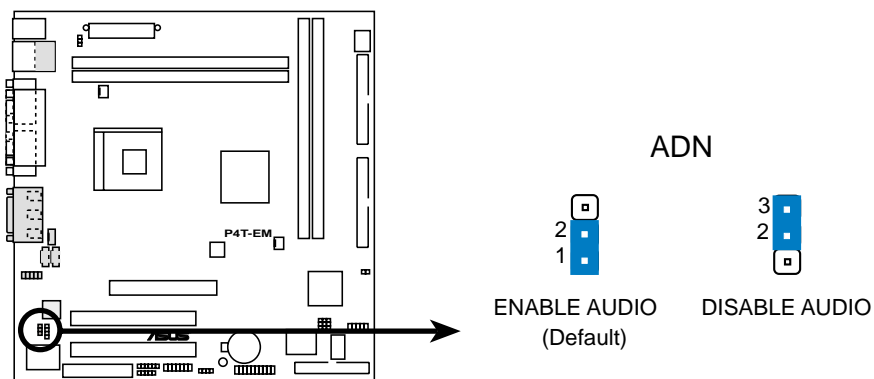

**P4T-EM AUDIO Setting**

# 3. HARDWARE SETUP

## 6) USB2 / CNRUSB Selection (J3-J3+, OC3)

The CNR slot can support an optional USB hub CNR card. Three jumpers are used to control selection of USB or CNR functions: *J3-*, *J3+* and *OC3*. The factory default setting is for standard USB2 control. If a USB hub CNR card is used, reset these jumpers to CNRUSB setting shown below.

**IMPORTANT!** Always set all three jumpers accordingly when selecting a device.

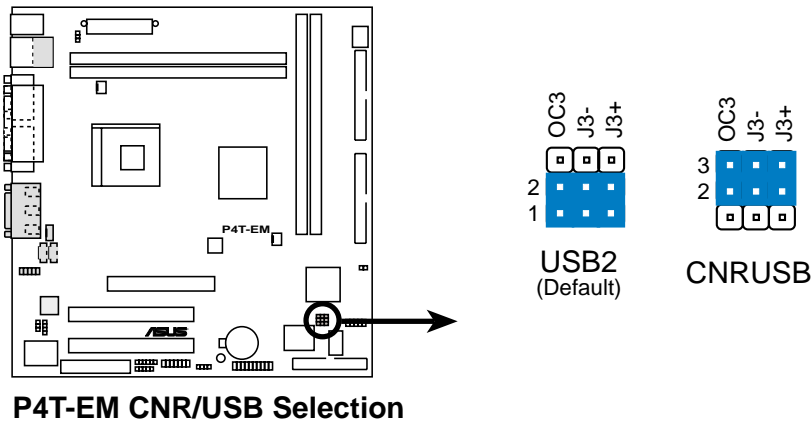

## 7) Intel Front Panel Audio Selection (J11, J12)

The motherboard ships with two jumper caps *on* both J11 and J12, adjacent to the INTEL\_FPANEL1 connector. The caps-on default completes the circuit for use of regular audio external connectors, ie.: Line\_out. If using the INTEL\_FPANEL1 cable and/or front panel, then remove J11 and J12 jumper caps. Do not remove the jumper caps unless the INTEL\_FPANEL1 cable connector is used. (See page 39 for the INTEL\_FPANEL1 connector.)

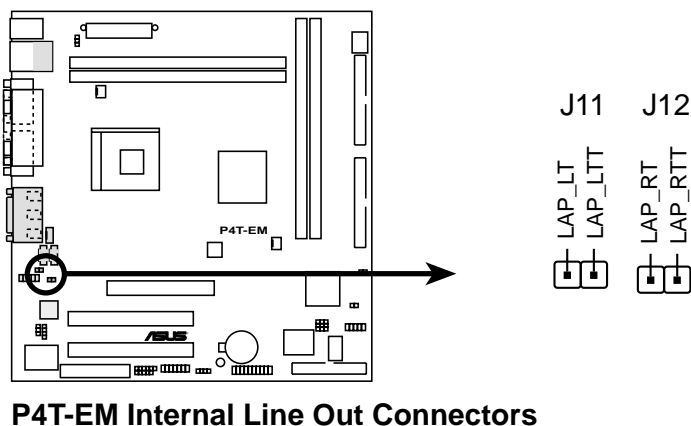

# 3. HARDWARE SETUP

## 3.5 System Memory

**NOTE:** No hardware or BIOS setup is required after adding or removing memory.

This motherboard has four 184-pin **Rambus Inline Memory Modules (RIMM)** sockets. These sockets support 64Mbit, 128Mbit, and 256Mbit Direct RDRAM technologies.

Location	Memory Module		Subtotal
RIMMA1 (Rows 0&1)	<input type="checkbox"/> RDRAM <input type="checkbox"/> C-RIMM (use when socket will not be populated)	x 1	
RIMMA2 (Rows 2&3)	<input type="checkbox"/> RDRAM <input type="checkbox"/> C-RIMM (use when socket will not be populated)	x 1	
RIMMB1 (Rows 4&5)	<input type="checkbox"/> RDRAM <input type="checkbox"/> C-RIMM (use when socket will not be populated)	x 1	
RIMMB2 (Rows 6&7)	<input type="checkbox"/> RDRAM <input type="checkbox"/> C-RIMM (use when socket will not be populated)	x 1	
<b>TOTAL SYSTEM MEMORY</b> (2GB Max)		=	

### IMPORTANT

1. The memory configuration of channel A (RIMMA1 and RIMMA2) and channel B (RIMMB1 and RIMMB2) must be identical (see below).
2. C-RIMMs (Continuity RIMM) must be used to complete the sockets that are not populated by RDRAMs. A C-RIMM is necessary to avoid breaking the signal lines, which are a serial connection in a Rambus interface, such as used in this motherboard. This assures the electrical integrity of a Rambus interface.
3. When C-RIMMs are required, it is recommended that they be inserted into RIMMA2 and RIMMB2.

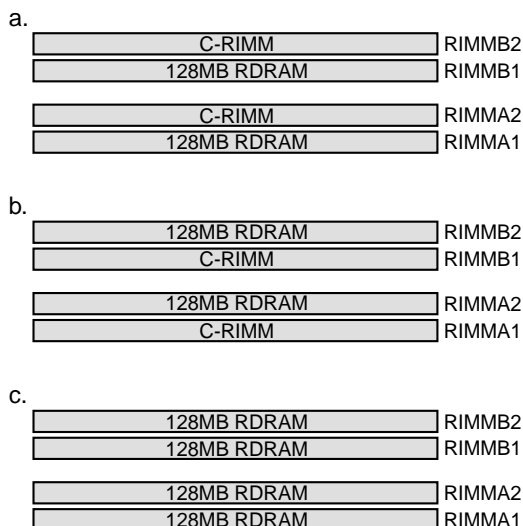

**NOTE:** When using only two memory modules, it is recommended that you use configuration **a**.

# 3. HARDWARE SETUP

## 3.5.1 Installing Memory

The memory module (RIMM) will fit in only one orientation.

**IMPORTANT:** Do not touch the memory module's connectors. Handle the module only by the edges.

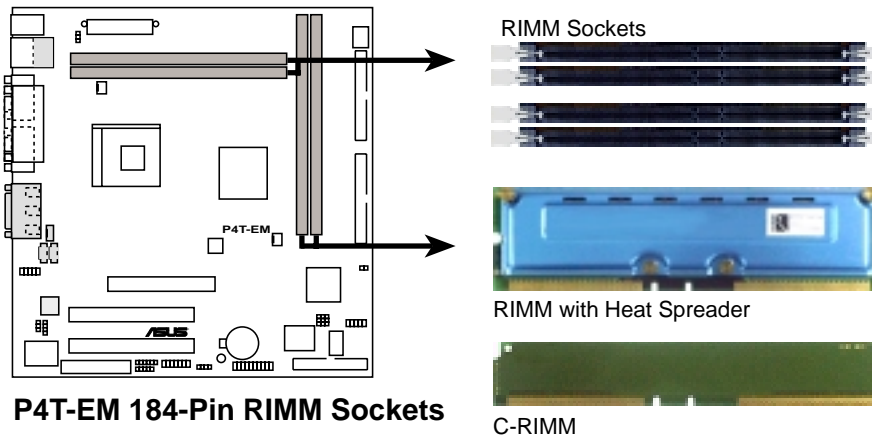

1. Make sure that the notch keys in the module are aligned with the small ribs inside the RIMM sockets.

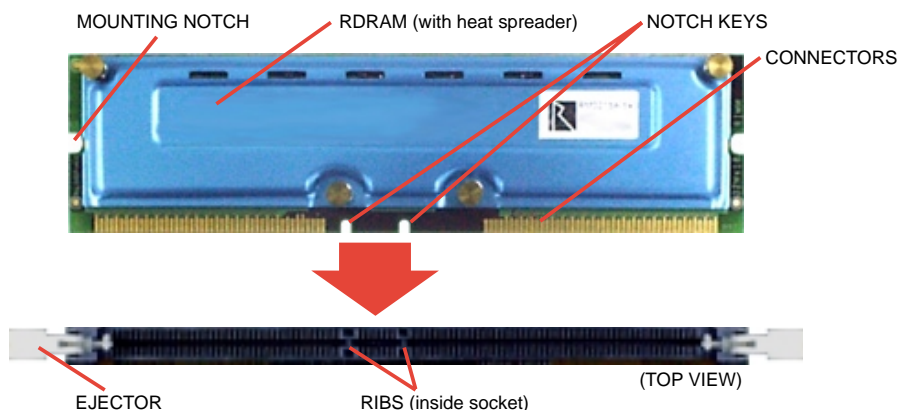

2. With the ejectors in the open position (as shown), push down gently but firmly on the memory module until it snaps into place. The guides on the socket's ejectors should go through the two mounting notches on the module and the ejectors should close. If necessary, push the ejectors inward to secure the module in place.

### Removing Memory

To release a memory module, push both ejectors outward and pull the module straight up and out of the RIMM sockets.

**WARNING!** RIMM modules become extremely hot during operation. To reduce the risk of personal injury from hot surfaces, allow the modules to cool off before removing them.

# 3. HARDWARE SETUP

## 3.6 Central Processing Unit (CPU)

The motherboard provides a ZIF Socket 478, for CPU installation. A fan and heat-sink should be attached to the CPU to prevent overheating. Purchase and install a fan and heatsink before turning on the system.

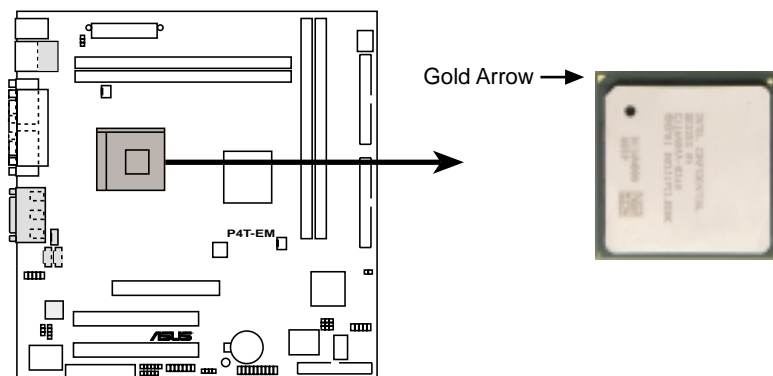

**P4T-EM Socket 478**

1. Locate the Socket 478 and open it by pulling the lever gently sideways away from the socket. Then lift the lever upwards. The socket lever must be fully opened (90 to 100 degrees).
2. Insert the CPU with the correct orientation. The **gold arrow** of the CPU must be oriented toward the inner corner of the socket base nearest to the hinge of the lever handle.

**CAUTION!** The CPU fits in one orientation and should drop easily into place. **Do not force the CPU** into the socket to avoid bending the pins. If the CPU does not fit, check its alignment and look for bent pins.

3. Once completely inserted, press the CPU firmly and close the socket lever until it snaps into its locked position.
4. Install an Intel fan heatsink.

**CAUTION!** Take care not to scrape the motherboard surface when mounting a clamp-style processor fan, or else damage may occur. When mounting a heatsink onto your CPU, make sure that exposed CPU capacitors do not touch the heatsink, or else damage may occur! Refer to heatsink/CPU documentation.

**NOTE:** Do not forget to set the correct Bus Frequency and Multiple (frequency multiple setting is available only on unlocked processors) for your Socket 478 processor or else boot-up may not be possible. Socket 478 processors provide internal thermal sensing: a socket mounted thermal resistor is not needed.

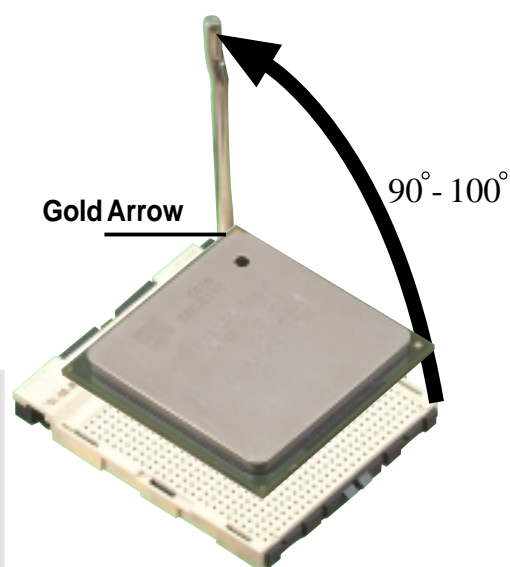

# 3. HARDWARE SETUP

## 3.6.1 Installing the Heatsink and Fan

The Intel® Pentium® 4 478 / Northwood Processor comes complete with a specially designed heatsink and fan assembly to ensure optimum thermal condition and performance. If a CPU is purchased separately, only use an Intel certified heatsink and fan.

### Step 1: Mount the Heatsink

Place the **heatsink** on top of the installed CPU. Make sure that the **heatsink** fits properly on the **retention module base**. Note that the **retention module base** is already installed on the motherboard.

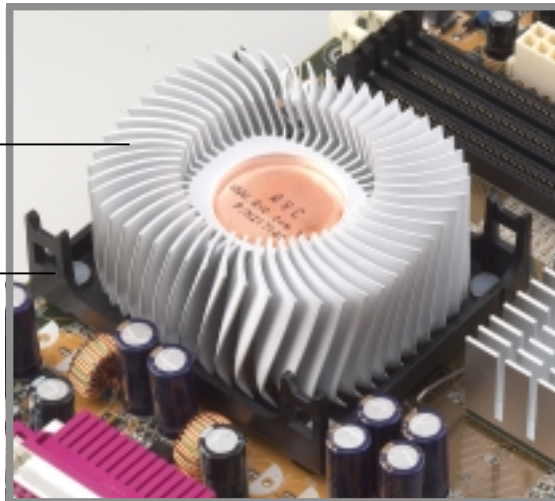

CPU Heatsink

Retention Module Base

**WARNING!** Be sure that there is sufficient air circulation across the processor's heatsink by regularly checking that your CPU fan is working. Without sufficient circulation, the processor could overheat and damage both the processor and the motherboard.

**NOTE:** If using a rectangular heatsink, use a model with fin-ends that project and terminate on the *longer* side of the unit, not on the shorter side.



# 3. HARDWARE SETUP

## Step 2: Mount the Fan

Position the **fan** with the **retention mechanism** on top of the heatsink. Align and snap the four hooks of the retention mechanism to the holes on each corner of the module base. Carefully fit the fan and retention mechanism assembly perfectly to the heatsink and module base, otherwise you cannot snap the hooks into the holes. Keep the retention locks lifted upward while fitting the retention mechanism to the module base.

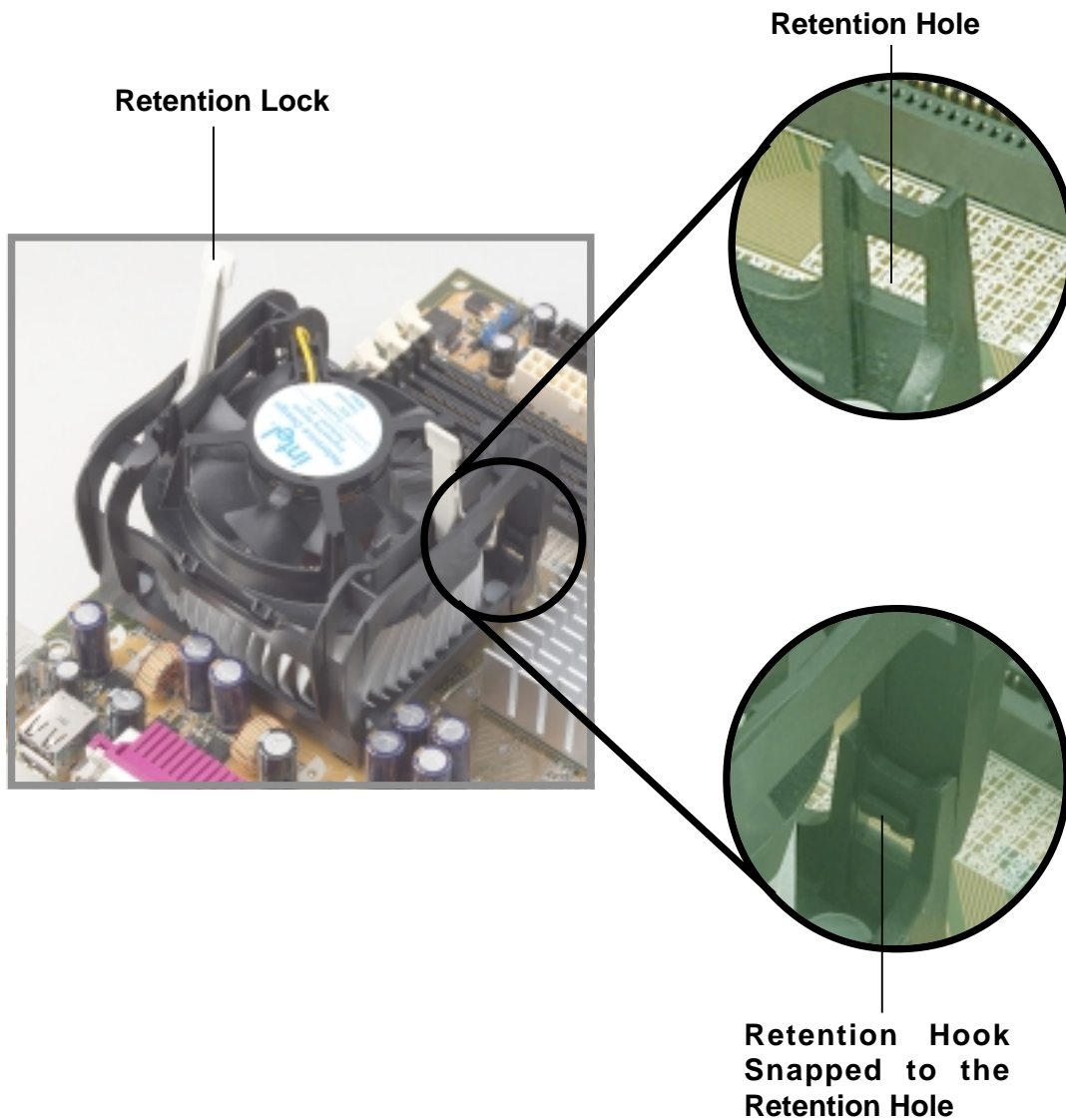

# 3. HARDWARE SETUP

---

## Step 3: Lock the Retention Mechanism

Push down the locks on the retention mechanism to secure the heatsink and fan to the module base. When secure, the retention locks should point to opposite directions. The heatsink should entirely cover the CPU. With the added weight of the CPU fan and heatsink locking brace, no extra force is required to keep the CPU in place. Connect the CPU fan cable to the fan connector.

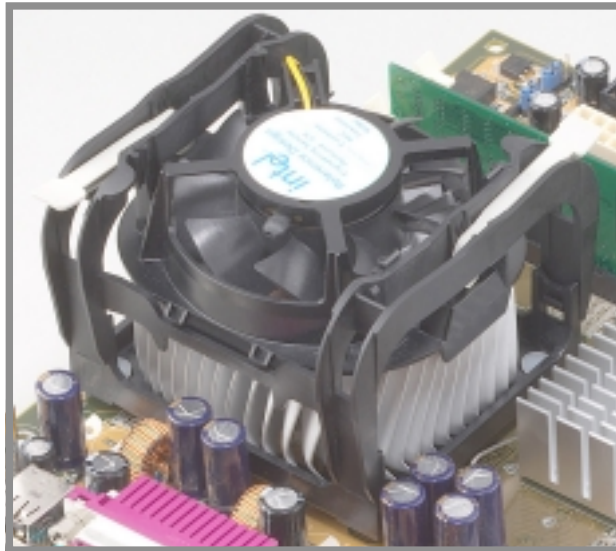

## Step 4: Connect the CPU Fan Cable

With the fan, heatsink, and the retention mechanism in place, attach the CPU fan cable to the connector on the motherboard labelled CPUFAN.

CPU Fan Connector (CPUFAN)

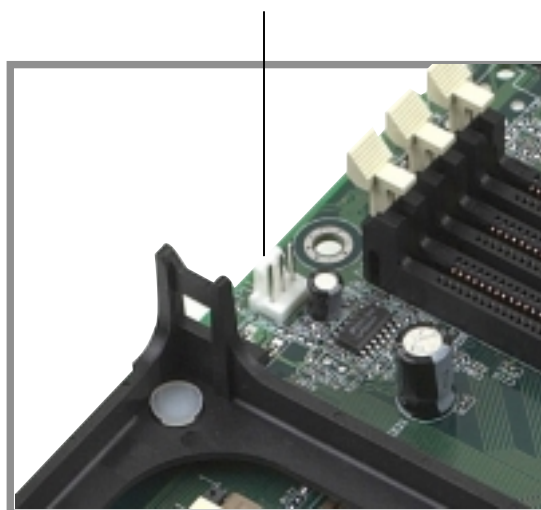

# 3. HARDWARE SETUP

## 3.7 Expansion Cards

### 3.7.1 Expansion Card Installation Procedure

1. Read the documentation for your expansion card and make any necessary hardware or software settings for your expansion card, such as jumpers.
2. Remove your computer system's cover and the bracket plate on the slot you intend to use. Keep the bracket for possible future use.
3. Carefully align the card's connectors and press firmly.
4. Secure the card on the slot with the screw you removed above.
5. Replace the computer system's cover.
6. Set up the BIOS if necessary  
(such as *IRQ XX Reserved for Legacy Device: Yes* in **4.4.3 PCI Configuration**)
7. Install the necessary software drivers for your expansion card.

**WARNING!** Unplug your power supply when adding or removing expansion Cards or other system components. Failure to do so may cause severe damage to both your motherboard and expansion cards. (See **3.3 Hardware Setup Procedure** for more information).

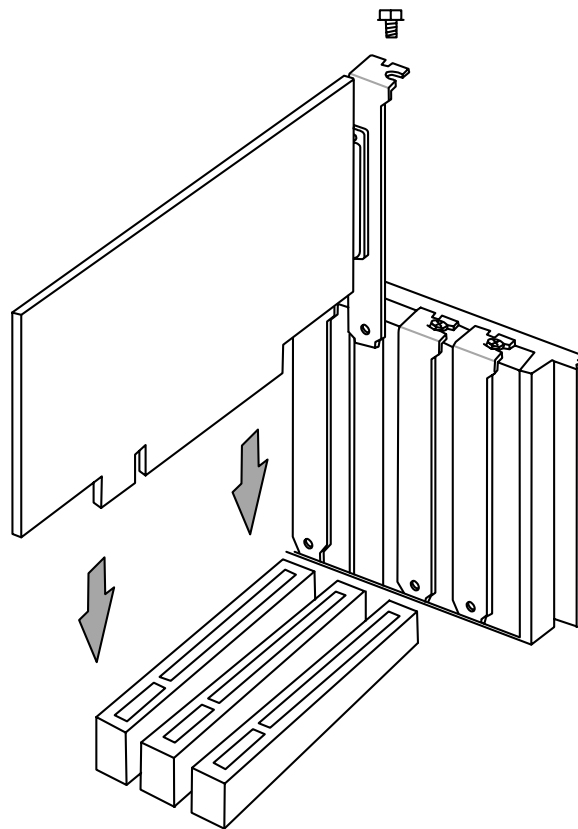

# 3. HARDWARE SETUP

## 3.7.2 Assigning IRQs for Expansion Cards

Some expansion cards need an IRQ to operate. Generally, an IRQ must be exclusively assigned to one use. In a standard design, there are 16 IRQs available but most of them are already in use, leaving 6 IRQs free for expansion cards. If your motherboard has **PCI** audio onboard, an additional IRQ will be used. If your motherboard also has **MIDI** enabled, another IRQ will be used, leaving 4 IRQs free.

### Standard Interrupt Assignments

IRQ	Priority	Standard Function
0	1	System Timer
1	2	Keyboard Controller
2	N/A	Programmable Interrupt
3*	11	Communications Port (COM2)
4*	12	Communications Port (COM1)
5*	13	Sound Card (sometimes LPT2)
6	14	Floppy Disk Controller
7*	15	Printer Port (LPT1)
8	3	System CMOS/Real Time Clock
9*	4	ACPI Mode when enabled
10*	5	IRQ Holder for PCI Steering
11*	6	IRQ Holder for PCI Steering
12*	7	PS/2 Compatible Mouse Port
13	8	Numeric Data Processor
14*	9	Primary IDE Channel
15*	10	Secondary IDE Channel

\*These IRQs are usually available for ISA or PCI devices.

### Interrupt Request Table for this Motherboard

	INT-A	INT-B	INT-C	INT-D	INT-E	INT-F	INT-G	INT-H
PCI slot 1	—	—	—	—	—	used	—	—
PCI slot 2	—	—	—	—	—	—	used	—
AGP slot	used	—	—	—	—	—	—	—
USB HC0	—	—	—	used	—	—	—	—
USB HC1	—	—	—	—	—	—	—	used
SMB	—	shared	—	—	—	—	—	—
AC'97	—	shared	—	—	—	—	—	—
LAN	—	—	—	—	used	—	—	—

**IMPORTANT:** If using PCI cards on shared slots, make sure that the drivers support “Share IRQ” or that the cards do not need IRQ assignments. Conflicts will arise between the two PCI groups that will make the system unstable or cards inoperable.

# 3. HARDWARE SETUP

## 3.7.3 Accelerated Graphics Port (AGP 4x)

This motherboard provides an accelerated graphics port (AGP 4x) to support a new generation of AGP graphics cards with ultra-high memory bandwidth.

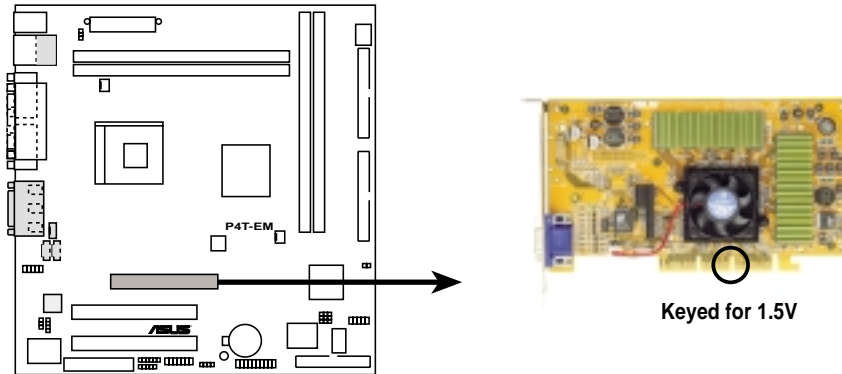

**P4T-EM Accelerated Graphics Port (AGP )**

**IMPORTANT:** Only 1.5V AGP cards are supported. ASUS® AGP 4X cards are rated for both 1.5 and 3.3 Volts. Early AGP cards only operate at 3.3 volts and will not fit properly into the new AGP 4X slots. See examples of both types below:

An early 3.3V AGP card:  
Do not use.

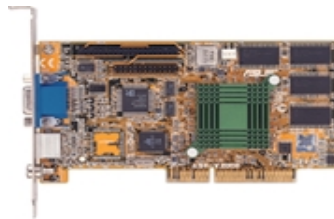

A new 1.5 / 3.3V AGP card:  
OKAY to use.



**3. HW SETUP**  
Expansion Cards

## 3.7.4 Communications and Networking Riser (CNR)

This connector supports specially designed network, audio, or modem riser cards. Main processing is done through software and controlled by the motherboard's system chipset. This provides upgradeable network, audio, and/or modem solutions at an incredibly low cost.

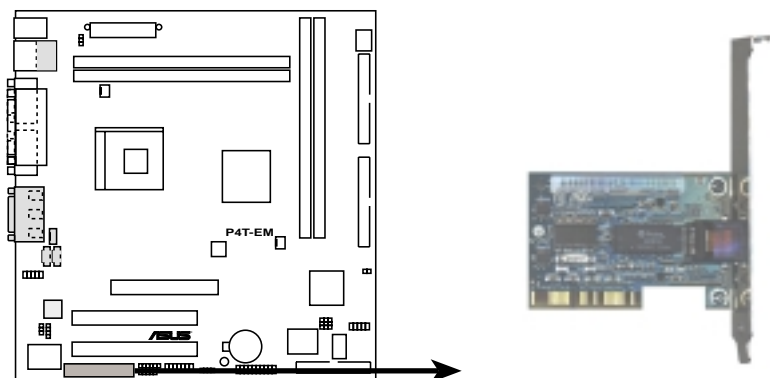

**P4T-EM Communication & Networking Riser Connectors**

# 3. HARDWARE SETUP

## 3.8 External Connectors

**WARNING!** Some pins are used for connectors or power sources. These are clearly distinguished from jumpers in the Motherboard Layout. Placing jumper caps over these connector pins will cause damage to your motherboard.

**IMPORTANT:** Ribbon cables should always be connected with the red stripe to Pin 1 on the connectors. Pin 1 is usually on the side closest to the power connector on hard drives and CD-ROM drives, but may be on the opposite side on floppy disk drives. Check the connectors before installation because there may be exceptions. IDE ribbon cables must be less than 46 cm (18 in.), with the second drive connector no more than 15 cm (6 in.) from the first connector.

### 1) PS/2 Mouse Connector (Green 6-pin PS2KBMS)

The system will direct IRQ12 to the PS/2 mouse if one is detected. If one is not detected, expansion cards can use IRQ12. See **PS/2 Mouse Function Control** in *4.4 Advanced Menu*.

PS/2 Mouse (6-pin female)

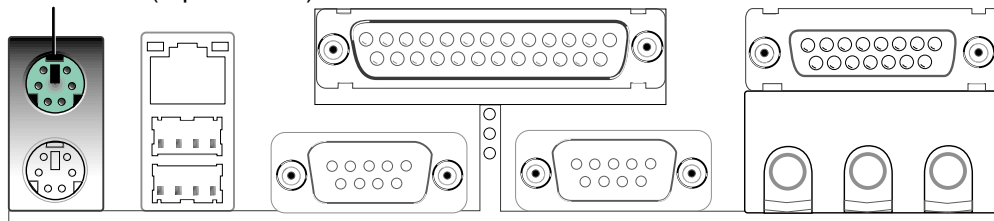

### 2) PS/2 Keyboard Connector (Purple 6-pin PS2KBMS)

This connection is for a standard keyboard using an PS/2 plug (mini DIN). **This connector will not allow standard AT size (large DIN) keyboard plugs. You may use a DIN to mini DIN adapter on standard AT keyboards.**

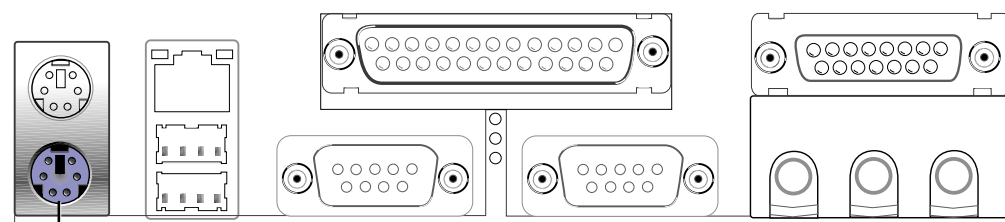

PS/2 Keyboard (6-pin female)

# 3. HARDWARE SETUP

## 3) Parallel Port Connector (Burgundy 25-pin PRINTER)

You can enable the parallel port and choose the IRQ through **Onboard Parallel Port** (see **4.4.2 I/O Device Configuration**).

**NOTE:** Serial printers must be connected to the serial port.

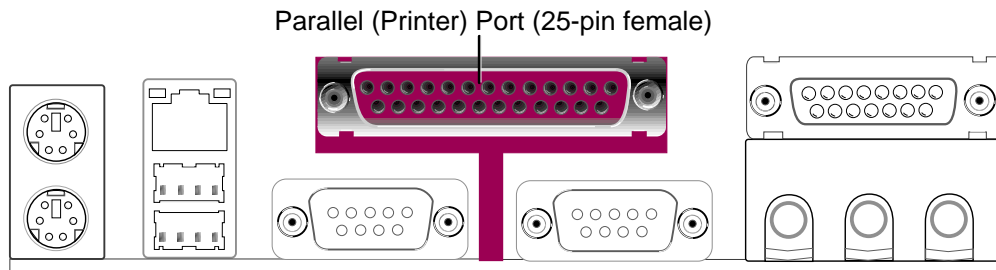

## 4) Serial Port Connectors (Teal/Turquoise 9-pin COM1, 9-pin COM2)

Two serial ports are ready for a mouse or other serial devices. See **Onboard Serial Port 1/2** in **4.4.2 I/O Device Configuration** for settings.

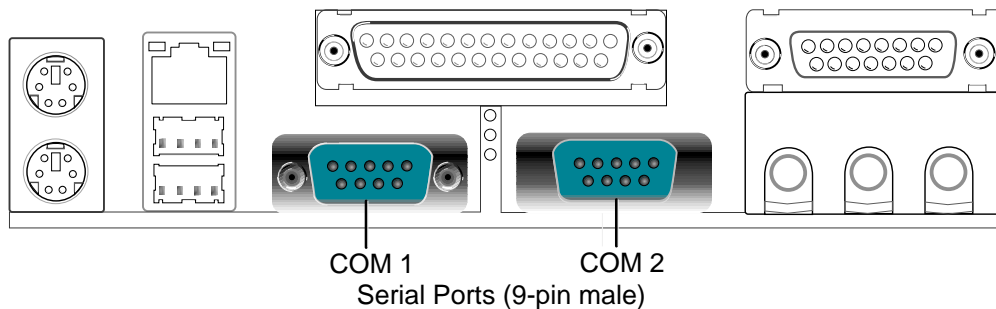

## 5) Universal Serial Bus Ports (Black two 4 pin USB)

Two USB ports are available for connecting USB devices. For additional USB ports, you can use the USB headers (see **USB Headers** later in this section).

**NOTE: USB Function** (see **4.4.3 PCI Configuration**) must be *Enabled* to use these ports.

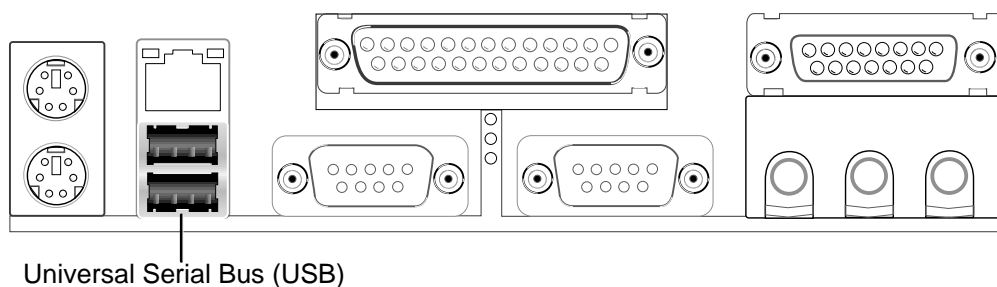



# 3. HARDWARE SETUP

## 6) Fast-Ethernet Port Connector (RJ-45)

An optional RJ-45 connector is located on top of the USB connectors. The connector allows the motherboard to connect to a Local Area Network (LAN) through a network hub.

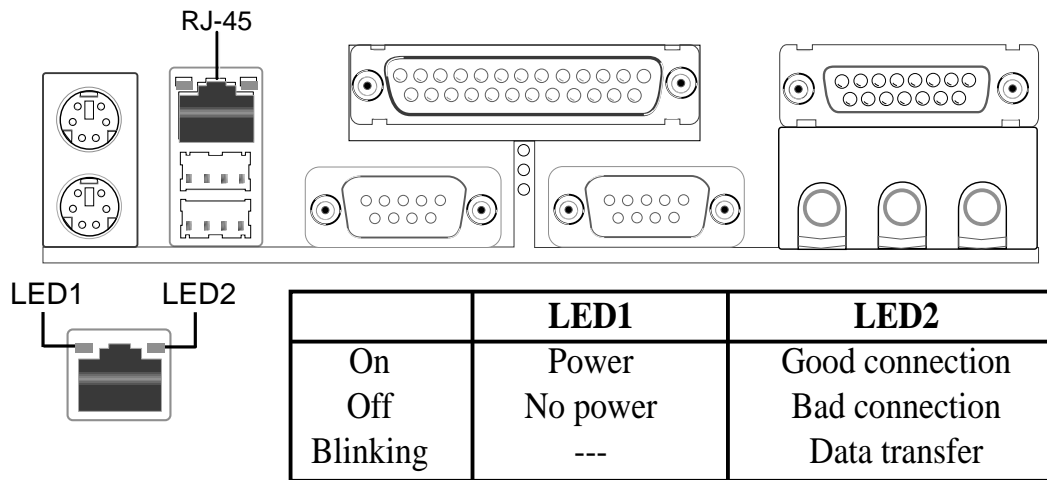

## 7) Joystick/MIDI Connector (15 pin Female GAME\_AUDIO)

You may connect game joysticks or game pads to this connector for playing games. Connect MIDI devices for playing or editing audio.

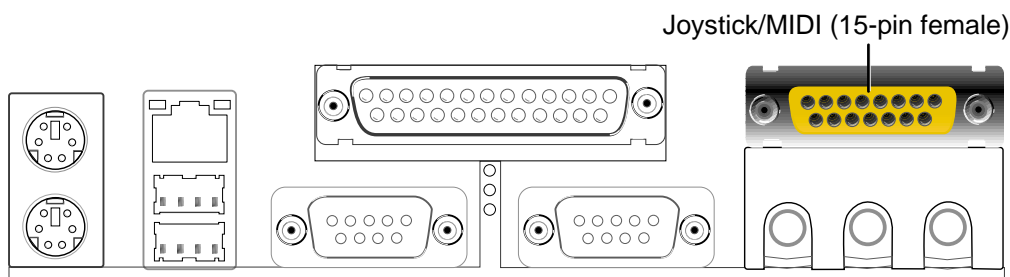

## 8) Audio Port Connectors (Three 1/8" Female LINE IN, LINE OUT, MIC)

**Line Out** can be connected to headphones or preferably powered speakers. **Line In** allows tape players or other audio sources to be recorded by your computer or played through the **Line Out**. **Mic** allows microphones to be connected for inputting voice.

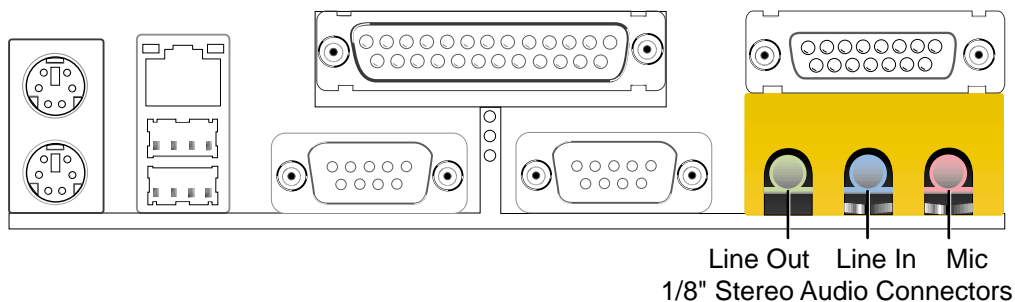



# 3. HARDWARE SETUP

## 9) Primary (Blue) / Secondary IDE Connectors (Two 40-1pin IDE)

These connectors support the provided IDE hard disk ribbon cable. Connect the cable's blue connector to the motherboard's primary (recommended) or secondary IDE connector. Then connect the gray connector to your UltraDMA/100 slave device (hard disk drive) and the black connector to your UltraDMA/100 master device. It is recommended that non-UltraDMA/100 devices be connected to the secondary IDE connector. If you install two hard disks, you must configure the second drive to Slave mode. Please refer to your hard disk documentation for the jumper settings. BIOS now supports specific device bootup (see **4.6 Boot Menu**). **(Pin 20 is removed to prevent wrong orientations).**

**TIP:** You may configure two hard disks to be both Masters with two ribbon cables – one for the primary IDE connector and another for the secondary IDE connector. You may install one operating system on an IDE drive and another on a SCSI drive and select the boot disk through **4.6 Boot Menu**.

**IMPORTANT:** UltraDMA/100 IDE devices must use a 40-pin 80-conductor IDE cable for 100MByte/sec transfer rates.

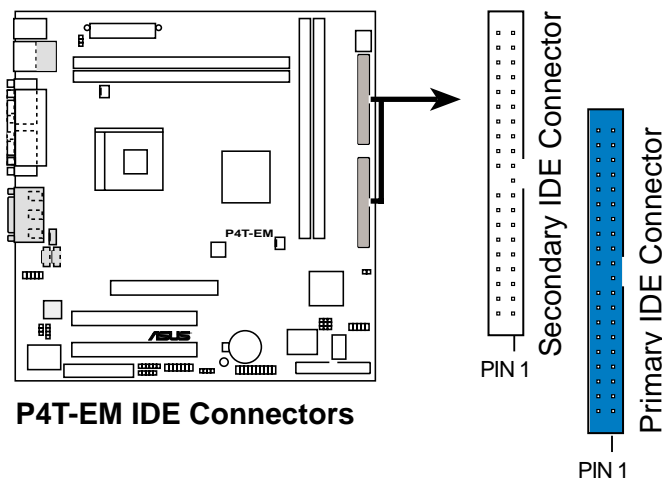

**NOTE:** Orient the red markings (usually zigzag) on the IDE ribbon cable to PIN 1.

# 3. HARDWARE SETUP

## 10) Floppy Disk Drive Connector (34-1pin FLOPPY)

This connector supports the provided floppy drive ribbon cable. After connecting the single end to the board, connect the two plugs on the other end to the floppy drives. (**Pin 5 is removed to prevent inserting the cable into the wrong orientation**).

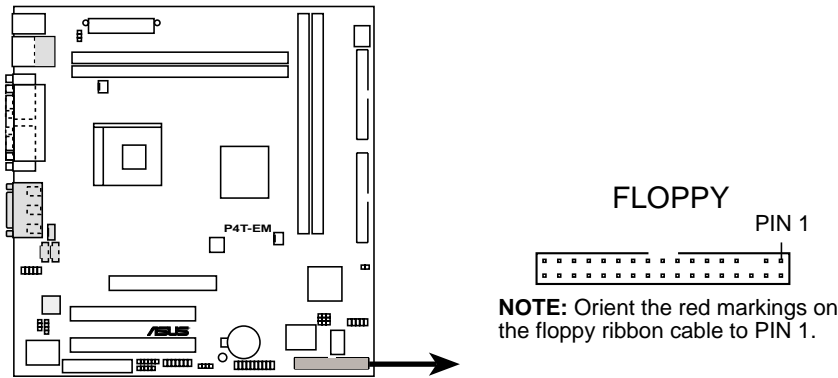

P4T-EM Floppy Disk Drive Connector

## 11) Fan Connectors (3 pin MAIN\_FAN, CPU\_FAN)

These connectors support cooling fans of 350mA (4.2 Watts) or less. Orientate the fans so that the heat sink fins allow airflow to go across the onboard heat sink(s) instead of the expansion slots. Depending on the fan manufacturer, the wiring and plug may be different. The red wire should be positive, while the black should be ground. Connect the fan's plug to the board taking into consideration the polarity of the connector.

**NOTE:** The "Rotation" signal is to be used only by a specially designed fan with rotation signal. The Rotations per Minute (RPM) can monitored using a utility such as ASUS PC Probe or Intel LDCM.

**WARNING!** The CPU and/or motherboard will overheat if there is no airflow across the CPU and onboard heatsinks. Damage may occur to the motherboard and/or the CPU fan if these pins are incorrectly used. **These are not jumpers, do not place jumper caps over these pins.**

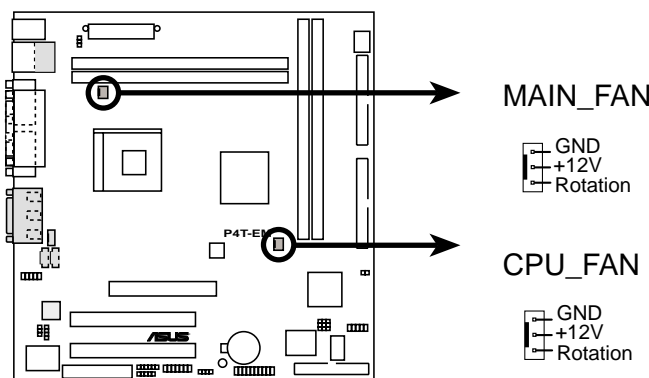

P4T-EM 12-Volt Cooling Fan Power

# 3. HARDWARE SETUP

## 12) USB Headers (10-1 pin USB2)

If the USB Ports on the back panels are inadequate, a USB header is available for two additional USB ports. Connect the 10-1 pin ribbon cable from the provided 2-port USB connector set to the midboard 10-1 pin USB header and mount the USB connector set to an open slot on your chassis.

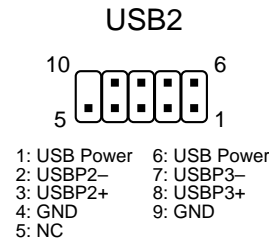
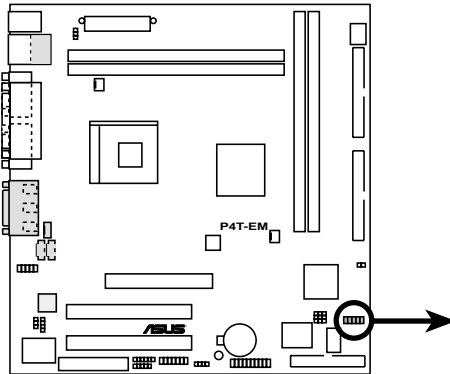

**P4T-EM USB Headers**

## 13) Internal Audio Connectors (4-pin MODEM, CD\_IN, AUX)

These connectors allow you to receive stereo audio input from such audio-visual sources as a CD-ROM input, or MPEG card.

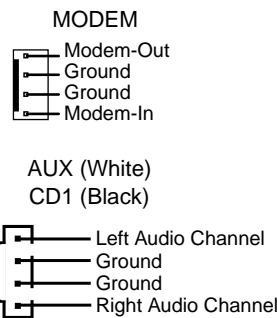
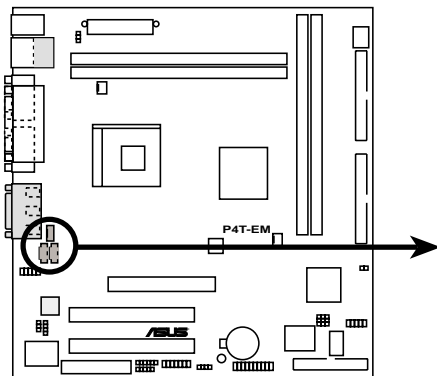

**P4T-EM Internal Audio Connectors**

# 3. HARDWARE SETUP

## 14) Digital Audio Connector (4-1 pin SPDIFOUT) (optional)

This connector supports an SPDIF audio module that processes digital instead of analog audio output. Connect one end of the audio cable to the SPDIFOUT connector on the motherboard and the other end to the SPDIF module. **NOTE:** The SPDIF module must be purchased separately.

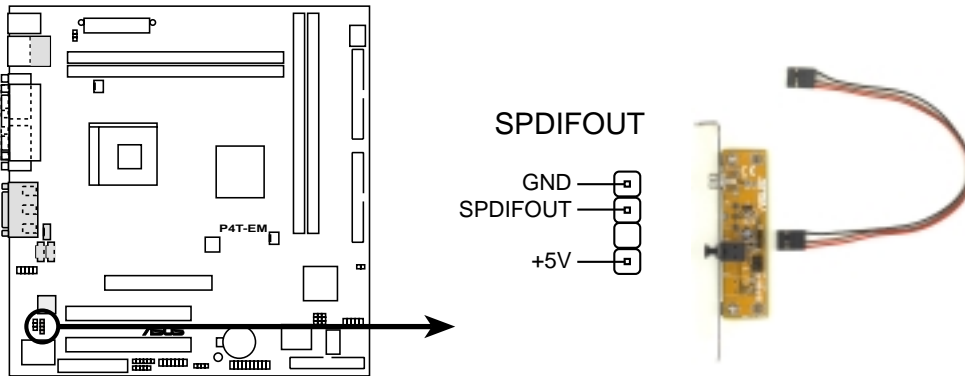

**P4T-EM Digital Audio Connector**

## 15) Standard and Consumer Infrared (SIR) Module Connector (5-pin IR)

This connector supports an optional wireless transmitting and receiving infrared module. This module mounts to a small opening on system cases that support this feature. You must also configure the setting through **UART2 Use Infrared** (see **4.4.2 I/O Device Configuration**) to select whether UART2 is directed for use with COM2 or IrDA. Use the five pins as shown in Back View and connect a ribbon cable from the module to the motherboard's SIR connector according to the pin definitions.

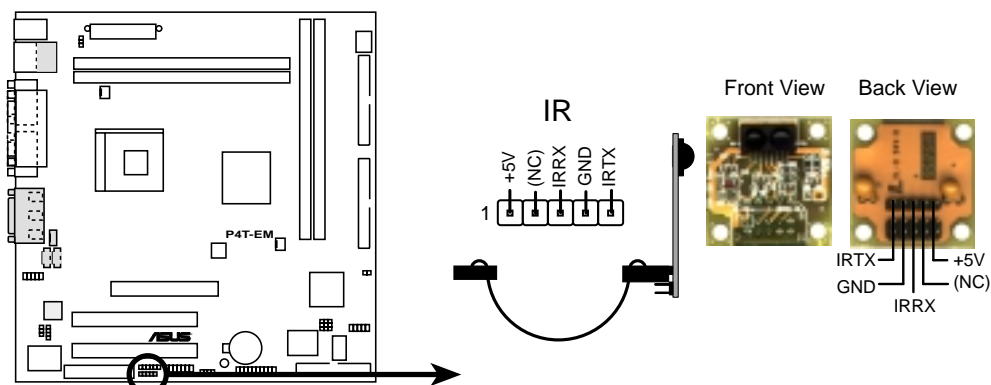

**P4T-EM Infrared Module Connector**

# 3. HARDWARE SETUP

## 16) IDE Activity LED (2-pin HDLED)

This connector supplies power to the cabinet's IDE activity LED. Read and write activity by devices connected to the Primary/Secondary IDE and Primary/Secondary ATA100 connectors will cause the LED to light up.

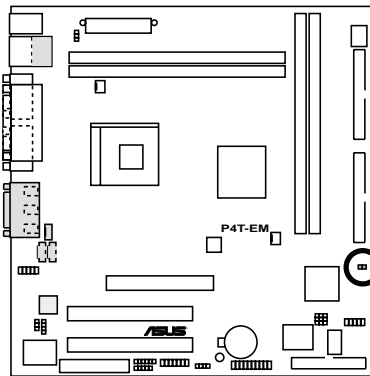

**P4T-EM HDD Activity LED**

HDDLED



**TIP:** If the case-mounted LED does not light, try reversing the 2-pin plug.

## 17) SMB Connector (5-1 pin SMB)

This connector allows you to connect SMBus (System Management Bus) devices. SMBus devices communicate by means of the SMBus with an SMBus host and/or other SMBus devices. SMBus is a specific implementation of an I2C bus, which is a multi-device bus; that is, multiple chips can be connected to the same bus and each one can act as a master by initiating data transfer.

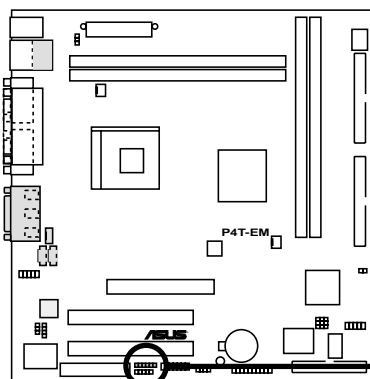

**P4T-EM SMBus Connector**

SMB

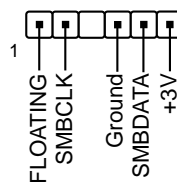

# 3. HARDWARE SETUP

## 18) Power Supply Connectors (20-pin block ATXPWR) (4-pin ATX12V) (6 pin block AUXPWR (optional))

These connectors supply ATX 12V power. Each power supply plug inserts in one orientation only. Push down firmly and make sure the pins are aligned.

**IMPORTANT:** Make sure that your ATX 12V power supply (minimum recommended wattage: 230 watts; 300W for a fully-configured system) can supply at least 20 amperes on the +5-volt lead and at least 720mA on the +5-volt standby lead (+5VSB). Your system may become unstable/unreliable and may experience difficulty in powering up if your power supply is inadequate. For Wake-On-LAN support, your ATX power supply (minimum recommended wattage: 230watts) must supply at least 720mA +5VSB.

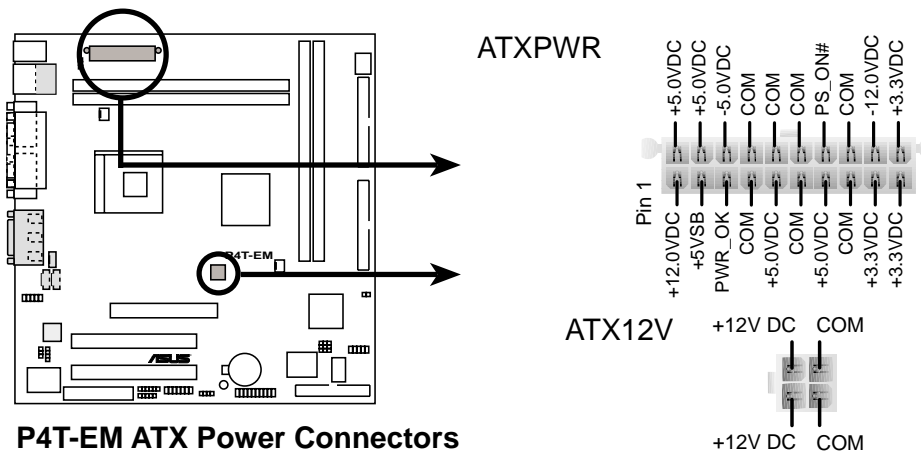

P4T-EM ATX Power Connectors

# 3. HARDWARE SETUP

## 19) Intel Front Panel Audio Connector (10-1 pin INTEL\_FPANEL1)

Attach the Intel Front Panel audio cable to the INTEL\_FPANEL1 connector for audio control. Remove the adjacent jumper caps, J11 and J12, when using the INTEL\_FPANEL1. (See page 20 for more information on the jumpers.)

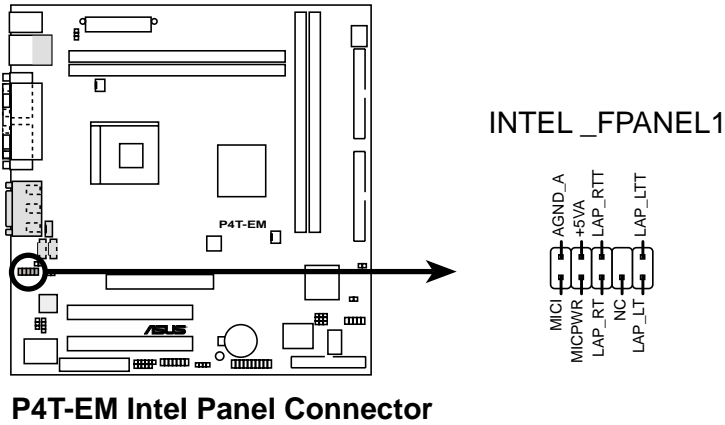

## 20) ASUS SmartCard Connector (14-1 pin SMARTCON)

This connector attaches to an optional SmartCard reader device. The SmartCard reader permits data access from the memory chip of PC/SC smart cards.

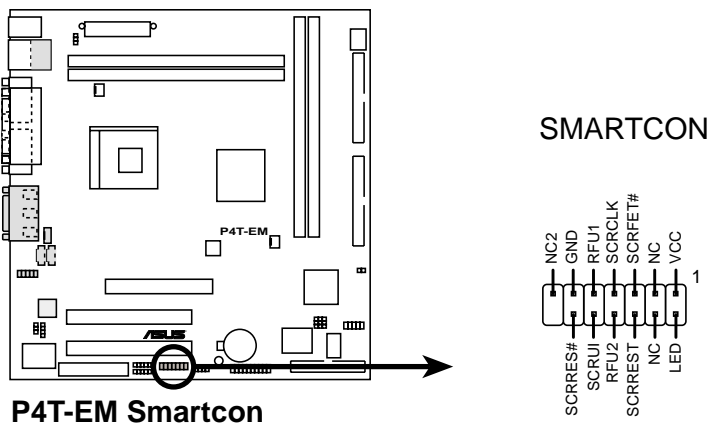

# 3. HARDWARE SETUP

The following diagram is for items 21–27:

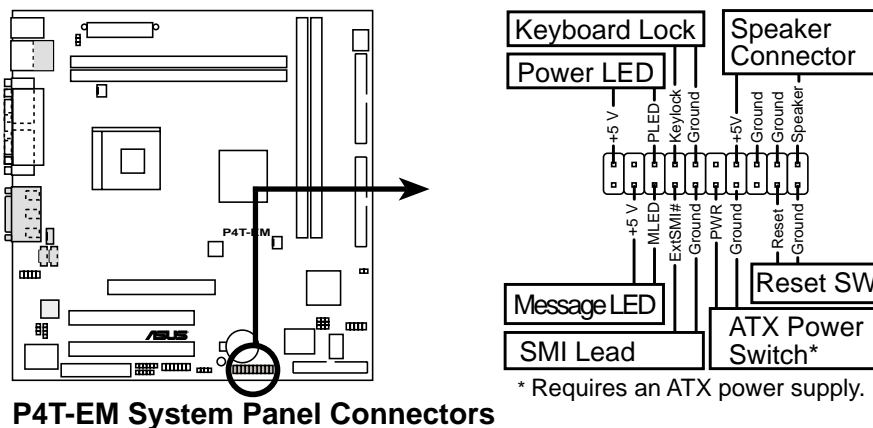

### 21) System Power LED Lead (3-1 pin PLED)

This 3-1 pin connector connects the system power LED, which lights when the system is powered on and blinks when it is in sleep mode.

### 22) Keyboard Lock Switch Lead (2-pin KEYLOCK)

This 2-pin connector connects to the case-mounted key switch to allow keyboard locking.

### 23) System Warning Speaker Connector (4-pin SPEAKER)

This 4-pin connector connects to the case-mounted speaker. Two sources (LINE\_OUT and SPEAKER) will allow you to hear system beeps and warnings. Only SPEAKER will allow you to hear system beeps before the integrated audio has been properly initialized.

### 24) System Message LED Lead (2-pin MLED)

This indicates whether a message has been received from a fax/modem. The LED will remain lit when there is no signal and blink when there is data received. This function requires an ACPI OS and driver support.

### 25) System Management Interrupt Lead (2-pin SMI)

This allows the user to manually place the system into a suspend mode or “Green” mode, where system activity is decreased to save electricity and expand the life of certain components when the system is not in use. This 2-pin connector connects to the case-mounted suspend switch.

### 26) ATX Power Switch Lead (2-pin PWRBTN)

The system power is controlled by a momentary switch connected to this lead. Pressing the button once will switch the system between ON and SOFT OFF. Pushing the switch while in the ON mode for more than 4 seconds will turn the system off. The system power LED shows the status of the system’s power.

### 27) Reset Switch Lead (2-pin RESET)

This 2-pin connector connects to the case-mounted reset switch for rebooting your computer without having to turn off your power switch. This is a preferred method of rebooting to prolong the life of the system’s power supply.



# 3. HARDWARE SETUP

---

## 3.9 Starting Up the First Time

1. After all connections are made, close the system case cover.
2. Be sure that all switches are off (in some systems, marked with ○), and the power input voltage is set to comply with the standard used in your country (220V-240V or 110-120V).
3. Connect the power supply cord into the power supply located on the back of your system case according to your system user's manual.
4. Connect the power cord into a power outlet that is equipped with a surge protector.
5. You may then turn on your devices in the following order:
  - a. Your monitor
  - b. External SCSI devices (starting with the last device on the chain)
  - c. Your system power. For ATX power supplies, you need to switch on the power supply as well as press the ATX power switch on the front of the case.
6. The power LED on the front panel of the system case will light. For ATX power supplies, the system LED will light when the ATX power switch is pressed. The LED on the monitor may light up or switch between orange and green after the system's if it complies with "green" standards or if it has a power standby feature. The system will then run power-on tests. While the tests are running, the BIOS will alarm beeps or additional messages will appear on the screen. If you do not see anything within 30 seconds from the time you turn on the power, the system may have failed a power-on test. Recheck your jumper settings and connections or call your retailer for assistance.

### Award BIOS Beep Codes

Beep	Meaning
One short beep when displaying logo	No error during POST
Long beeps in an endless loop	No DRAM installed or detected
One long beep followed by three short beeps	Video card not found or video card memory bad
High frequency beeps when system is working	CPU overheated System running at a lower frequency

## 3. HARDWARE SETUP

---

7. During power-on, hold down <Delete> to enter BIOS setup. Follow the instructions in **4. BIOS SETUP**.

- \* **Powering Off your computer:** You must first exit or shut down your operating system before switching off the power switch. For ATX power supplies, you can press the ATX power switch after exiting or shutting down your operating system. If you use Windows 9X, click the **Start** button, click **Shut Down**, and then click **Shut down the computer?** The power supply should turn off after Windows shuts down.

**NOTE:** The message “You can now safely turn off your computer” will not appear when shutting down with ATX power supplies.

# 4. BIOS SETUP

## 4.1 Managing and Updating Your BIOS

### 4.1.1 Upon First Use of the Computer System

It is recommended that you save a copy of the original motherboard BIOS along with a Flash Memory Writer utility (AFLASH.EXE) to a bootable floppy disk in case you need to reinstall the BIOS later. **AFLASH.EXE** is a Flash Memory Writer utility that updates the BIOS by uploading a new BIOS file to the programmable flash ROM on the motherboard. This file works only in DOS mode. To determine the BIOS version of your motherboard, check the last four numbers of the code displayed on the upper left-hand corner of your screen during bootup. Larger numbers represent a newer BIOS file.

1. Type **FORMAT A:/S** at the DOS prompt to create a bootable system floppy disk. **DO NOT** copy AUTOEXEC.BAT & CONFIG.SYS to the disk.
2. Type **COPY D:\AFLASH\AFLASH.EXE A:\** (assuming D is your CD-ROM drive) to copy AFLASH.EXE to the just created boot disk.

**NOTE:** AFLASH works only in DOS mode. It will not work with DOS prompt in Windows and will not work with certain memory drivers that may be loaded when you boot from your hard drive. It is recommended that you reboot using a floppy.

3. Reboot your computer from the floppy disk. **NOTE:** BIOS setup must specify “Floppy” as the first item in the boot sequence.
4. In DOS mode, type **A:\AFLASH <Enter>** to run AFLASH.

```
ASUS ACPI BIOS
FLASH MEMORY WRITER V1.29
Copyright (C) 1994-99, ASUSTeK COMPUTER INC.

Flash Memory: Unknown M29C020 or SST 29C020 or Intel B28H20E

Current BIOS Version: ASUS XXX-XX ACPI BIOS Revision 100X
BIOS Model          : XXX-XX
BIOS Built Date     : 09/25/98

Choose one of the followings:

1. Save Current BIOS To File
2. Update BIOS Including Boot Block and ESCD

Enter choice: [1]

Press ESC To Exit
```

**IMPORTANT!** If “unknown” is displayed after **Flash Memory:**, the memory chip is either not programmable or is not supported by the ACPI BIOS and therefore, cannot be programmed by the Flash Memory Writer utility.

# 4. BIOS SETUP

5. Select **1. Save Current BIOS to File** from the Main menu and press <Enter>. The **Save Current BIOS To File** screen appears.

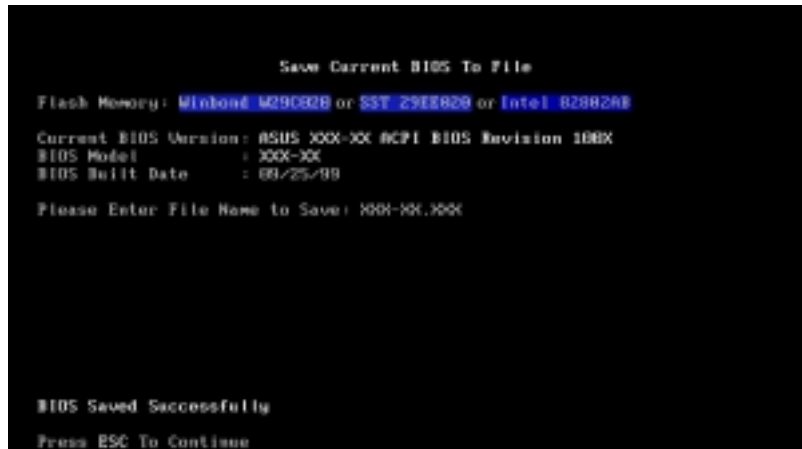

6. Type a filename and the path, for example, **A:\XXX-XX.XXX** and then press <Enter>.

## 4.1.2 Updating BIOS Procedures

**WARNING!** Only update your BIOS if you have problems with your motherboard and you know that the new BIOS revision will solve your problems. Careless updating can result in your motherboard having more problems!

1. Download an updated ASUS BIOS file from the Internet (WWW or FTP) (see ASUS CONTACT INFORMATION on page 3 for details) and save to the disk you created earlier.
2. Boot from the disk you created earlier.
3. At the “A:\” prompt, type **AFLASH** and then press <Enter>.
4. At the **Main Menu**, type **2** and then press <Enter>. The **Update BIOS Including Boot Block and ESCD** screen appears.
5. Type the filename of your new BIOS and the path, for example, **A:\XXX-XX.XXX**, and then press <Enter>.

**NOTE:** To cancel this operation, press <Enter>.

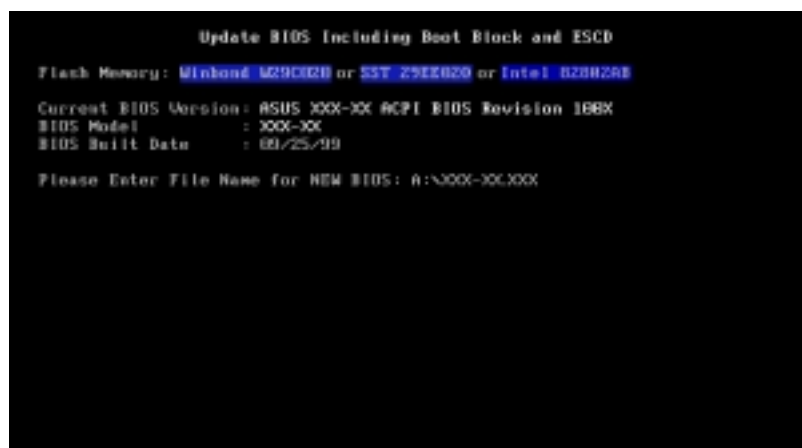

## 4. BIOS SETUP

- When prompted to confirm the BIOS update, press **Y** to start the update.

```
Update BIOS Including Boot Block and ESCD
Flash Memory: Winbond W29C02B or SST 29EE020 or Intel B20H2AE

BIOS Version
[CURRENT ] ASUS 1000-10X ACPI BIOS Revision 1000
[Test.ood] ASUS 1000-10X ACPI BIOS Revision 1000

BIOS Model
[CURRENT ] 1000-10X
[Test.ood] 1000-10X

Date of BIOS Built
[CURRENT ] 08/25/99
[XXXX.XXXX] 05/29/99

Check sum of 1001.010 is F25B.

Are you sure (Y/N) ? [Y]

Press ESC To Return to Main Menu
```

- The utility starts to program the new BIOS information into the flash ROM. The boot block will be updated automatically only when necessary. This will minimize the chance that a failed update will prevent your system from booting up. When the programming is finished, *Flashed Successfully* will be displayed.

```
Update BIOS Including Boot Block and ESCD
Flash Memory: Winbond W29C02B or SST 29EE020 or Intel B20H2AE

BIOS Version
[CURRENT ] ASUS 1000-10X ACPI BIOS Revision 1000
[Test.ood] ASUS 1000-10X ACPI BIOS Revision 1000

BIOS Model
[CURRENT ] 1000-10X
[Test.ood] 1000-10X

Date of BIOS Built
[CURRENT ] 08/25/99
[XXXX.XXXX] 05/29/99

Check sum of 1001.010 is F25B.

Are you sure (Y/N) ? [Y]
Block Erasing -- Done
Programming -- 3FFFF
Flashed Successfully

Press ESC To Continue
```

**NOTE:** When you see the message “Boot Block is different”, you may still press <Y> to update the BIOS. Yet if the update fails, your system will run a greater risk of boot failure depending on whether the boot block is damaged or not.

# 4. BIOS SETUP

8. Follow the onscreen instructions to continue.

```
ASUS ACPI BIOS
FLASH MEMORY WRITER V1.29
Copyright (C) 1994-99, ASUS/ASUS COMPUTER INC.

Flash Memory: Winbond W29C010 or SST 2916B20 or Intel B29H20E

Current BIOS Version: ASUS XXX-XX ACPI BIOS Revision 100X
BIOS Model           : XXX-XX
BIOS Build Date      : 05/29/99

Choose one of the followings:

1. Save Current BIOS To File
2. Update BIOS Including Boot Block and ESCD

Enter choice: [1]

You have flashed the EPROM. It is recommended that you turn off
the power, enter SETUP and Load Setup Defaults to have CMOS
updated with new BIOS when exits.

Press ESC To Exit
```

**WARNING!** If you encounter problems while updating the new BIOS, DO NOT turn off your system since this might prevent your system from booting up. Just repeat the process, and if the problem still persists, update the original BIOS file you saved to disk above. If the Flash Memory Writer utility was not able to successfully update a complete BIOS file, your system may not be able to boot up. If this happens, your system will need servicing.

# 4. BIOS SETUP

---

## 4.2 BIOS Setup Program

This motherboard supports a programmable EEPROM that can be updated using the provided utility as described in *4.1 Managing and Updating Your BIOS*.

The utility is used if you are installing a motherboard, reconfiguring your system, or prompted to “**Run Setup**”. This section describes how to configure your system using this utility.

Even if you are not prompted to use the Setup program, at some time in the future you may want to change the configuration of your computer. For example, you may want to enable the Security Password Feature or make changes to the power management settings. It will then be necessary to reconfigure your system using the BIOS Setup program so that the computer can recognize these changes and record them in the CMOS RAM of the EEPROM.

The EEPROM on the motherboard stores the Setup utility. When you start up the computer, the system provides you with the opportunity to run this program. This appears during the Power-On Self Test (POST). Press <Delete> to call up the Setup utility. If you are a little bit late in pressing the mentioned key, POST will continue with its test routines, thus preventing you from calling up Setup. If you still need to call Setup, restart the system by pressing <Ctrl> + <Alt> + <Delete>, or by pressing the Reset button on the system chassis. You can also restart by turning the system off and then back on again. But do so only if the first two methods fail.

The Setup program has been designed to make it as easy to use as possible. It is a menu-driven program, which means you can scroll through the various sub-menus and make your selections among the predetermined choices.

**To access the BIOS Setup program, press the <Delete> key after the computer has run through its POST.**

**NOTE:** Because the BIOS software is constantly being updated, the following BIOS screens and descriptions are for reference purposes only and may not reflect your BIOS screens exactly.

# 4. BIOS SETUP

## 4.2.1 BIOS Menu Bar

The top of the screen has a menu bar with the following selections:

- MAIN** Use this menu to make changes to the basic system configuration.
- ADVANCED** Use this menu to enable and make changes to the advanced features.
- POWER** Use this menu to configure and enable Power Management features.
- BOOT** Use this menu to configure the default system device used to locate and load the Operating System.
- EXIT** Use this menu to exit the current menu or specify how to exit the Setup program.

To access the menu bar items, press the right or left arrow key on the keyboard until the desired item is highlighted.

## 4.2.2 Legend Bar

At the bottom of the Setup screen you will notice a legend bar. The keys in the legend bar allow you to navigate through the various setup menus. The following table lists the keys found in the legend bar with their corresponding alternates and functions.

Navigation Key(s)	Function Description
<F1> or <Alt + H>	Displays the General Help screen from anywhere in the BIOS Setup
<Esc>	Jumps to the Exit menu or returns to the main menu from a sub-menu
← or → (keypad arrow)	Selects the menu item to the left or right
↑ or ↓ (keypad arrow)	Moves the highlight up or down between fields
- (minus key)	Scrolls backward through the values for the highlighted field
+ (plus key) or spacebar	Scrolls forward through the values for the highlighted field
<Enter>	Brings up a selection menu for the highlighted field
<Home> or <PgUp>	Moves the cursor to the first field
<End> or <PgDn>	Moves the cursor to the last field
<F5>	Resets the current screen to its Setup Defaults
<F10>	Saves changes and exits Setup



# 4. BIOS SETUP

---

## General Help

In addition to the Item Specific Help window, the BIOS setup program also provides a General Help screen. This screen can be called up from any menu by simply pressing <F1> or the <Alt> + <H> combination. The General Help screen lists the legend keys with their corresponding alternates and functions.

## Saving Changes and Exiting the Setup Program

See *4.7 Exit Menu* for detailed information on saving changes and exiting the setup program.

## Scroll Bar

When a scroll bar appears to the right of a help window, it indicates that there is more information to be displayed that will not fit in the window. Use <PgUp> and <PgDn> or the up and down arrow keys to scroll through the entire help document. Press <Home> to display the first page, press <End> to go to the last page. To exit the help window, press <Enter> or <Esc>.

## Sub-Menu

Note that a right pointer symbol (as shown in the left view) appears to the left of certain fields. This pointer indicates that a sub-menu can be launched from this field. A sub-menu contains additional options for a field parameter. To call up a sub-menu, simply move the highlight to the field and press <Enter>. The sub-menu will then immediately appear. Use the legend keys to enter values and move from field to field within a sub-menu just as you would within a menu. Use the <Esc> key to return to the main menu.

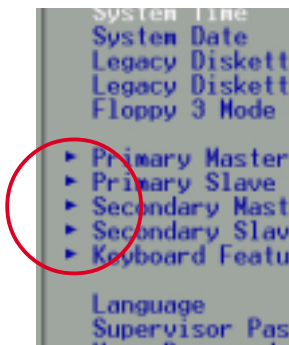

Take some time to familiarize yourself with each of the legend keys and their corresponding functions. Practice navigating through the various menus and sub-menus. If you accidentally make unwanted changes to any of the fields, use the set default hot key <F5>. While moving around through the Setup program, note that explanations appear in the Item Specific Help window located to the right of each menu. This window displays the help text for the currently highlighted field.

**NOTE:** The item heading in square brackets represents the default setting for that field.

# 4. BIOS SETUP

## 4.3 Main Menu

When the Setup program is accessed, the following screen appears:

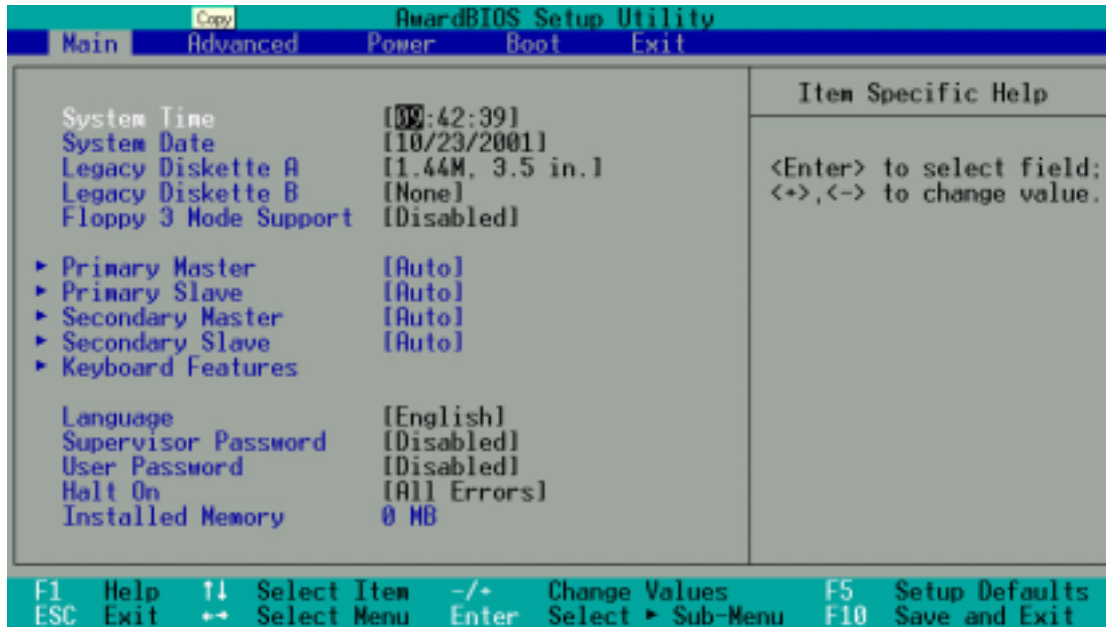

### System Time [XX:XX:XX]

Sets your system to the time that you specify (usually the current time). The format is hour, minute, second. Valid values for hour, minute and second are **Hour: (00 to 23)**, **Minute: (00 to 59)**, **Second: (00 to 59)**. Use the <Tab> or <Shift> + <Tab> keys to move between the hour, minute, and second fields.

### System Date [XX/XX/XXXX]

Sets your system to the date that you specify (usually the current date). The format is month, day, year. Valid values for month, day, and year are **Month: (1 to 12)**, **Day: (1 to 31)**, **Year: (100 year range)**. Use the <Tab> or <Shift> + <Tab> keys to move between the month, day, and year fields.

### Legacy Diskette A [1.44M, 3.5 in.], Legacy Diskette B [None]

Sets the type of floppy drives installed. Configuration options: [None] [360K, 5.25 in.] [1.2M , 5.25 in.] [720K , 3.5 in.] [1.44M, 3.5 in.] [2.88M, 3.5 in.]

### Floppy 3 Mode Support [Disabled]

This is required to support older Japanese floppy drives. Floppy 3 Mode support will allow reading and writing of 1.2MB (as opposed to 1.44MB) on a 3.5-inch diskette. Configuration options: [Disabled] [Drive A] [Drive B] [Both]

# 4. BIOS SETUP

## 4.3.1 Primary & Secondary Master/Slave

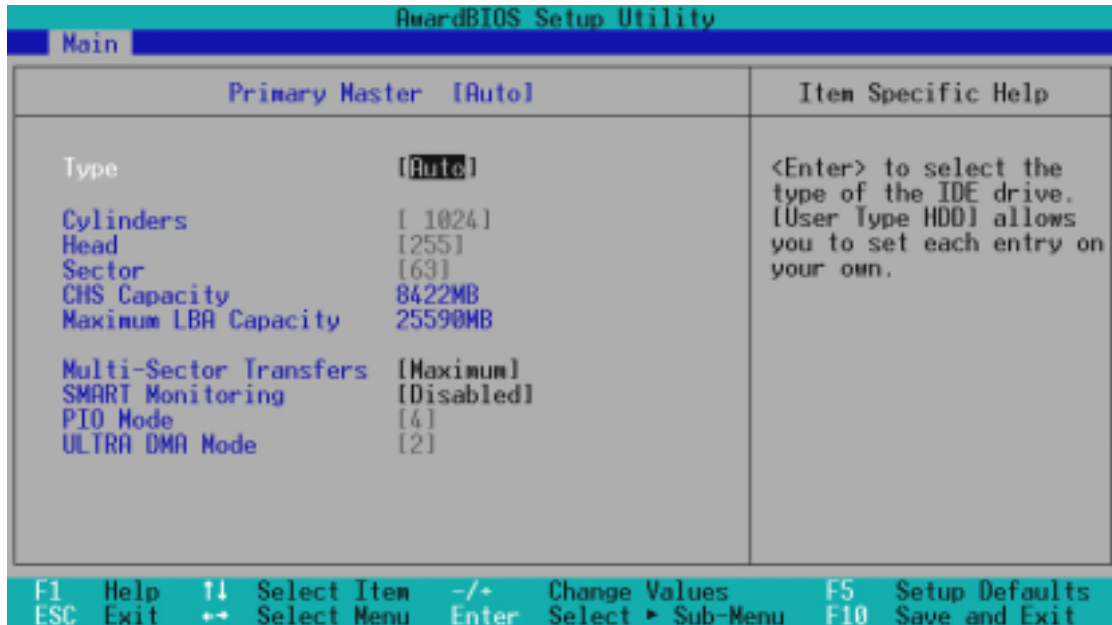

**NOTE:** Before attempting to configure a hard disk drive, make sure you have the configuration information supplied by the manufacturer of the drive. Incorrect settings may cause your system to not recognize the installed hard disk. To allow the BIOS to detect the drive type automatically, select [Auto].

### Type [Auto]

Select [Auto] to automatically detect an IDE hard disk drive. If automatic detection is successful, the correct values will be filled in for the remaining fields on this sub-menu. If automatic detection fails, your hard disk drive may be too old or too new. You can try updating your BIOS or enter the IDE hard disk drive parameters manually.

**NOTE:** After the IDE hard disk drive information has been entered into BIOS, new IDE hard disk drives must be partitioned (such as with FDISK) and then formatted before data can be read from and write on. Primary IDE hard disk drives must have its partition set to *active* (also possible with FDISK).

Other options for the **Type** field are:

-----  
**[None]** - to disable IDE devices

# 4. BIOS SETUP

**IMPORTANT:** If your hard disk was already formatted on an older previous system, incorrect parameters may be detected. You will need to enter the correct parameters manually or use low-level format if you do not need the data stored on the hard disk. If the parameters listed differ from the ones used when the disk was formatted, the disk will not be readable. If the auto-detected parameters do not match the ones that should be used for your disk, you should enter the correct ones manually by setting [User Type HDD].

## [User Type HDD]

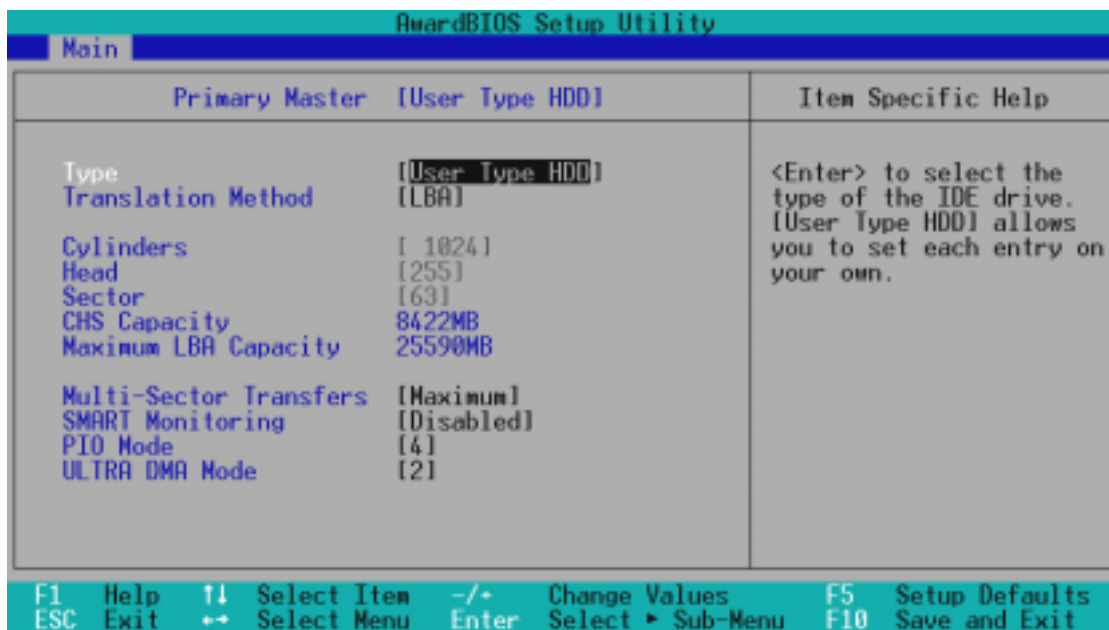

Manually enter the number of cylinders, heads and sectors per track for your drive. Refer to your drive documentation or look on the drive for this information. If no drive is installed or if you are removing a drive and not replacing it, select [None].

### Translation Method [LBA]

Select the hard disk drive type in this field. When Logical Block Addressing is enabled, 28-bit addressing of the hard drive is used without regard for cylinders, heads, or sectors. Note that LBA Mode is necessary for drives with greater than 504MB in storage capacity. Configuration options: [LBA] [LARGE] [Normal] [Match Partition Table] [Manual]

### Cylinders

This field configures the number of cylinders. Refer to your drive documentation to determine the correct value to enter into this field. **NOTE:** To make changes to this field, the **Type** field must be set to [User Type HDD] and the **Translation Method** field must be set to [Manual].

# 4. BIOS SETUP

---

## Head

This field configures the number of read/write heads. Refer to your drive documentation to determine the correct value to enter into this field. **NOTE:** To make changes to this field, the **Type** field must be set to [User Type HDD] and the **Translation Method** field must be set to [Manual].

## Sector

This field configures the number of sectors per track. Refer to your drive documentation to determine the correct value to enter into this field. **NOTE:** To make changes to this field, the **Type** field must be set to [User Type HDD] and the **Translation Method** field must be set to [Manual].

## CHS Capacity

This field shows the drive's maximum CHS capacity calculated automatically by the BIOS from the drive information you entered.

## Maximum LBA Capacity

This field shows the drive's maximum LBA capacity calculated automatically by the BIOS from the drive information you entered.

## Multi-Sector Transfers [Maximum]

This option automatically sets the number of sectors per block to the highest number supported by the drive. This field can also be configured manually. Note that when this field is automatically configured, the set value may not always be the fastest value for the drive. Refer to the documentation that came with your hard drive to determine the optimal value and set it manually. **NOTE:** To make changes to this field, the **Type** field must be set to [User Type HDD]. Configuration options: [Disabled] [2 Sectors] [4 Sectors] [8 Sectors] [16 Sectors] [32 Sectors] [Maximum]

## SMART Monitoring [Disabled]

This allows the enabling or disabling of the S.M.A.R.T. (Self-Monitoring, Analysis and Reporting Technology) system which utilizes internal hard disk drive monitoring technology. This feature is normally disabled because system resources used in this feature may decrease system performance. Configuration options: [Disabled] [Enabled]

## PIO Mode [4]

This option lets you set a PIO (Programmed Input/Output) mode for the IDE device. Modes 0 through 4 provide successively increased performance. Configuration options: [0] [1] [2] [3] [4]

## Ultra DMA Mode [Disabled]

Ultra DMA capability allows improved transfer speeds and data integrity for compatible IDE devices. Set to [Disabled] to suppress Ultra DMA capability. **NOTE:** To make changes to this field, the **Type** field must be set to [User Type HDD]. Configuration options: [0] [1] [2] [3] [4] [Disabled]

# 4. BIOS SETUP

Other options for “Type:” are:

[CD-ROM] - for IDE CD-ROM drives

[LS-120] - for LS-120 compatible floppy disk drives

[ZIP] - for ZIP compatible disk drives

[MO] - for IDE magneto optical disk drives

[Other ATAPI Device] - for IDE devices not listed here

After using the legend keys to make your selections on this sub-menu, press the <Esc> key to exit back to the Main menu. When the Main menu appears, you will notice that the drive size appear in the field for the hard disk drive that you just configured.

-----

## 4.3.2 Keyboard Features

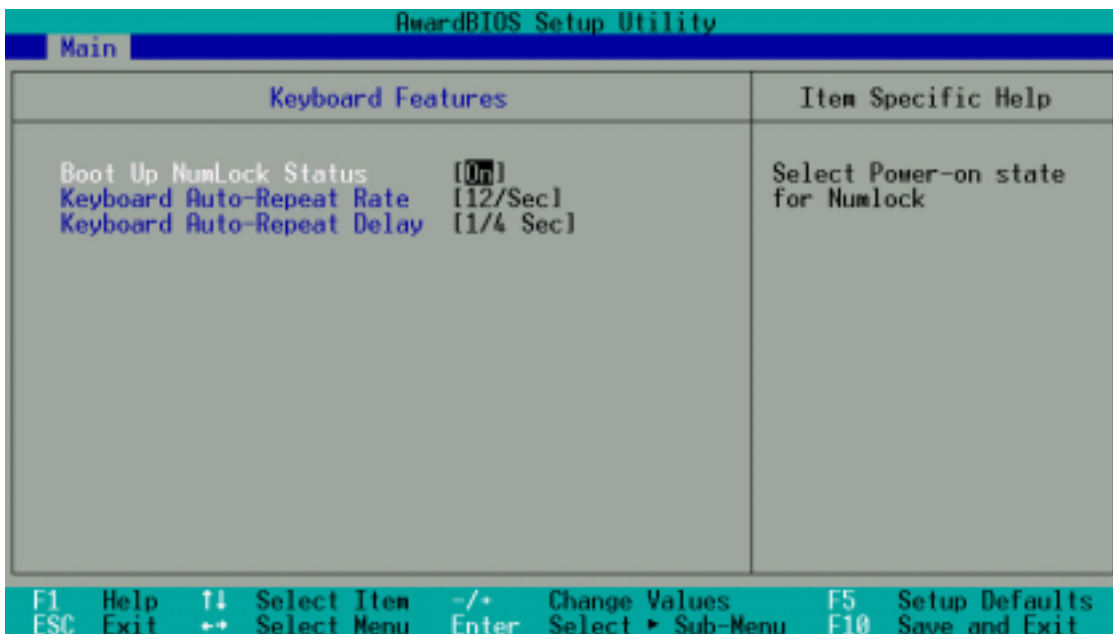

### Boot Up NumLock Status [On]

This field enables users to activate the Number Lock function upon system boot. Configuration options: [Off] [On]

### Keyboard Auto-Repeat Rate [12/Sec]

This controls the speed at which the system registers repeated keystrokes. Options range from 6 to 30 characters per second. Configuration options: [6/Sec] [8/Sec] [10/Sec] [12/Sec] [15/Sec] [20/Sec] [24/Sec] [30/Sec]

### Keyboard Auto-Repeat Delay [1/4 Sec]

This field sets the time interval for displaying the first and second characters. Configuration options: [1/4 Sec] [1/2 Sec] [3/4 Sec] [1 Sec]

-----

# 4. BIOS SETUP

## Language [English]

This allows selection of the BIOS' displayed language. Currently only English is available.

## Supervisor Password [Disabled] / User Password [Disabled]

These fields allow you to set the passwords. To set the password, highlight the appropriate field and press <Enter>. Type in a password and press <Enter>. You can type up to eight alphanumeric characters. Symbols and other keys are ignored. To confirm the password, type the password again and press the <Enter>. The password is now set to [Enabled]. This password allows full access to the BIOS Setup menus. To clear the password, highlight this field and press <Enter>. The same dialog box as above will appear. Press <Enter> and the password will be set to [Disabled].

### A Note about Passwords

The BIOS Setup program allows you to specify passwords in the Main menu. The passwords control access to the BIOS during system startup. The passwords are not case sensitive. In other words, it makes no difference whether you enter a password using upper or lowercase letters. The BIOS Setup program allows you to specify two separate passwords: a Supervisor password and a User password. When disabled, anyone may access all BIOS Setup program functions. When enabled, the Supervisor password is required for entering the BIOS Setup program and having full access to all configuration fields.

### Forgot the Password?

If you forgot the password, you can clear the password by erasing the CMOS Real Time Clock (RTC) RAM. The RAM data containing the password information is powered by the onboard button cell battery. To erase the RTC RAM: (1) Unplug your compute; (2) Place a jumper cap on the two pins CLCMOS, (above RN40); (3) Uncap the jumper; (4) Turn ON your computer; (5) Hold down <Delete> during bootup and enter BIOS setup to re-enter user preferences.

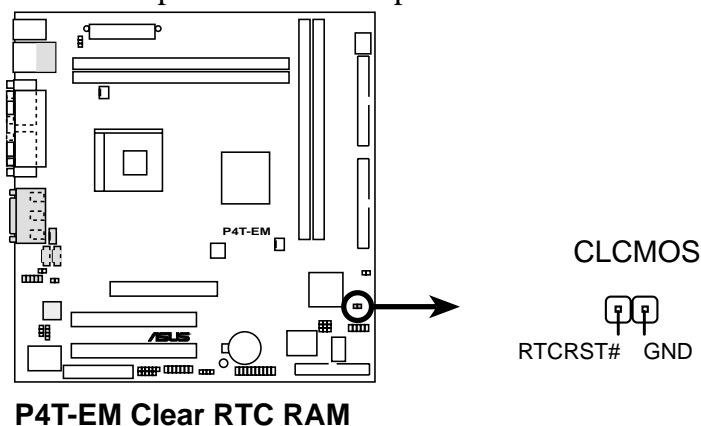

## Halt On [All Errors]

This field determines which types of errors will cause the system to halt. Configuration options: [All Errors] [No Error] [All but Keyboard] [All but Disk] [All but Disk/Keyboard]

## Installed Memory [XXX MB]

This display-only field displays the amount of conventional memory detected by the system during bootup. You do not need to make changes to this field.



# 4. BIOS SETUP

## 4.4 Advanced Menu

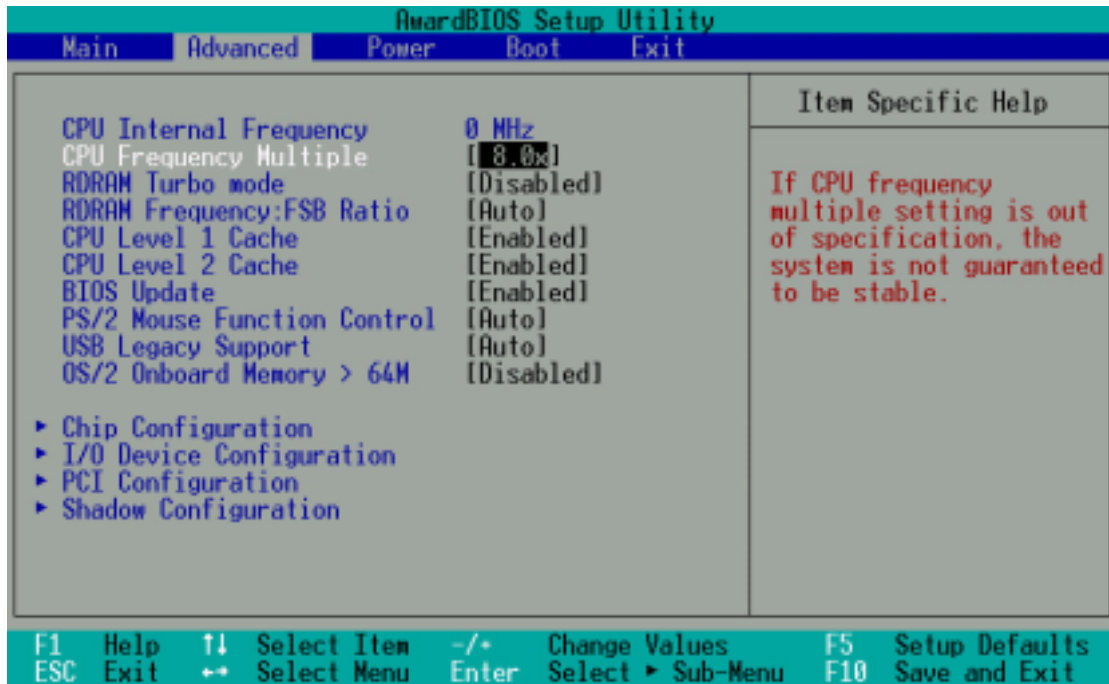

### CPU Internal Frequency

This field displays the internal frequency of your CPU. Changes to the CPU Frequency Multiple field are reflected here after rebooting the PC and re-entering BIOS. Note selecting a frequency higher than the CPU manufacturer recommends may cause the system to hang or crash.

### CPU Frequency Multiple [8.0x]

This field automatically sets the frequency multiple between the CPU's *internal* frequency (CPU speed) and the *external* frequency. Increasing the multiple increases the CPU internal frequency. Reboot the computer for changes to take effect. Configuration options: [8x] [10x] [11x]...[24x]

### RDRAM Turbo Mode [Disabled]

This feature enables the RDRAM Turbo feature. Select to improve system performance. BIOS will optimize the RDRAM timing register. Configuration options: [Disabled] [Enabled]

### RDRAM Frequency:FSB Ratio (MHz) [Auto]

This feature tells the clock generator which frequency to send to the RDRAM. The default setting [Auto] makes the system detect and set the ratio according to the type of RDRAM module. The [Auto] default balances performance with stability. Alternatively, with PC600 RDRAM, select [3x], and with PC800 RDRAM, select [4x]. If overclocking the CPU, select [3x] to maintain stability. Configuration options: [Auto] [3x] [4x]



## 4. BIOS SETUP

---

### **CPU Level 1 Cache, CPU Level 2 Cache [Enabled]**

These fields allow you to choose from the default of [Enabled] or choose [Disabled] to turn on or off the CPU's Level 1 and Level 2 built-in cache. Configuration options: [Disabled] [Enabled]

### **BIOS Update [Enabled]**

This functions as an update loader integrated into the BIOS to supply the processor with the required data. In the default position of [Enabled], the BIOS will load the update on all processors during system bootup. Configuration options: [Disabled] [Enabled]

### **PS/2 Mouse Function Control [Auto]**

The default of [Auto] allows the system to detect a PS/2 mouse on startup. If detected, IRQ12 will be used for the PS/2 mouse. IRQ12 will be reserved for expansion cards only if a PS/2 mouse is not detected. [Enabled] will always reserve IRQ12, whether on startup a PS/2 mouse is detected or not. Configuration options: [Enabled] [Auto]

### **USB Legacy Support [Auto]**

This motherboard supports Universal Serial Bus (USB) devices. The default of [Auto] allows the system to detect a USB device on startup. If detected, USB controller legacy mode will be enabled. If not detected, USB controller legacy mode will be disabled. When this field is set to [Disabled], USB controller legacy mode is disabled no matter whether you are using a USB device or not. Configuration options: [Disabled] [Enabled] [Auto]

### **OS/2 Onboard Memory > 64M [Disabled]**

When using OS/2 operating systems with installed DRAM of greater than 64MB, you need to set this option to [Enabled]; otherwise, leave this on [Disabled]. Configuration options: [Disabled] [Enabled]

# 4. BIOS SETUP

## Notes for JumperFree Mode

### CPU Upgrade/Reinstallation

To ensure that your system can enter BIOS setup after the processor has been changed or reinstalled, your system will start up running at a bus speed of 100MHz and a fail-safe CPU internal frequency (8x100MHz). It will then automatically take you to the Advanced menu with a popup menu of all the officially possible CPU internal frequencies.

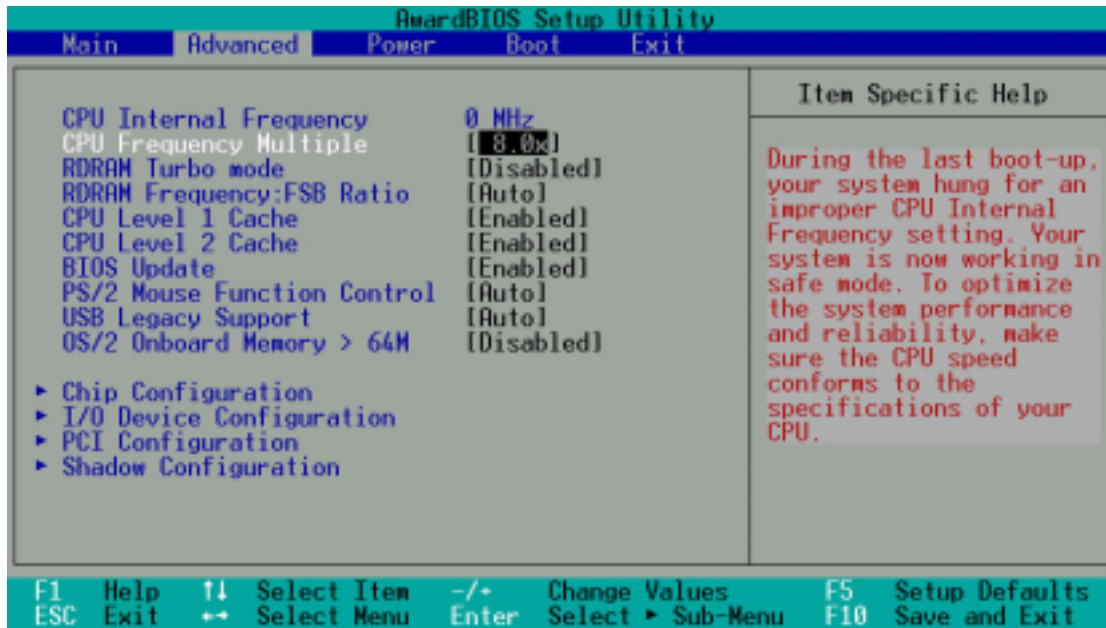

# 4. BIOS SETUP

## 4.4.1 Chip Configuration

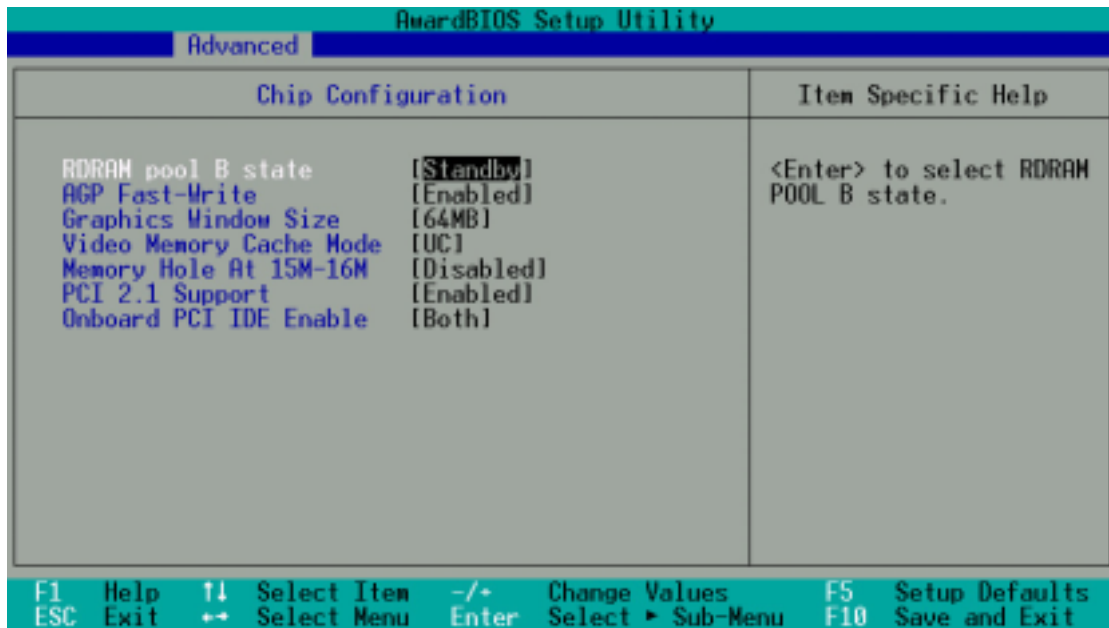

### RDRAM Pool B State [Standby]

This sets the operating state of the RDRAM devices in Pool B. Selecting [Nap] allows the RDRAM in Pool B to enter power-saving mode. [Standby] allows the RDRAM in Pool B to return to the working state quickly. Configuration options: [Standby] [Nap]

### AGP Fast-Write [Enabled]

This controls the AGP fast-write function. Configuration options: [Enabled] [Disabled]

### Graphics Window Size [64MB]

This feature allows you to select the size of mapped memory for AGP graphic data. Configuration options: [4MB] [8MB] [16MB] [32MB] [64MB] [128MB] [256MB]

### Video Memory Cache Mode [UC]

USWC (uncacheable, speculative write combining) is a new cache technology for the video memory of the processor. It can greatly improve the display speed by caching the display data. You must set this to UC (uncacheable) if your display card cannot support this feature; otherwise your system may not boot. Configuration options: [UC] [USWC]

### Memory Hole At 15M-16M [Disabled]

This field allows you to reserve an address space for ISA expansion cards that require it. Setting the address space to a particular setting will make that memory space unavailable to the system. Expansion cards can only access memory up to 16MB. Configuration options: [Disabled] [Enabled]

# 4. BIOS SETUP

---

## **PCI 2.1 Support [Enabled]**

This function allows you to enable or disable PCI 2.1 features including passive release and delayed transaction. Configuration options: [Disabled] [Enabled]

## **Onboard PCI IDE Enable [Both]**

You can select to enable the primary IDE channel, secondary IDE channel, both, or disable both channels. Configuration options: [Both] [Primary] [Secondary] [Disabled]

# 4. BIOS SETUP

## 4.4.2 I/O Device Configuration

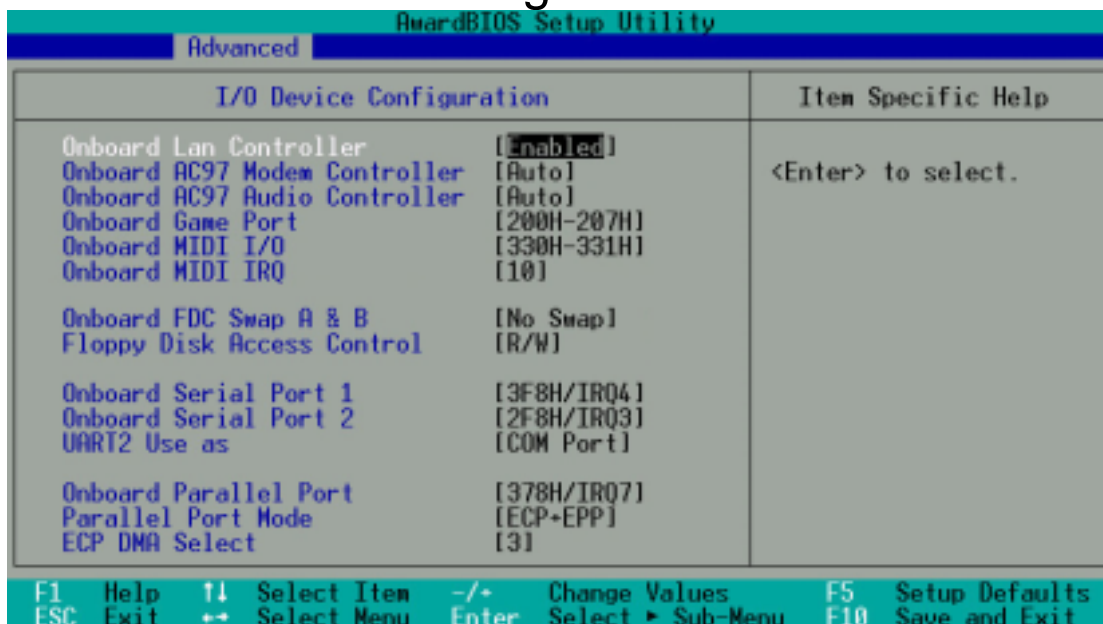

### Onboard LAN Controller [Enabled]

The motherboard offers an AC97 Modem Controller chip. BIOS automatically activates the Modem Controller if it is available. Configuration options; [Enabled] [Disabled]

### Onboard AC97 Modem Controller [Auto]

The motherboard offers an AC97 Modem Controller chip. BIOS automatically activates the Modem Controller if it is available. Configuration options; [Auto] [Disabled]

### Onboard AC97 Audio Controller [Auto]

The motherboard offers an AC97 Audio Controller chip. BIOS automatically activates the Audio Controller if it is available. Configuration options; [Auto] [Disabled]

### Onboard Game Port [200H-207H]

This field sets the I/O address to the game port. Configuration options; [200H-207H] [208H-20FH]

### Onboard MIDI I/O [330H-331H]

This field sets the I/O address and IRQ for MIDI. Configuration options; [330H-331H] [300H-301H]

### Onboard MIDI IRQ [10]

This field indicates the onboard IRQ assignment for MIDI. Configuration options; [3 ,4, 5, 7, 9, 10, 11, 12, 14, 15]

# 4. BIOS SETUP

---

## **Onboard FDC Swap A+B [No Swap]**

This option selects drive letter assignments. Configuration options; [No Swap] [Swap AB]

## **Floppy Disk Access Control [R/W]**

When set to [Read Only], this field protects files from being copied to floppy disks by allowing reads from the floppy disk drive but not writes. The setup default [R/W] allows both reads and writes. Configuration options: [R/W] [Read Only]

## **Onboard Serial Port 1 [3F8H/IRQ4], Onboard Serial Port 2 [2F8H/IRQ3]**

These fields set the addresses for the onboard serial connectors. Serial Port 1 and Serial Port 2 must have different addresses. Configuration options: [3F8H/IRQ4] [2F8H/IRQ3] [3E8H/IRQ4] [2E8H/IRQ10] [Disabled]

## **UART2 Use as [Com Port]**

This field is defaulted to activate the extra onboard com port and sets the second serial UART to support the infrared module connector on the motherboard. If your system already has a second serial port connected to the onboard COM2 connector, it will no longer work if you enable the infrared feature. See **Infrared Module Connector** in *3.8 External Connectors*. Configuration options: [Com Port] [IR] [Smart Card Reader]

## **Onboard Parallel Port [378H/IRQ7]**

This field sets the address of the onboard parallel port connector. If you disable this feature, **Parallel Port Mode** and **ECP DMA Select** configurations will not be available. Configuration options: [Disabled] [378H/IRQ7] [278H/IRQ5]

## **Parallel Port Mode [ECP+EPP]**

This field allows you to set the operation mode of the parallel port. [Normal] allows normal-speed operation but in one direction only; [EPP] allows bidirectional parallel port operation; [ECP] allows the parallel port to operate in bidirectional DMA mode; [ECP+EPP] allows normal speed operation in a two-way mode. Configuration options: [Normal] [EPP] [ECP] [ECP+EPP]

## **ECP DMA Select [3]**

This field allows you to configure the parallel port DMA channel for the selected **ECP** mode. This selection is available only if you select [ECP] or [ECP+EPP] in **Parallel Port Mode** above. Configuration options: [1] [3]

# 4. BIOS SETUP

## 4.4.3 PCI Configuration

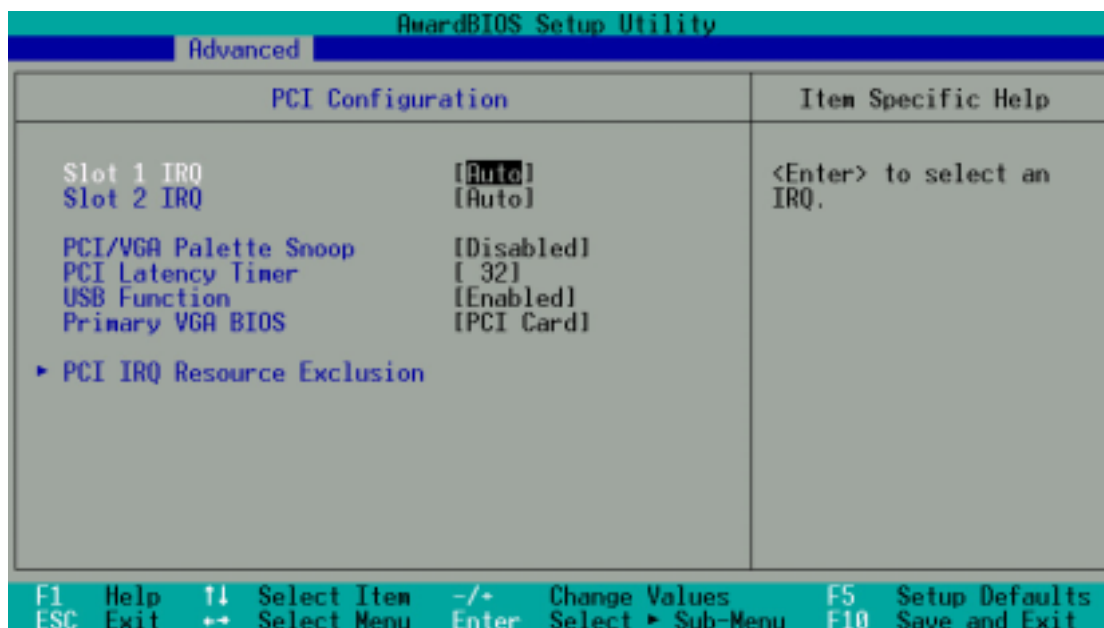

### Slot 1 IRQ, Slot 2 IRQ [Auto]

These fields set how IRQ use is determined for each PCI slot. The default setting for each field is [Auto], which uses auto-routing to assign IRQs. Configuration options: [Auto] [NA] [3] [4] [5] [7] [9] [10] [11] [12] [14] [15]

### PCI/VGA Palette Snoop [Disabled]

Some nonstandard VGA cards, such as graphics accelerators or MPEG video cards, may not show colors properly. The setting [Enabled] should correct this problem. Otherwise, leave this on the default setting of [Disabled]. Configuration options: [Disabled] [Enabled]

### PCI Latency Timer [32]

Leave on default setting for best performance vs. stability. Configuration options: [Disabled] [Enabled]

### USB Function [Enabled]

This motherboard supports Universal Serial Bus (USB) devices. Set to [Enabled] if you want to use USB devices. Configuration options: [Disabled] [Enabled]

### Primary VGA BIOS [PCI Card]

If your computer has both PCI and AGP VGA cards, this field allows you to select which of the cards will act as your primary graphics card. [AGP Card] uses the AGP card as your primary card. The default, [PCI Card], allows your PCI graphics card to take precedence when detected. Configuration options: [PCI Card] [AGP Card]

# 4. BIOS SETUP

## PCI/PNP IRQ Resource Exclusion

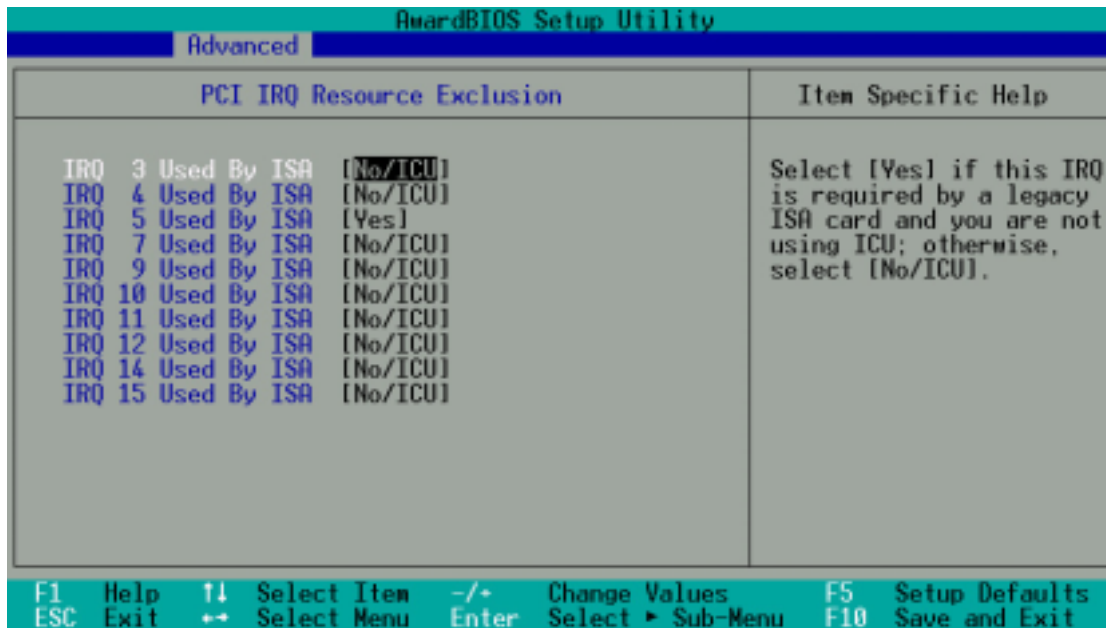

### IRQ XX Reserved for Legacy Device [No/ICU]

These fields indicate whether or not the displayed IRQ for each field is being used by an onboard legacy (non-PnP) device. The default value indicates either that the displayed IRQ is not used or that the ISA Configuration Utility (ICU) is being used to determine if a legacy device is using that IRQ. If the IRQ is required by a legacy device, then reserve the IRQ by selecting [Yes]. Otherwise, select [No/ICU] to release the IRQ to OS. Configuration options: [No/ICU] [Yes]



# 4. BIOS SETUP

## 4.4.4 Shadow Configuration

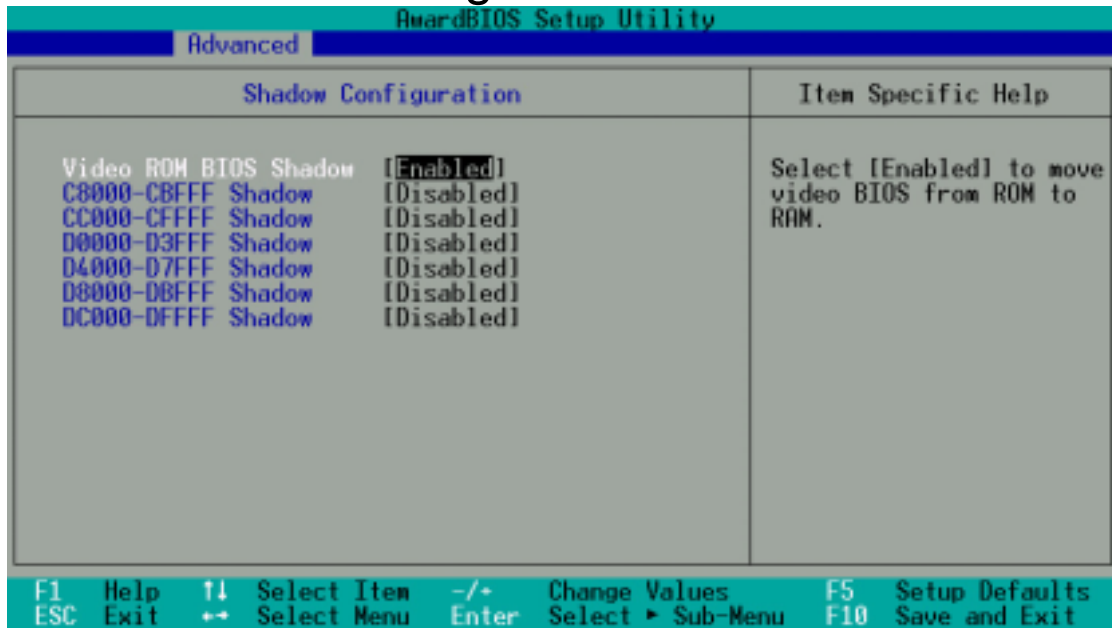

### Video ROM BIOS Shadow [Enabled]

This field allows you to change the video BIOS location from ROM to RAM. Relocating to RAM enhances system performance, as information access is faster than the ROM. Configuration options: [Disabled] [Enabled]

### C8000-DFFFF Shadow [Disabled]

These fields are used for shadowing other expansion card ROMs. If you install other expansion cards with ROMs on them, you will need to know which addresses the ROMs use to shadow them specifically. Shadowing a ROM reduces the memory available between 640K and 1024K by the amount used for this purpose. Configuration options: [Disabled] [Enabled]

# 4. BIOS SETUP

## 4.5 Power Menu

The Power menu allows you to reduce power consumption. This feature turns off the video display and shuts down the hard disk after a period of inactivity.

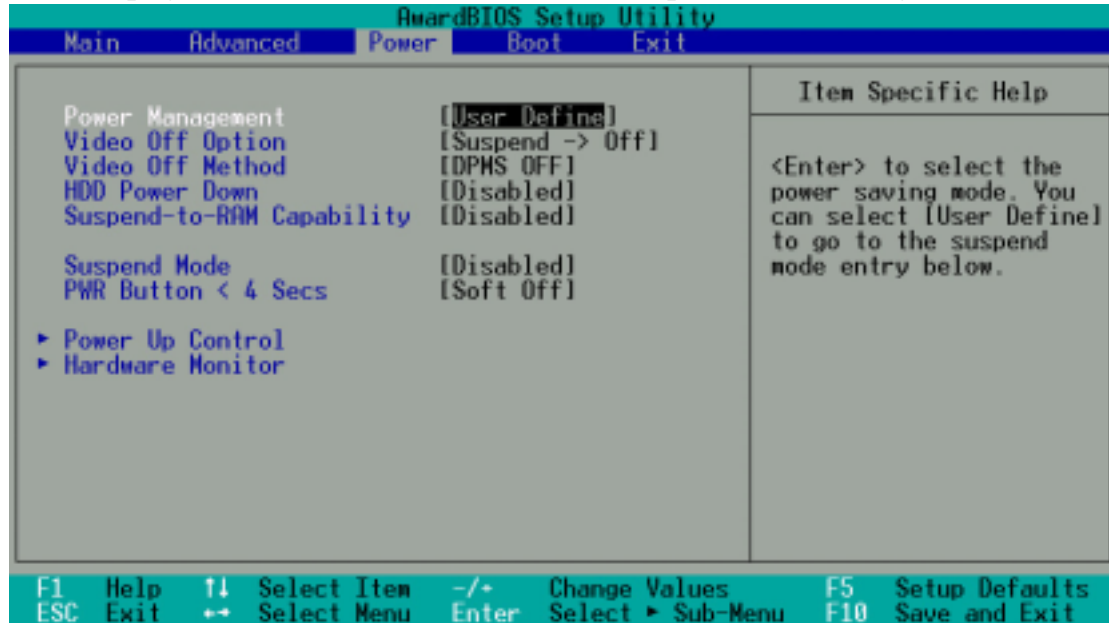

### Power Management [User Define]

This option must be enabled to use any of the automatic power saving features. If this menu item is set to [Disabled], power management features will not function regardless of other field settings on this menu. The [User Define] option allows you to make your own selections in the Power menu. When set to [Max Saving], system power will be conserved to its greatest amount. The **Suspend Mode** field will then be set to predefined value that ensures maximum power savings.

This field acts as the master control for the power management modes. [Max Saving] puts the system into power saving mode after a brief period of system inactivity; [Min Saving] is almost the same as [Max Saving] except that the system inactivity period is longer; [Disabled] disables the power saving features; [User Define] allows you to set power saving options according to your preference. Configuration options: [User Define] [Disabled] [Min Saving] [Max Saving]

**IMPORTANT:** Advanced Power Management (APM) should be installed to keep the system time updated when the computer enters suspend mode activated by the BIOS Power Management. For DOS environments, you need to add the statement, `DEVICE=C:\DOS\POWER.EXE`, to your `CONFIG.SYS` file. For Windows 3.x and Windows 95, you need to install Windows with the APM feature. For Windows 98 and later, APM is automatically installed. A battery and power cord icon labeled “Power Management” will appear in the “Control Panel.” Choose “Advanced” in the Power Management Properties dialog box.

## 4. BIOS SETUP

---

### **Video Off Option [Suspend -> Off ]**

This field determines when to activate the video off feature for monitor power management. Configuration options: [Always On] [Suspend -> Off]

### **Video Off Method [DPMS OFF]**

This field defines the video off features. The DPMS (Display Power Management System) feature allows the BIOS to control the video display card if it supports the DPMS feature. [Blank Screen] only blanks the screen (use this for monitors without power management or “green” features. If set up in your system, your screen saver will not display with [Blank Screen] selected). [V/H SYNC+Blank] blanks the screen and turns off vertical and horizontal scanning. Configuration options: [Blank Screen] [V/H SYNC+Blank] [DPMS Standby] [DPMS Suspend] [DPMS OFF] [DPMS Reduce ON]

### **HDD Power Down [Disabled]**

Shuts down any IDE hard disk drives in the system after a period of inactivity as set in this user-configurable field. This feature does not affect SCSI hard drives. Configuration options: [Disabled] [1 Min] [2 Min] [3 Min]...[15 Min]

### **Suspend-to-RAM Capability [Disabled]**

This field lets you to enable or disable the Suspend-to-RAM (STR) feature allowing the system to go into suspend mode after the specified time in the Suspend Mode parameter. Configuration options: [Disabled] [enabled]

### **Suspend Mode [Disabled]**

Sets the time period before the system goes into suspend mode. Configuration options: [Disabled] [1-2 Min] [2-3 Min]...[1 Hour]

### **PWR Button < 4 Secs [Soft Off]**

When set to [Soft off], the ATX switch can be used as a normal system power-off button when pressed for less than 4 seconds. [Suspend] allows the button to have a dual function where pressing less than 4 seconds will place the system in sleep mode. Regardless of the setting, holding the ATX switch for more than 4 seconds will power off the system. Configuration options: [Soft off] [Suspend]

# 4. BIOS SETUP

## 4.5.1 Power Up Control

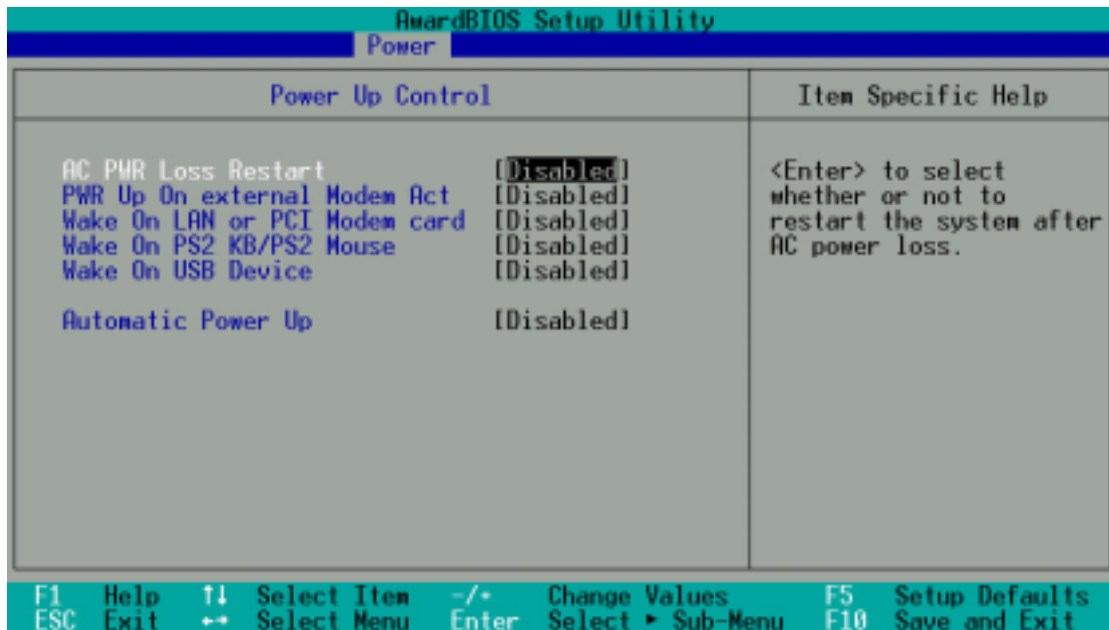

### AC PWR Loss Restart [Disabled]

This allows you to set whether you want your system to reboot after the power has been interrupted. [Disabled] leaves your system off and [Enabled] reboots your system. [Previous State] sets your system back to the state it is before the power interruption. Configuration options: [Disabled] [Enabled] [Previous State]

### PWR Up On external Modem Act [Disabled]

This allows either settings of [Enabled] or [Disabled] for powering up the computer when the external modem receives a call while the computer is in Soft-off mode. **NOTE:** The computer cannot receive or transmit data until the computer and applications are fully running. Thus connection cannot be made on the first try. Turning an external modem off and then back on while the computer is off causes an initialization string that will also cause the system to power on. Configuration options: [Disabled] [Enabled]

### Wake On LAN or PCI Modem card [Disabled]

Wake-On-LAN or a PCI modem card permits PC bootup from another computer via a network by sending a wake-up frame or signal. Configuration options: [Disabled] [Enabled]

### Wake On PS2 KB / PS2 Mouse [Disabled]

Wake On PS2 KB / PS2 Mouse permits PC bootup from the keyboard or mouse. Configuration options: [Disabled] [Enabled]

**IMPORTANT:** This feature requires an optional network interface with Wake-On-LAN and an ATX power supply with at least 720mA +5V standby power.

## 4. BIOS SETUP

### Wake On USB Device [Disabled]

Wake On USB permits PC bootup from a USB device. Configuration options: [Disabled] [Enabled]

### Automatic Power Up [Disabled]

This allows an unattended or automatic system power up. You may configure your system to power up at a certain time of the day by selecting [Everyday] or at a certain time and day by selecting [By Date]. **NOTE: Automatic Power Up** will not work if the system is powered down by operating systems, such as Windows 98/2000/Millennium, that have ACPI support enabled. Configuration options: [Disabled] [Everyday] [By Date]

### 4.5.2 Hardware Monitor

Hardware Monitor		Item Specific Help
MB Temperature	33°C/91°F	<Enter> to switch between monitoring or ignoring.
CPU Temperature	41°C/105.5°F	
CPU Fan Speed	7670RPM	
Main Fan Speed	7500RPM	
VCORE Voltage	1.6V	
+3.3V Voltage	3.3V	
+5V Voltage	5.0V	
+12V Voltage	12.0V	
F1 Help    ↑ Select Item    +/- Change Values    F5 Setup Defaults		
ESC Exit    ↔ Select Menu    Enter Select Sub-Menu    F10 Save and Exit		

#### MB, CPU Temperature [xxxC/xxxF]

The onboard hardware monitor is able to detect the MB (motherboard) and CPU temperatures. Set to [Ignore] only if necessary.

#### CPU Fan, Main Fan Speed [xxxxRPM]

The onboard hardware monitor is able to detect the CPU fan speed, power supply fan speed, and the chassis fan speed in rotations per minute (RPM). The presence of the fans is automatically detected. Set to [Ignore] only if necessary.

#### VCORE Voltage, +3.3V Voltage, +5V Voltage, +12V Voltage

The onboard hardware monitor is able to detect the voltage output by the onboard voltage regulators. Set to [Ignore] only if necessary.

**NOTE:** If any of the monitored items is out of range, an error message will appear: “Hardware Monitor found an error. Enter Power setup menu for details”. You will then be prompted to “Press **F1** to continue, **DEL** to enter SETUP”.

# 4. BIOS SETUP

## 4.6 Boot Menu

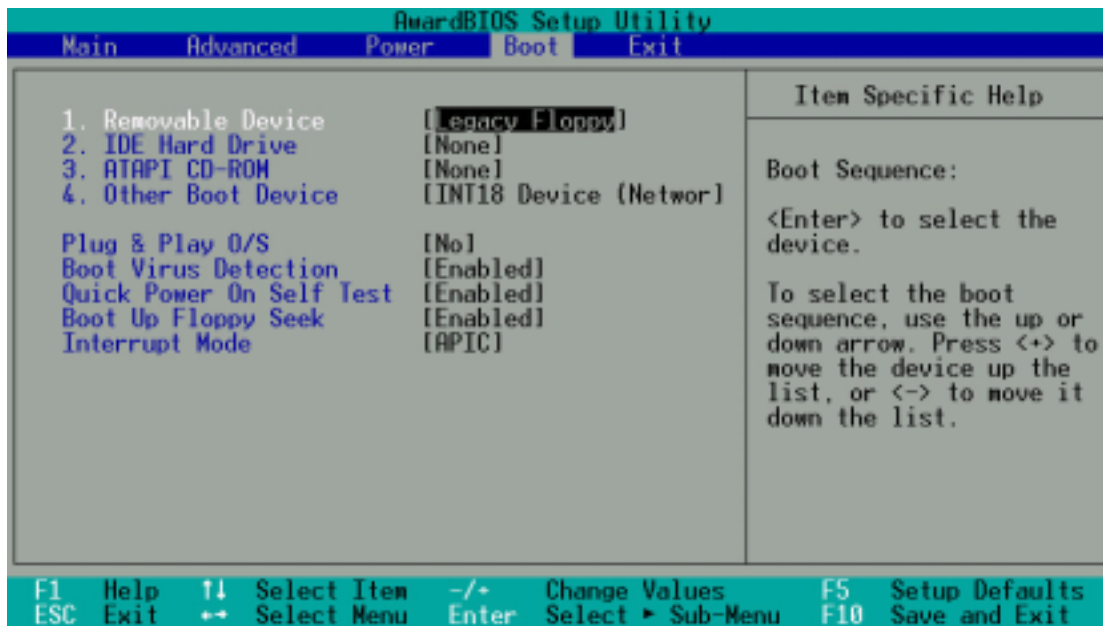

### Boot Sequence

The Boot menu allows you to select among the four possible types of boot devices listed using the up and down arrow keys. By using the <+> or <Space> key, you can promote devices and by using the <-> key, you can demote devices. Promotion or demotion of devices alters the priority which the system uses to search for a boot device on system power up. Configuration fields include **Removable Devices**, **IDE Hard Drive**, **ATAPI CD-ROM**, and **Other Boot Device**.

#### Removable Device [Legacy Floppy]

Configuration options: [Disabled] [Legacy Floppy] [LS120] [ZIP] [ATAPI MO] [USB-FDD] [USB ZIP]

#### IDE Hard Drive

This field allows you to select which IDE hard disk drive to use in the boot sequence. Pressing [Enter] will show the product IDs of all connected IDE hard disk drives.

#### ATAPI CD-ROM

This field allows you to select which ATAPI CD-ROM drive to use in the boot sequence. Pressing [Enter] will show the product IDs of all your connected ATAPI CD-ROM drives.

#### Other Boot Device Select [Disabled]

Configuration options: [Disabled] [SCSI Boot Device] [INT18 Device (Network)]

## 4. BIOS SETUP

---

### **Plug & Play O/S [No]**

This field allows you to use a Plug-and-Play (PnP) operating system to configure the PCI bus slots instead of using the BIOS. When [Yes] is selected, interrupts may be reassigned by the OS. When a non-PnP OS is installed or you want to prevent reassigning of interrupt settings, select the default setting of [No]. Configuration options: [No] [Yes]

### **Boot Virus Detection [Enabled]**

This field allows you to set boot virus detection, ensuring a virus-free boot sector. The system halts and displays a warning message when it detects a virus. If this occurs, you can either allow the operation to continue or use a virus-free bootable floppy disk to restart and investigate your system. Configuration options: [Disabled] [Enabled]

### **Quick Power On Self Test [Enabled]**

This field speeds up the Power-On-Self Test (POST) routine by skipping retesting a second, third, and fourth time. Configuration options: [Disabled] [Enabled]

### **Boot Up Floppy Seek [Enabled]**

When enabled, the BIOS will seek the floppy disk drive to determine whether the drive has 40 or 80 tracks. Configuration options: [Disabled] [Enabled]

### **Interrupt Mode [APIC]**

Configuration options: [APIC] [PIC]



# 4. BIOS SETUP

## 4.7 Exit Menu

Once you have made all of your selections from the various menus in the Setup program, you should save your changes and exit Setup. Select **Exit** from the menu bar to display the following menu:

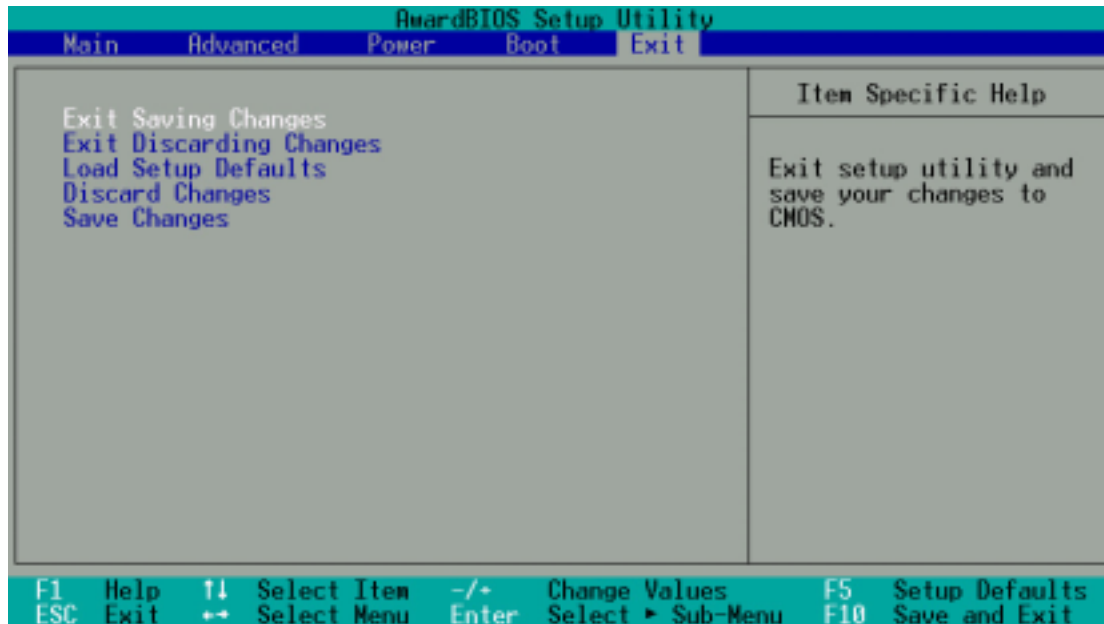

**NOTE:** Pressing <Esc> does not exit this menu. You must select one of the options from this menu or <F10> from the legend bar to exit this menu.

### Exit Saving Changes

Once you are finished making your selections, choose this option from the Exit menu to ensure the values you selected are saved to the CMOS RAM. The CMOS RAM is sustained by an onboard backup battery and stays on even when the PC is turned off. Once this option is selected, a confirmation is asked. Select [Yes] to save changes and exit.

**NOTE:** If you attempt to exit the Setup program without saving your changes, the program will prompt you with a message asking if you want to save your changes before exiting. Pressing <Enter> will then save changes while exiting.

### Exit Discarding Changes

This option should only be used if you do not want to save the changes you have made to the Setup program. If you have made changes to fields other than system date, system time, and password, the system will ask for confirmation before exiting.



# 4. BIOS SETUP

---

## Load Setup Defaults

This option allows you to load the default values for each of the parameters on the Setup menus. When this option is selected or if <F5> is pressed, a confirmation is requested. Select [Yes] to load default values. You can now select **Exit Saving Changes** or make other changes before saving the values to the non-volatile RAM.

## Discard Changes

This option allows you to discard the selections you made and restore the values you previously saved. After selecting this option, a confirmation is requested. Select [Yes] to discard any changes and load the previously saved values.

## Save Changes

This option saves your selections without exiting the Setup program. You can then return to other menus and make changes. After selecting this option, all selections are saved and a confirmation is requested. Select [Yes] to save any changes to the non-volatile RAM.

# 5. SOFTWARE SETUP

---

## 5.1 Install Operating System

You should always use the latest operating system and updates when using new hardware to ensure full compliancy. You may use any version of Windows 98/2000/Millennium, but for Windows 95, you must use OSR 2.0 or later. For Windows NT 4.0, you must use Service Pack 3.0 or later.

## 5.2 Start Windows

When you start Windows 98 for the first time after installing your motherboard, Windows will detect all plug-and-play devices. Follow the Add New Hardware Wizard to install all necessary device drivers. When prompted to restart, select **No** and then follow the setup procedures in this section.

**NOTE:** Because there are various motherboard settings, options, and expansion cards, the following can only be used as a general reference and may not be an exact reflection of your system.

# 5. SOFTWARE SETUP

## 5.3 P4T-EM Motherboard Support CD

**NOTE:** The support CD contents are subject to change at any time without notice.

To begin using your support CD disc, just insert it into your CD-ROM drive and the support CD installation menu should appear. If the menu does not appear, double-click or run **E:\ASSETUP.EXE** (assuming that your CD-ROM drive is drive **E:**).

### 5.3.1 Installation Menu



- **INF Update Utility for 850 Chipset:** Installs INF files in Windows for the following items: System and Graphics, LPC Interface, SM Bus, PCI Bridge, Bus Master IDE, USB Host, and Controllers.
- **Intel Ultra ATA Storage Driver:** Installs Intel's storage driver.
- **Avance AC'97 Audio Controller and Application:** Installs the audio driver and audio program application.
- **Winbond Smart Manager Application:** Installs the PS/SC software application for smart card security and information access.
- **Intel LDCM Administrator Setup:** Installs software to monitor PC systems on the network within the same bridge address with the Client software installed. The administrator should install both Administrator and Client software.
- **Intel LDCM Client Setup:** Installs software to monitor the Client system. The LANdesk Client Manager must be installed to use the hardware manager features.
- **ASUS BIOS Flash Utility for LDCM:** Installs a utility that can remotely flash a client PC's BIOS when used in conjunction with Intel LDCM Administrator.
- **ASUS PC Probe Vx.xx:** Installs a utility to monitor your computer's fan, temperature, and voltages.
- **ASUS Update Vx.xx:** Installs a program to help you update your BIOS or download a BIOS image file.
- **Microsoft DirectX x.x Driver:** Installs Microsoft DirectX driver.

(CLICK THE RIGHT ARROW FOR THE NEXT MENU)

# 5. SOFTWARE SETUP

---

- **PC-CILLIN 2000:** Installs the latest version of the PC-Cillin 2000 anti-virus scanning application. The software supports all Windows platforms with backward compatibility from Win95 to XP.
- **Adobe Acrobat Reader Vx.x:** Installs the Adobe Acrobat Reader software necessary to view user's manuals saved in PDF format. Updated or other language versions of this motherboard's manual is available in PDF format at any of our web sites.
- **ASUS Screen Saver:** Installs the ASUS screen saver.
- **Show Motherboard Information:** Allows you to view information about your motherboard, such as product name, BIOS version, and CPU.
- **Browse Support CD:** Allows you to view the contents of the CD.
- **ReadMe:** Allows you to view the support CD file list and contact information.
- **Exit:** Exits the CD installation menu.

(CLICK THE LEFT ARROW TO RETURN TO THE FIRST MENU)

## 5.3.2 Installation Procedure

On the **Installation Items Menu**, click on the name of the driver or program group to begin installation. Follow the instructions that appear on the setup screens. All drivers and programs install automatically. Refer to the Software Reference section for software operating instructions.

# 6. SOFTWARE REFERENCE

## 6.1 Winbond Smart Manager

The *Winbond Smart Manager* is a clever utility that helps secure the PC with a *Smart Card Reader* and a smart card containing a mini-chip insert, like a *GSM cell phone SIM card*. Once a smart card reader is configured, set up the *Smart Manager* software utility for “boot up” or “always on” system security.

### 6.1.1 Setting Up Smart Manager

**Connect** the *smart card reader* to the P4T-EM; (refer to 3. *Hardware Setup* for the *connector* location.) **Boot up** the PC and enter **BIOS** (press <del>) to change the configuration to accept smart card hardware: in the *Advanced BIOS* menu select the *I/O Device Configuration* sub-menu, go to **UART2** and select **Smart Card Read**, save and exit.

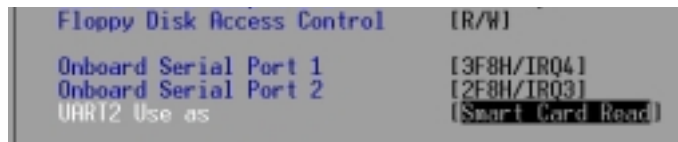

Finish booting up. Insert the ASUS Support CD and click on the selection: *Winbond Smart Manager Application*. The auto-installer prompts to install the *Base Components* and after doing show displays a *readme* file. Next, immediately install the *Smart Card Driver Library* as prompted. Finally, install the *Winbond Smart Manager* application as prompted.

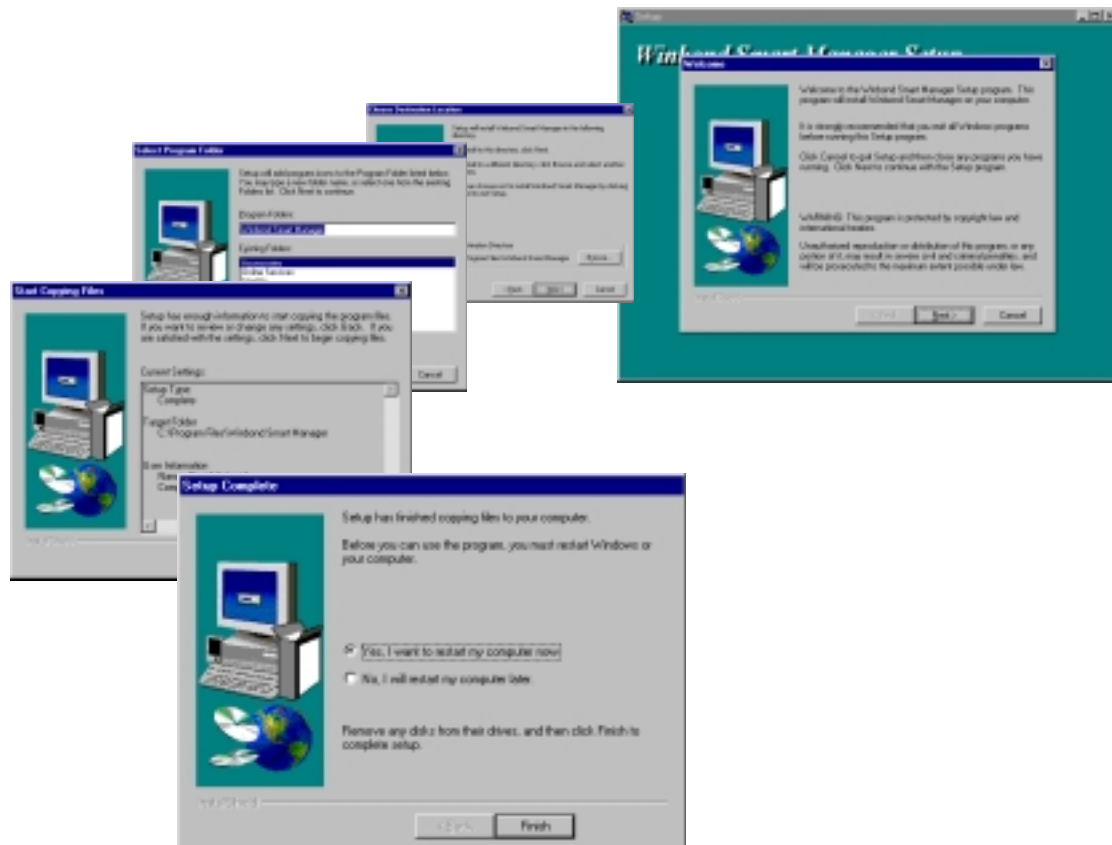

## 6. SOFTWARE REFERENCE

The auto-installer implements all of the drivers, base components and displays the *Winbond Smart Manager* program groups. **Restart.** *Windows* should auto-detect the *smart card reader* and install its system drivers.



**NOTE:** Do not install system components or *Winbond* applications *unless* you install a smart card *reader*. Smart card system software components support various types of smart card applications; all system components are compatible with *Windows 98, ME* and *2000*. However, the *Winbond Smart Manager* application is readily compatible *only* with *Windows 98* and *ME*.

# 6. SOFTWARE REFERENCE

## 6.1.2 Starting to Use Smart Manager

After installing the software, start *Windbond Smart Manager* for the first time: select the **Programs** menu from the **Start** bar and select the **Windbond** program group. When you click the program application, an **icon** is created for the **Logon Smart Card** software in the bottom right hand corner of the screen.

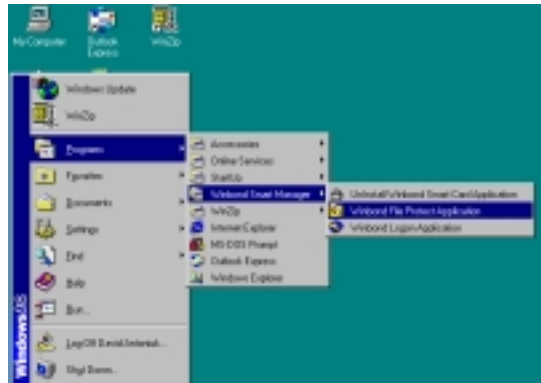

The new **icon** resembles a key.



**Right click** on the icon and select **Setting Logon Smart Card**.

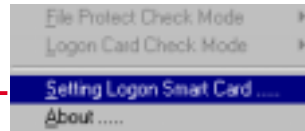

Click the **Add New** button and then select the type of card you are using. Insert the **smart card** into the card reader, then enter your name and any remarks into the fields. Click **OK**.

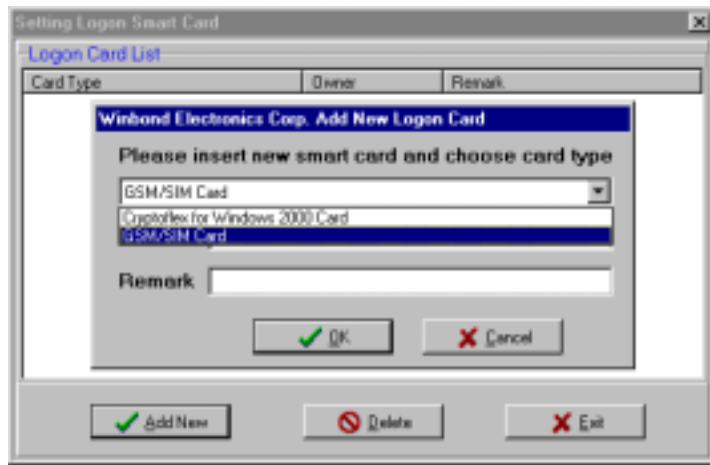

The card reader detects the smart card ID. *Smart Manager* registers the smart card for security capability and prompts to click **OK**. The card's **security status** is displayed in the main program window.

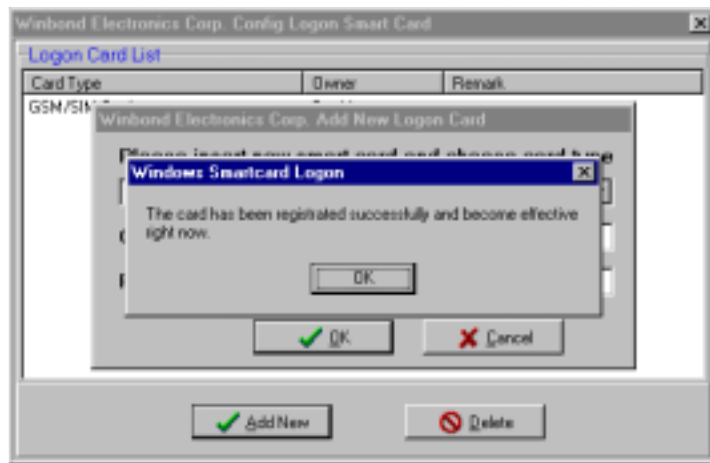

## 6. SOFTWARE REFERENCE

### 6.1.3 Smart Manager Modes

Return to the *Windbond Smart Manager* icon on the bottom right hand corner of the *Windows* screen. Select the **Logon Card Check Mode** to choose the security mode. Three basic modes are available:

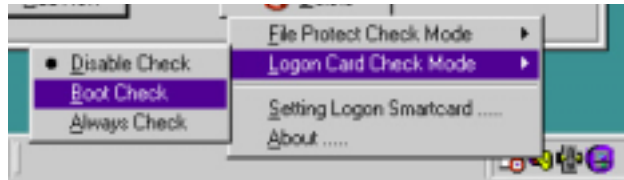

1. **Disable Check** renders the *Smart Manager* security system inoperative.
2. **Boot Check** enables the *Smart Manager* security system for start up. The user must insert the smart card into the reader during start up in order to complete the *Windows* boot up process. In this mode, the user may remove the smart card and continue to use the PC after the start cycle is complete. If no smart card, or the wrong one, is inserted during boot up, the PC displays the *Smart Manager Protection Screen*:

Whenever the *Smart Manager Protection Screen* is displayed, the computer is secured and impenetrable.



3. **Always Check** configures the *Smart Manager* to require that the user insert the smart card during start up; then, if the card is removed at any time during the operation of the PC, the *Smart Manager* protection screen will automatically pop up and the PC is secure until the card is reinserted.

**File Protect Check Mode:** This is a sub-program used to encrypt and decode individual files stored in the system using a smart card as a key.

**NOTE:** Do take care **not to lose** your smart card or you may not be able to restart the PC or decode encrypted files. Test each new smart card to ensure that it is completely compatible with the card reader; the *Read2-In-01 Smart Card Reader* is designed only to read cards with the standard PC/SC mini-chip configuration.



# 6. SOFTWARE REFERENCE

## 6.2 ASUS PC Probe

ASUS PC Probe is a convenient utility to continuously monitor your computer system's vital components, such as fan rotations, Voltages, and temperatures. It also has a utility that lets you review useful information about your computer, such as hard disk space, memory usage, and CPU type, CPU speed, and internal/external frequencies through the DMI Explorer.

### 6.2.1 Starting ASUS PC Probe

When ASUS PC Probe starts, a splash screen appears allowing you to select whether or not to show the screen the next time you open PC Probe. To bypass this startup screen, clear the **Show up in next execution** check box.



To start **ASUS PC Probe**, click the Windows **Start** button, point to **Programs**, and then **ASUS Utility**, and then click **Probe Vx.xx**.

The PC Probe icon  will appear on the taskbar's system tray indicating that ASUS PC Probe is running. Clicking the icon will allow you to see the status of your PC.

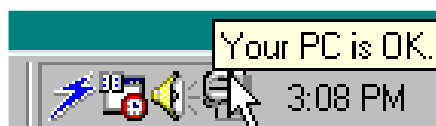

# 6. SOFTWARE REFERENCE

## 6.2.2 Using ASUS PC Probe Monitoring

### Monitor Summary

Shows a summary of the items being monitored.



### Temperature Monitor

Shows the PC's temperature.

Temperature Warning threshold adjustment  
(Move the slider up to increase the threshold level or down to decrease the threshold level)



### Fan Monitor

Shows the PC's fan rotation.

Fan Warning threshold adjustment  
(Move the slider up to increase the threshold level or down to decrease the threshold level)



### Voltage Monitor

Shows the PC's voltages.

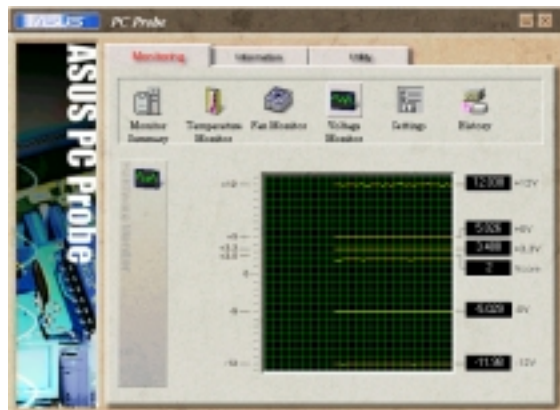

# 6. SOFTWARE REFERENCE

## Settings

Lets you set threshold levels and polling intervals or refresh times of the PC's temperature, fan rotation, and voltages.



## CPU Cooling System Setup

Lets you select when to enable software CPU cooling. When **When CPU Overheated** is selected, the CPU cooling system is enabled whenever the CPU temperature reaches the threshold value.

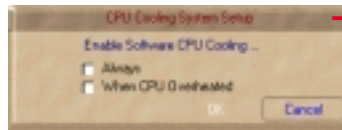

## History

Lets you record the current monitoring activity of a certain component of your PC for future reference.



## Information

### Hard Drives

Shows the used and free space of the PC's hard disk drives and the file allocation table or file system used.



# 6. SOFTWARE REFERENCE

## Memory

Shows the PC's memory load, memory usage, and paging file usage.



## Device Summary

Shows a summary of devices in your PC.



## DMI Explorer

Shows information pertinent to the PC, such as CPU type, CPU speed, and internal/external frequencies, and memory size.



## Utility

Lets you run programs outside of the ASUS Probe modules. To run a program, click **Execute Program**.





# 6. SOFTWARE REFERENCE

## 6.2.3 ASUS PC Probe Task Bar Icon

Right-clicking the PC Probe icon will bring up a menu to open or exit ASUS PC Probe and pause or resume all system monitoring.



When the ASUS PC Probe senses a problem with your PC, portions of the ASUS PC Probe icon changes to red, the PC speaker beeps, and the ASUS PC Probe monitor is displayed.

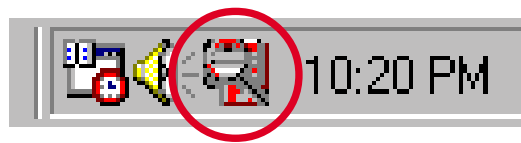

# 6. SOFTWARE REFERENCE

## 6.3 ASUS Live Update

ASUS LiveUpdate is a utility that allows you to update your motherboard's BIOS and drivers. The use of this utility requires that you are properly connected to the Internet through an **Internet Service Provider (ISP)**.

**1. Start ASUS Update**

Launch the utility from your Windows Start menu:**Programs/AsusUpdate**

**2. Select an update method.**



**3. If you selected updating/downloading from the Internet, you will need to select an Internet site. Choose the site that is closest to you or click **Auto Select**.**



**4. From the FTP site, select the BIOS version that you wish to download. Click **Next**.**

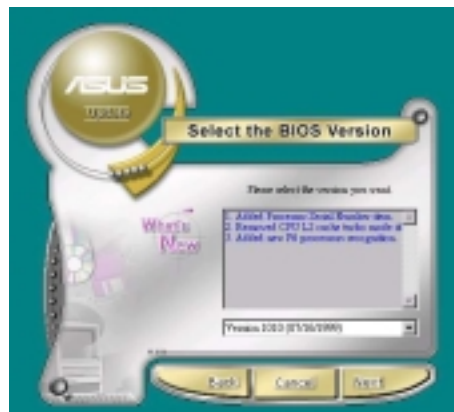

**5. Follow the instructions on the succeeding screens to complete the update process. If you selected the option to update the BIOS from a file, a window pops up prompting you to locate the file. Select the file, click **Save**, then follow the screen instructions to complete the update process.**



# 6. SOFTWARE REFERENCE

## 6.4 CyberLink PowerPlayer SE

CyberLink PowerPlayer SE is an intelligent software player that can automatically detect and playback all kinds of video/audio files, CD and MP3 files as well. This is the only software you need for all types of video and audio files. No need to waste time identifying your file types.

### 6.4.1 Starting CyberLink PowerPlayer SE

To start **CyberLink Power Player**, click the Windows **Start** button, point to **Programs**, and then **CyberLink PowerPlayer SE**, and then click **PowerPlayer**.

### 6.4.2 CyberLink PowerPlayer Control Panel

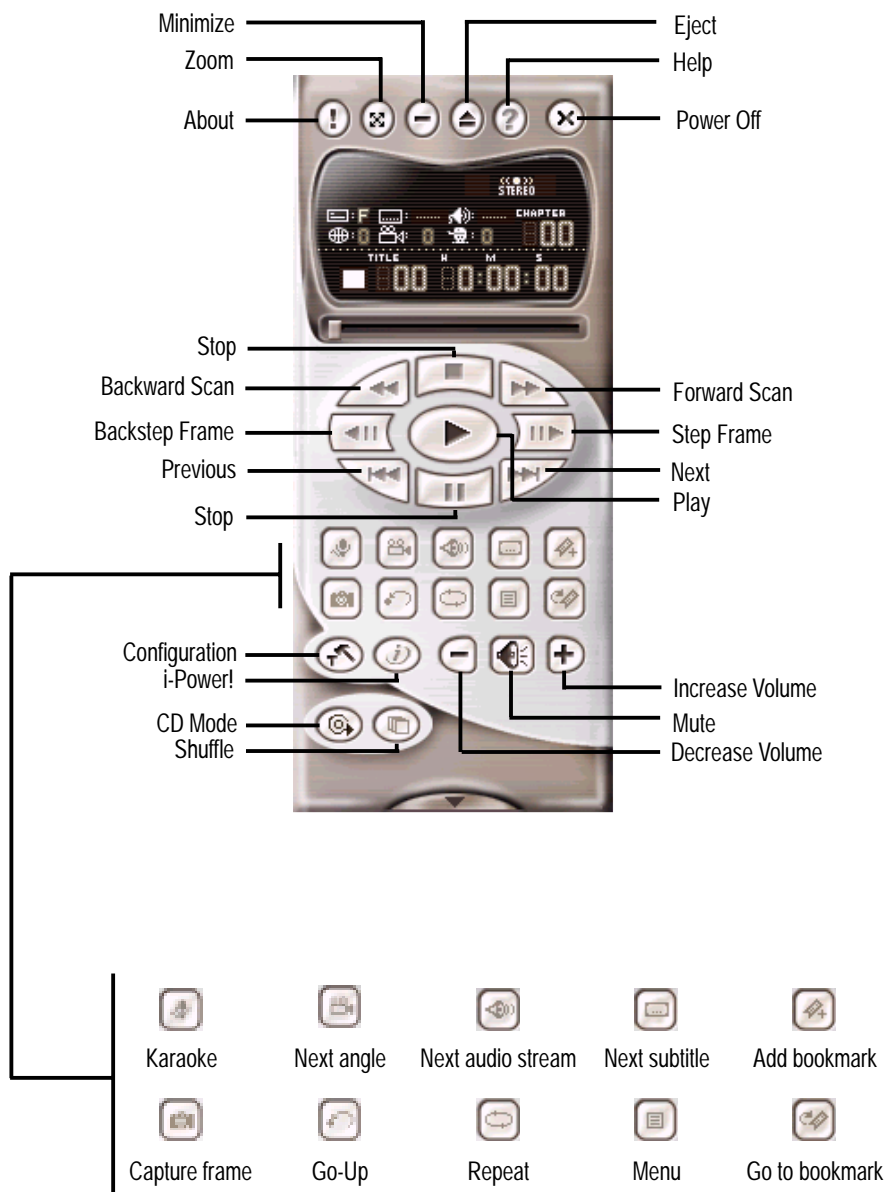

## 6. SOFTWARE REFERENCE

---

### 6.5 CyberLink VideoLive Mail

CyberLink's VideoLive Mail Plus Ver 3.0 (a.k.a. VLM 3) is a convenient and excellent way to create professional quality video mails from PC video/audio input devices and to send the mails to any recipients via VLM 3's built-in e-mail system through the Internet. VLM 3's mails comprise video, sound, or snapshot information; and thus may convey the most profound information to target audiences. It is very convenient for mail recipients who do not need to install additional software component in order to view VLM 3 mails.

VLM 3 works as a very applicant sales tool. It efficiently delivers profound and live product information to your target customers without costing a fortune. VLM 3 also helps corporate managers easily give vivid speeches and broadcast through corporate E-mail system. For personal or home users, VLM 3 easily records live video clips allowing users to send them to friends or family members across the Internet.

VLM 3 loads video messages from PC cameras, digital camcorders, analog camcorder via video capture cards, or from an existing AVI video clips, and captures audio messages from PC microphones. Video and audio messages are encoded at a very high compressed rate in a real-time mode. From data input, data conversion, to sending video mails via Internet, or saving data to disks, the whole procedure is done in an easy and continuous process.

VLM 3's video clip compression rate is up to 1:900, and its playback rate is up to 30 frame per second. VLM 3 provides CIF (352 x 288 pixel) display resolution, and support true color configuration. A one-minute video mail with QCIF (176 x 144) resolution takes up less than 500KB of memory, making it easy to transmit and save mail. Users may always adjust resolution and recording parameters for different purpose.

VLM 3 supports all the hardware devices that are compliant with Video for Windows standard. Video for Windows is a well-accepted and well-tested standard. Thus, users do not have to worry about compatibility issues.



## 6. SOFTWARE REFERENCE

### 6.5.1 Starting VideoLive Mail

To start **VideoLive Mail**, click the Windows **Start** button, point to **Programs**, and then **CyberLink VideoLive Mail**, and then click **VideoLive Mail x.x**. VLM 3's Setup Wizard will start and guide you through configuring the video and audio input peripherals and to setup the e-mail environment.

1. Setup Wizard first will prompt a dialog to confirm that you want to configure the hardware and E-mail setting. Click **Yes** to continue the system parameter configuration.
2. The e-mail configuration screen appears. You will need to enter your name and the e-mail address. Click **Next** to continue.
3. The Internet e-mail configuration screen appears. You may choose to use the VLM 3 built-in E-mail functionality (SMTP mail), or use MAPI compliant e-mail system. Consult your ISP or MIS staff for the E-mail server IP address if you are not sure. Click **Next** to continue.
4. Then the Video Configuration screen shows up. You may have to specify the video driver for VLM 3, if there are several video-input devices installed. Then configure the number of video frames to be captured per second. Note that the more frames you choose, the bigger the file size will be. Click **Next** to continue.
5. Then the Setup Wizard will then search for the GSM CODECS module for audio compression, and prompt you with the result. Click **Next** to continue.
6. Setup Wizard then tests the audio volume during playing and recording. Click **Next** when ready.
7. Configuration done. Click **Finish** to complete the environmental setting procedure.

### 6.5.2 CyberLink VideoLive Mail User Interface



(This page was intentionally left blank.)

# 7. APPENDIX

## 7.1 Glossary

### 1394

1394 is the IEEE designation for a high performance serial bus that offers data transfers at 100/200/400 Mbps. This serial bus defines both a back plane physical layer and a point-to-point cable-connected virtual bus. The primary application of the cable version is the integration of I/O connectivity at the back panel of personal computers using a low-cost, scalable, high-speed serial interface. The 1394 standard also provides new services such as live connect/disconnect capability for external devices including disk drives, printers and hand-held peripherals such as scanners and cameras. This is a new standard to complement the slower USB interface and to compete with the more expensive SCSI interface.

### AC97 (Audio Codec '97)

AC '97 is the next step in enabling PCs with audio quality comparable to consumer electronics devices. The specification defines new cost-effective options to help integrate the components necessary to support next-generation audio-intensive PC applications such as DVD, 3-D multiplayer gaming and interactive music. The specification also defines new extensions supporting modem and docking to help both desktop and mobile manufacturers adopt these new technologies more quickly and cost-effectively. This specification uses software emulation to compete with the PCI SoundBlaster specification.

### ACPI (Advanced Configuration and Power Interface)

The ACPI specification defines a cross-platform interface designed to support many operating systems. ACPI defines a flexible and abstract hardware interface that provides a standard way to integrate power management features throughout a PC system, including hardware, operating system and application software. This enables the system to automatically turn ON and OFF peripherals such as CD-ROMs, network cards, hard disk drives, and printers, as well as consumer devices connected to the PC such as VCRs, TVs, phones, and stereos. With this technology, peripherals will also be able to activate the PC. For example, inserting a tape into a VCR can turn on the PC, which could then activate a large-screen TV and high-fidelity sound system.

### AGP (Accelerated Graphics Port)

An interface specification that enables high-performance 3D graphics on mainstream PCs. AGP was designed to offer the necessary bandwidth and latency to perform texture mapping directly from system memory.

Bus	Bus Frequency	Bandwidth	Data Transfer Rate
PCI	33MHz	33MHz	133MByte/sec
AGP 1X	66MHz	66MHz	266MByte/sec
AGP 2X	66MHz	133MHz	512MByte/sec
AGP 4X	66MHz	266MHz	1024MByte/sec

**Backup.** A copy of a file, directory, or volume on a separate storage device from the original. This copy is for the purpose of data retrieval in case the original is accidentally erased, damaged, or destroyed.

### BIOS (Basic Input/Output System)

BIOS is a set of routines that affect how the computer transfers data between computer components, such as memory, disks, and the display adapter. The BIOS instructions are built into the computer's read-only memory. BIOS parameters can be configured by the user through the BIOS Setup program. The BIOS can be updated using the provided utility to copy a new BIOS file into the EEPROM.

### Bit (Binary Digit)

Represents the smallest unit of data used by the computer. A bit can have one of two values: 0 or 1.

# 7. APPENDIX

---

## **Boot**

Boot means to start the computer operating system by loading it into system memory. When the manual instructs you to “boot” your system (or computer), it means to turn ON your computer. “Reboot” means to restart your computer. When using Windows 95 or later, selecting “Restart” from “Start | Shut Down...” will reboot your computer.

## **Bus Master IDE**

PIO (Programmable I/O) IDE requires that the CPU be involved in IDE access and waiting for mechanical events. Bus master IDE transfers data to/from the memory without interrupting the CPU. Bus master IDE driver and bus master IDE hard disk drives are required to support bus master IDE mode.

## **Byte (Binary Term)**

One byte is a group of eight contiguous bits. A byte is used to represent a single alphanumeric character, punctuation mark, or other symbol.

**Cache Memory.** A type of RAM that allows a faster from the CPU than a regular RAM. The cache memory eliminates the CPU wait state. When the CPU reads data from the main memory, a copy of this data is stored in the cache memory. The next time the same address, the data is transferred from the cache memory instead of from the main memory.

**CODEC (Compressor/Decompressor).** A software component that translates video or audio between its uncompressed form and the compressed form in which it is stored.

## **COM Port**

COM is a logical device name used by to designate the computer serial ports. Pointing devices, modems, and infrared modules can be connected to COM ports. Each COM port is configured to use a different IRQ and address assignment.

## **Concurrent PCI**

Concurrent PCI maximizes system performance with simultaneous CPU, PCI and ISA bus activities. It includes multi-transaction timing, enhanced write performance, a passive release mechanism and support for PCI 2.1 compliant delayed transactions. Concurrent PCI provides increased bandwidth, reduced system latencies, improves video and audio performance, and improves processing of host based applications.

## **CPU (Central Processing Unit)**

The CPU, sometimes called “Processor,” actually functions as the “brain” of the computer. It interprets and executes program commands and processes data stored in memory. Currently, there are socket 370 (for Pentium III FC-PGA and Celeron-PPGA), socket 7 (for Pentium, AMD, Cyrix, IBM), slot 1 (for Pentium II and III), slot 2 (for Xeon), and slot A (for AMD) processors.

## **Device Driver**

A device driver is a special set of instructions that allows the computer’s operating system to communicate with devices such as VGA, audio, printer, or modem.

## **DOS (Disk Operating System)**

DOS is the foundation on which all other programs and software applications operate, including Windows. DOS is responsible for allocating system resources such as memory, CPU time, disk space, and access to peripheral devices. For this reason, DOS constitutes the basic interface between you and your computer.

## **DRAM (Dynamic Random Access Memory)**

A type of RAM that requires refresh cycles to prevent the loss of the data stored in it. There are several different types of DRAM such as, EDO DRAM (Extended Data Output DRAM), SDRAM (Synchronous DRAM), and RDRAM (Rambus DRAM) and DDR DRAM, (Double-Data Rate DRAM).

## **Flash ROM**

non-volatile memory device that retains its data even when power is removed. This device is similar to EPROM, but unlike EPROM which can be erased only using an ultra-violet light, flash ROM can be electrically erased. Flash ROM is normally used for system BIOS, which initiates hardware devices and sets up necessary parameters for the OS. Since the flash ROM contents can be modified, users can easily update the BIOS..

# 7. APPENDIX

---

## **IDE (Integrated Drive Electronics)**

IDE devices integrate the drive control circuitry directly on the drive itself, eliminating the need for a separate adapter card (in the case for SCSI devices). UltraDMA/33 IDE devices can achieve up to 33MB/Sec transfer.

## **I/O (Input/Output)**

The data transfers from the input devices like a keyboard, mouse, or scanner, to the output devices like a printer or the monitor screen.

## **I/O Address**

The specific memory location for a particular device. Two devices cannot share the same I/O address space.

## **IrDA (Infrared Data Association)**

An international organization that creates and promotes inter-operable, low cost, infrared data interconnection standards that support a walk-up, point-to-point model. The IrDA protocol is designed to support transmission of data between two devices over short-range point-to-point infrared at speeds between 9.6Kbps and 4Mbps.

## **ISP (Internet Service Provider)**

A company that provides customer access to the Internet and the World Wide Web for a fee. The ISP also provides Internet utilities and services like e-mail, newsgroup, weather reports, and a host of others. The user can connect to the ISP using a modem installed in the computer and connected to a phone line.

## **LPT Port (Line Printer Port)**

Logical device name reserved by DOS for the computer parallel ports. Each LPT port is configured to use a different IRQ and address assignment.

## **MMX**

A set of 57 new instructions designed to accelerate multimedia and communications applications, such as 3D video, 3D sound, video conference.

## **Modem**

A device that allows a computer to talk to another computer through the phone system.

## **Network**

An interconnected computer system linked by telephone wires, or other means.

## **OnNow**

The OnNow design initiative is a comprehensive, system-wide approach to system and device power control. OnNow is a term for PC that is always ON but appears OFF and responds immediately to user or other requests. The OnNow design initiative involves changes that will occur in the Microsoft Windows operating system, device drivers, hardware, and applications, and also relies on the changes defined in the Advanced Configuration and Power Interface (ACPI) specification.

## **PC100/133**

This is an industry-standard designation for memory capacity as a measure of the speed of the memory bus. New platform requirements ensure that memory does not become a bottleneck to system performance.

## **PCI Bus (Peripheral Component Interconnect Local Bus)**

PCI bus is a standard specification that defines a 32-bit data bus interface.

## **PCI Bus Master**

The PCI Bus Master can perform data transfer without local CPU help and the CPU can be treated as one of the Bus Masters. PCI 2.1 supports concurrent PCI operation to allow the local CPU and bus master to work simultaneously.

## **POST (Power On Self Test)**

Powering on the computer initiates the POST, a series of software-controlled diagnostic tests. The POST checks system memory, the motherboard circuitry, the display, the keyboard, the diskette drive, and other I/O devices

# 7. APPENDIX

---

## **PS/2 Port**

PS/2 ports are based on IBM Micro Channel Architecture. This type of architecture transfers data through a 16-bit or 32-bit bus. A PS/2 mouse and/or keyboard may be used on ATX motherboards.

## **RDRAM (Rambus DRAM)**

Developed by Rambus, Inc., this type of memory can deliver up to 1.6GB of data per second. RDRAM is the first interface standard that can be directly implemented on high performance VLSI components such as, CMOS DRAMs, memory controllers, and graphics/video ICs.

**RAM (Random Access Memory).** The computer's primary storage area used to write, store, and retrieve information and program instructions which are passed to the CPU for processing. The information in RAM can be repeatedly re-written with new data. Compared to other storage media like magnetic tape, floppy disk, and hard disk, RAM has an extraordinarily fast access rate. RAM, however, is volatile, which means that the data stored in it are lost when the system power is turned off, or if power glitches occur. See also DRAM and SDRAM.

## **ROM (Read Only Memory)**

ROM is nonvolatile memory used to store permanent programs (called firmware) used in certain computer components. Flash ROM (or EEPROM) can be reprogrammed with new programs (or BIOS).

## **SCSI (Small Computer System Interface)**

High speed multi-threaded I/O interface defined by the X3T9.2 committee of the American National Standards Institute (ANSI) for connecting many peripheral devices. The standard started from 10MBytes/sec to 160MBytes/sec available today.

## **SDRAM (Synchronous DRAM)**

A type of DRAM with access signals that are synchronized with the CPU clock, eliminating the delay associated with data transfers between the CPU and memory. SDRAM takes memory access away from the CPU control; internal registers in the memory accept the request, and lets the CPU do something else while the data requested is assembled for the next time the CPU talks to the memory.

## **SPD for SDRAM module**

Serial Presence Detect (SPD) is most like an ID detect for SDRAM module, it using a EEPROM component on DIMM module for storing module configuration information inside. The Serial Presence Detect function is implemented using a 2048 bit EEPROM component. This nonvolatile storage device contains data programmed by the DIMM manufacturer that identifies the module type and various SDRAM organization and timing parameters.

## **System Disk**

A system disk contains the core file of an operating system that boots up the operating system.

**TCP/IP (Transmission Control Protocol/Internet Protocol).** The communications protocol used by the UNIX system and the Internet. TCP checks for lost packets, puts the data from multiple packets into the correct order, and requests that missing or damaged packets be resent.

## **USB (Universal Serial Bus)**

A 4-pin serial cable bus that allows up to 127 plug and play computer peripherals such as keyboard, mouse, joystick, scanner, printer, modem, and monitor to share a bandwidth through a host scheduled token based protocol. This allows attaching or detaching while the host and other peripherals are in operation. Supports synchronous and asynchronous transfer types over the same set of wires up to 12Mbit/sec. USB 2.0 provides twice the transfer rate compared to USB 1.0 and competes with the 1394 standard.

## **Wake-On-LAN**

Computer will automatically wake-up upon receiving a wake-up packet through a Network interface when it is under power soft-off, suspend or sleep mode.

# INDEX

---

## A

AC PWR Loss Restart 68  
Accelerated Graphics Port 29  
Accessories. *See also Leads*  
AGP 29  
AGP Slots 29  
ASUS PC Probe  
    Using 77  
ASUS Update  
    Using 82  
ATAPI CD-ROM 70  
ATX Power Switch Lead 40  
Automatic Power Up 69

## B

BIOS  
    Beep Code 41  
    Shadow Configuration 65  
BIOS Beep Codes 41  
Boot Sequence 70  
Boot Up Floppy Seek 71  
Boot Up NumLock Status 54  
Boot Virus Detection 71

## C

Central Processing Unit 23  
Central Processing Unit (CPU)  
    CPU socket 9  
    External Frequency 18, 20  
CHS Capacity 53  
COM 2 Bracket 31  
Connectors  
    ASUS EZ Plug 9  
    ATX power 9  
    Floppy disk 9  
    Floppy Disk Drive 32  
    Game/MIDI 9  
    IDE 9, 33  
    Infrared Module 15, 37  
    Internal Audio 15, 35  
    Parallel Port 31  
    PS/2 Keyboard 30  
    PS/2 Mouse 30  
    Serial Port 31  
    SMB 38  
    USB 31  
CPU Speed 56  
CPU Temperature 69  
CyberLink  
    PowerPlayer SE 83  
    VideoLive Mail 84  
CyberLink PowerPlayer SE  
    Using 83  
CyberLink VideoLive Mail  
    Using 84

Cylinders 52

## D

DIP Switches 17  
Discard Changes 73

## E

ECP DMA Select 62  
Exit Discarding Changes 72  
Exit Saving Changes 72  
Expansion Cards  
    AGP Pro 29  
    Assigning IRQs 28

## F

Floppy 3 Mode Support 50  
Floppy Disk Drive Connector 32

## G

Glossary 87

## H

Halt On 55  
Hardware Setup  
    CPU Installation 23  
    Procedure 16  
Head 53  
Headers  
    USB 35, 36  
Heatsink  
    installation 24

## I

IDE Activity LED Lead 15, 37  
IDE Connectors 33  
IDE Hard Drive 70  
Infrared Module Connector 15, 37  
Installation  
    CPU 23  
Installed Memory 55  
Internal Audio Connector 35  
Interrupts  
    Request Table 28  
    Standard Assignments 28  
IRQ XX Used By ISA 64

## J

JumperFree™ Mode 15

## K

Keyboard Lock Switch Lead 40

# INDEX

---

## L

- LAN
  - Jumper Setting 19
- Language 55
- Leads
  - IDE Activity LED 37
- Legacy Diskette A 50
- Legacy Diskette B 50
- Load Setup Defaults 73

## M

- Maximum LBA Capacity 53
- MB Temperature 69
- Memory Hole At 15M-16M 60
- Motherboard
  - Settings 16
- Multi-Sector Transfers 53

## O

- Onboard AC97 Modem Controlle 61
- Onboard PCI IDE Enable 60
- Onboard Serial Port 1 61
- Onboard Serial Port 2 61
- OS/2 Onboard Memory > 64M 57
- Other Boot Device Select 70

## P

- Parallel Port Connector 31
- Parallel Port Mode 62
- PCI Latency Timer 63
- PCI/VGA Palette Snoop 63
- PIO Mode 53
- Plug & Play O/S 71
- Power Management 66
- PowerPlayer SE
  - Using 83
- Procedure
  - CPU Installation 23
- Procedures
  - Updating BIOS 44
- PS/2 Keyboard Connector 30
- PS/2 Keyboard Port 9
- PS/2 Mouse Connector 30
- PS/2 Mouse Port 9
- PWR Up On Modem Act 68

## Q

- Quick Power On Self Test 71

## R

- Removable Device 70
- Reset Switch Lead 40

## S

- Save Changes 73
- Sector 53
- Serial Port Connectors 31
- Serial ports 9
- Settings
  - Onboard Audio 19
- SMART Monitoring 53
- SMB Connector 38
- SMI Lead 40
- Starting Up 41
- Supervisor Password 55
- Suspend Mode 67
- System Date 50
- System Memory 21
- System Message LED Lead 40
- System Power LED Lead 40
- System Time 50

## T

- Translation Method 52
- Type 51

## U

- UART2 Use Standard Infrared 62
- Ultra DMA Mode 53
- Universal Serial Bus Ports 31
- Updating Your BIOS 43
- USB Function 63
- USB Headers 35, 36
- USB Legacy Support 57
- USB ports 9
- Using
  - ASUS PC Probe 77
  - ASUS Update 82
  - PowerPlayer SE 83

## V

- VCORE Voltage 69
- Video ROM BIOS Shadow 65
- VideoLive Mail 84
  - Using 84
- Voltage
  - +12 69
  - +3.3 69
  - +5 69
  - VCORE 69

## W

- Wake On LAN 69
- Wake On Ring 68