



# *A7V266-MX*

User Guide

# Motherboard

**E1444**

**First Edition V1**

**October 2003**

**Copyright © 2003 ASUSTeK COMPUTER INC. All Rights Reserved.**

No part of this manual, including the products and software described in it, may be reproduced, transmitted, transcribed, stored in a retrieval system, or translated into any language in any form or by any means, except documentation kept by the purchaser for backup purposes, without the express written permission of ASUSTeK COMPUTER INC. ("ASUS").

Product warranty or service will not be extended if: (1) the product is repaired, modified or altered, unless such repair, modification or alteration is authorized in writing by ASUS; or (2) the serial number of the product is defaced or missing.

ASUS PROVIDES THIS MANUAL "AS IS" WITHOUT WARRANTY OF ANY KIND, EITHER EXPRESS OR IMPLIED, INCLUDING BUT NOT LIMITED TO THE IMPLIED WARRANTIES OR CONDITIONS OF MERCHANTABILITY OR FITNESS FOR A PARTICULAR PURPOSE. IN NO EVENT SHALL ASUS, ITS DIRECTORS, OFFICERS, EMPLOYEES OR AGENTS BE LIABLE FOR ANY INDIRECT, SPECIAL, INCIDENTAL, OR CONSEQUENTIAL DAMAGES (INCLUDING DAMAGES FOR LOSS OF PROFITS, LOSS OF BUSINESS, LOSS OF USE OR DATA, INTERRUPTION OF BUSINESS AND THE LIKE), EVEN IF ASUS HAS BEEN ADVISED OF THE POSSIBILITY OF SUCH DAMAGES ARISING FROM ANY DEFECT OR ERROR IN THIS MANUAL OR PRODUCT.

SPECIFICATIONS AND INFORMATION CONTAINED IN THIS MANUAL ARE FURNISHED FOR INFORMATIONAL USE ONLY, AND ARE SUBJECT TO CHANGE AT ANY TIME WITHOUT NOTICE, AND SHOULD NOT BE CONSTRUED AS A COMMITMENT BY ASUS. ASUS ASSUMES NO RESPONSIBILITY OR LIABILITY FOR ANY ERRORS OR INACCURACIES THAT MAY APPEAR IN THIS MANUAL, INCLUDING THE PRODUCTS AND SOFTWARE DESCRIBED IN IT.

Products and corporate names appearing in this manual may or may not be registered trademarks or copyrights of their respective companies, and are used only for identification or explanation and to the owners' benefit, without intent to infringe.

# Contents

Contents .....	iii
Notices .....	v
Safety information .....	vi
A7V266-MX specification summary .....	vii

## Chapter 1: Product introduction

1.1	Welcome! .....	1-2
1.2	Package contents .....	1-2
1.3	Special features .....	1-2
1.4	Motherboard components .....	1-4
1.5	Motherboard layout .....	1-7
1.6	Motherboard installation .....	1-8
	1.6.1 Placement direction .....	1-8
	1.6.2 Screw holes .....	1-8
1.7	Before you proceed .....	1-9
1.8	Central Processing Unit (CPU) .....	1-10
	Installing the CPU .....	1-10
1.9	System memory .....	1-11
	Installing a DIMM .....	1-11
1.10	Expansion slots .....	1-12
	1.10.1 Configuring an expansion card .....	1-12
	1.10.2 AGP slot .....	1-13
	1.10.3 PCI slots .....	1-13
1.11	Switch and jumpers .....	1-14
1.12	Connectors .....	1-17

## Chapter 2: BIOS information

2.1	Managing and updating your BIOS .....	2-2
	2.1.1 Creating a bootable floppy disk .....	2-2
	2.1.2 Updating BIOS using the AwardBIOS Flash Utility .....	2-3
	2.1.3 CrashFree BIOS feature .....	2-4
2.2	BIOS beep codes .....	2-5
2.3	BIOS Setup program .....	2-5
	2.3.1 BIOS menu bar .....	2-6
	2.3.2 Legend bar .....	2-6
2.4	Main Menu .....	2-8
	2.4.1 IDE Primary Master/Slave IDE Secondary Master/Slave .....	2-10

# Contents

2.5	Advanced Menu .....	2-12
2.5.1	Chip Configuration .....	2-13
2.5.2	I/O Device Configuration .....	2-18
2.5.3	PCI Configuration .....	2-20
2.5.4	Frequency/Voltage Control .....	2-22
2.6	Power Menu .....	2-23
2.6.1	Power Up Control .....	2-25
2.6.2	Hardware Monitor .....	2-26
2.7	Boot Menu .....	2-27
2.8	Exit Menu .....	2-28

## Chapter 3: Software support

3.1	Installing an operating system .....	3-2
3.2	Support CD information .....	3-2
3.2.1	Running the support CD .....	3-2
3.2.2	Drivers menu .....	3-3
3.2.3	Utilities menu .....	3-4
3.2.4	ASUS contact information .....	3-5

# Notices

## Federal Communications Commission Statement

This device complies with FCC Rules Part 15. Operation is subject to the following two conditions:

- This device may not cause harmful interference, and
- This device must accept any interference received including interference that may cause undesired operation.

This equipment has been tested and found to comply with the limits for a Class B digital device, pursuant to Part 15 of the FCC Rules. These limits are designed to provide reasonable protection against harmful interference in a residential installation. This equipment generates, uses and can radiate radio frequency energy and, if not installed and used in accordance with manufacturer's instructions, may cause harmful interference to radio communications. However, there is no guarantee that interference will not occur in a particular installation. If this equipment does cause harmful interference to radio or television reception, which can be determined by turning the equipment off and on, the user is encouraged to try to correct the interference by one or more of the following measures:

- Reorient or relocate the receiving antenna.
- Increase the separation between the equipment and receiver.
- Connect the equipment to an outlet on a circuit different from that to which the receiver is connected.
- Consult the dealer or an experienced radio/TV technician for help.



---

The use of shielded cables for connection of the monitor to the graphics card is required to assure compliance with FCC regulations. Changes or modifications to this unit not expressly approved by the party responsible for compliance could void the user's authority to operate this equipment.

---

## Canadian Department of Communications Statement

This digital apparatus does not exceed the Class B limits for radio noise emissions from digital apparatus set out in the Radio Interference Regulations of the Canadian Department of Communications.

**This class B digital apparatus complies with Canadian ICES-003.**

# Safety information

## Electrical safety

- To prevent electrical shock hazard, disconnect the power cable from the electrical outlet before relocating the system.
- When adding or removing devices to or from the system, ensure that the power cables for the devices are unplugged before the signal cables are connected. If possible, disconnect all power cables from the existing system before you add a device.
- Before connecting or removing signal cables from the motherboard, ensure that all power cables are unplugged.
- Seek professional assistance before using an adapter or extension cord. These devices could interrupt the grounding circuit.
- Make sure that your power supply is set to the correct voltage in your area. If you are not sure about the voltage of the electrical outlet you are using, contact your local power company.
- If the power supply is broken, do not try to fix it by yourself. Contact a qualified service technician or your retailer.

## Operation safety

- Before installing the motherboard and adding devices on it, carefully read all the manuals that came with the package.
- Before using the product, make sure all cables are correctly connected and the power cables are not damaged. If you detect any damage, contact your dealer immediately.
- To avoid short circuits, keep paper clips, screws, and staples away from connectors, slots, sockets and circuitry.
- Avoid dust, humidity, and temperature extremes. Do not place the product in any area where it may become wet.
- Place the product on a stable surface.
- If you encounter technical problems with the product, contact a qualified service technician or your retailer.

# A7V266-MX specification summary

CPU	Socket A for AMD Athlon™ XP/Athlon™/Duron processors
Chipset	VIA KM266 VIA VT8235 CE
Front Side Bus (FSB)	266/200 MHz
Memory	2 x 184-pin DDR DIMM sockets support up to maximum 2GB unbuffered PC2100/1600 non-ECC DDR SDRAM memory.
Expansion slots	3 x PCI 1 x AGP 4X (1.5V only)
IDE	2 x UltraDMA133/100/66
Graphics	Integrated VIA UniChrome™ Graphics
Audio	AD1980 6-channel AUDIO CODEC S/PDIF out interface
LAN	VIA VT6103 10/100 Mbps Ethernet PHY
Hardware monitoring	Super I/O integrated monitoring of CPU/chassis fan and MB/CPU temperature
Rear panel I/O ports	1 x Parallel 1 x Serial (COM1) 1 x PS/2 keyboard 1 x PS/2 mouse 1 x RJ45 1 x Audio I/O 1 x VGA 4 x USB 2.0
Internal connectors	1 x USB connector supports additional 2 USB 2.0 ports CPU/chassis FAN connectors Chassis intrusion connector 20-pin ATX power connector CD / AUX connectors S/PDIF out connector GAME/MIDI connector Front panel audio connector
BIOS features	2Mb Flash ROM, Award BIOS, ACPI, DMI2.0, WfM 2.0, SMBIOS 2.3, PnP features, TCAV, ASUS EZ Flash, CrashFree BIOS, ASUS C.O.P. (CPU Overheating Protection)

(continued next page)

# A7V266-MX specification summary

Industry standard	PCI 2.2, USB 2.0
Manageability	WfM 2.0, DMI 2.0, WOL/WOR by PME, chassis intrusion
Support CD contents	Device drivers ASUS PC Probe ASUS Update ASUS Screensaver Award BIOS Flash Utility Microsoft® Direct X Adobe Acrobat Reader Trend Micro™ PC-cillin 2002
Accessories	User Guide ASUS A7V266-MX support CD UltraATA cable FDD cable I/O shield
Form factor	Micro-ATX form factor: 9.6 in x 9.6 in

\* Specifications are subject to change without notice.

## About this guide

### Conventions used in this guide

To make sure that you perform certain tasks properly, take note of the following symbols used throughout this guide.



**WARNING:** Information to prevent injury to yourself when trying to complete a task.



**CAUTION:** Information to prevent damage to the components when trying to complete a task.



**IMPORTANT:** Information that you **MUST** follow to complete a task.



**NOTE:** Tips and additional information to aid in completing a task.



# *Chapter 1*

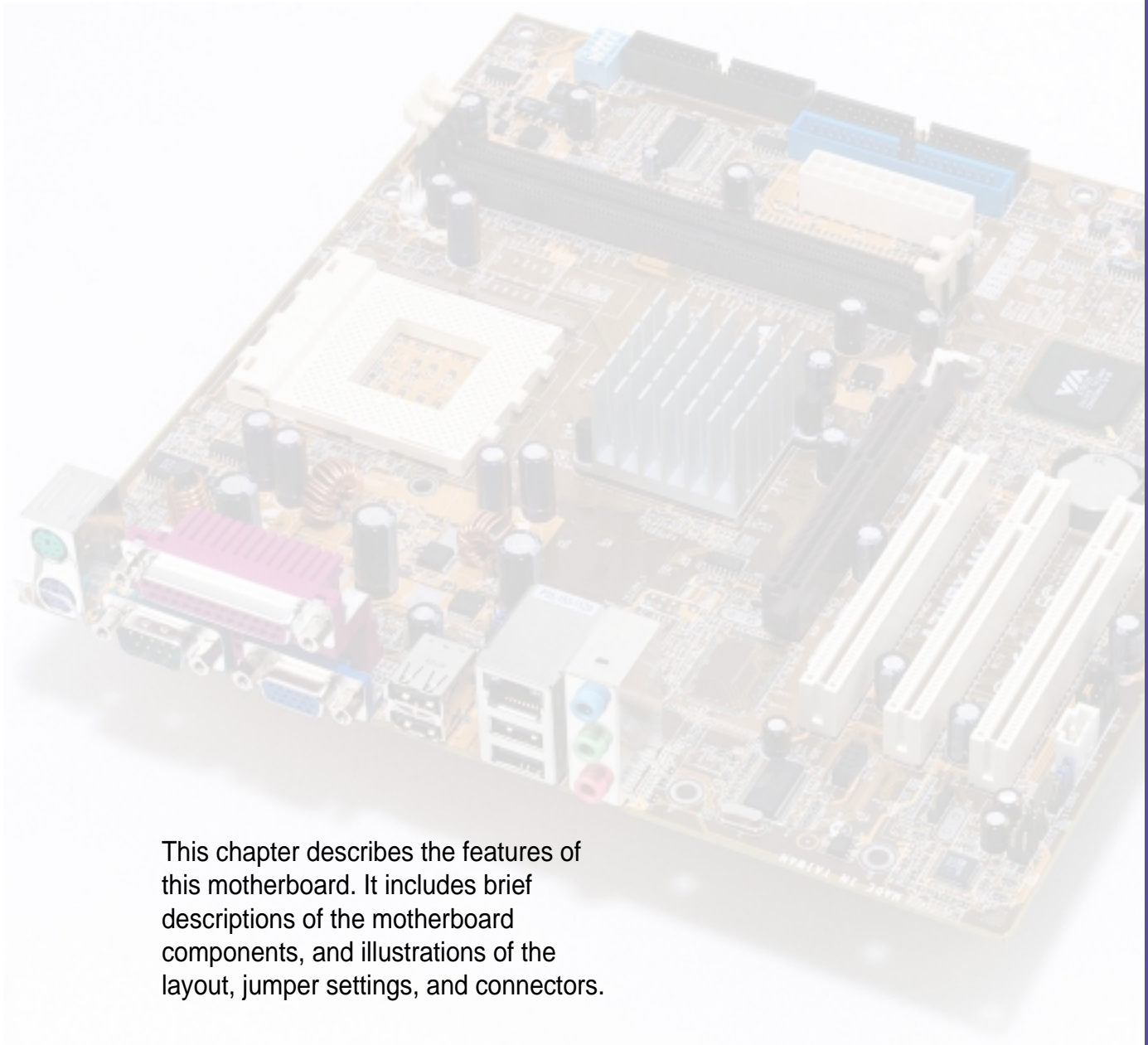

This chapter describes the features of this motherboard. It includes brief descriptions of the motherboard components, and illustrations of the layout, jumper settings, and connectors.

## **Product introduction**

# 1.1 Welcome!

**Thank you for buying the ASUS® A7V266-MX motherboard!**

The ASUS A7V266-MX motherboard is loaded with the most advanced technologies to deliver maximum performance for Socket A processors. This motherboard is packed with value-added features for guaranteed consumer satisfaction. The following sections provide important technical information about the motherboard for future upgrades or system reconfiguration.

Before you start installing the motherboard and hardware devices on it, check the items in your package with the list below.

## 1.2 Package contents

Check your ASUS A7V266-MX package for the following items.

- ✓ ASUS A7V266-MX motherboard. (Micro-ATX form factor: 9.6 in x 9.6 in)
- ✓ ASUS A7V266-MX support CD
- ✓ 40-pin 80-conductor ribbon cable for UltraDMA133 IDE drives
- ✓ Ribbon cable for a 3.5-inch floppy drive
- ✓ Bag of extra jumper caps
- ✓ I/O shield
- ✓ User Guide

## 1.3 Special features

### **266MHz FSB support for Athlon™ XP/Athlon™/Duron™ processors**

The A7V266-MX motherboard supports 266MHz front side bus frequency for Athlon™ XP/ Athlon™/Duron™ processors allowing increased application program productivity and enhanced digital media experience. See page 1-10 for details.

### **Integrated graphics**

The A7V266-MX motherboard is loaded with an integrated VIA Unichrome™ 2D/3D graphics core allowing efficient execution of multimedia applications and playback support for video and DVD.

## SoundMAX Digital Audio System



The SoundMax Digital Audio System is the industry's highest performance and most reliable audio solution for business professionals, audiophiles, musicians, and gamers. SoundMAX Digital Audio System can output 5.1 channel surround and features state-of-the-art DLS2 MIDI synthesizer with Yamaha DLSbyXG sound set, 5.1 Virtual Theater™ and supports all major game audio technologies including Microsoft DirectX™8.0, Microsoft DirectSound 3D™, A3D, MacroFX, ZoomFX, MultiDrive 5.1 and EAX.

## USB 2.0 technology



The motherboard implements the Universal Serial Bus (USB) 2.0 specification, dramatically increasing the connection speed from the 12 Mbps bandwidth on USB 1.1 to a fast 480 Mbps on USB 2.0. USB 2.0 is backward compatible with USB 1.1.

## ASUS C.O.P.



The ASUS C.O.P. (CPU Overheating Protection) is a hardware protection circuit that automatically shuts down the system power before temperatures go high enough to permanently damage the CPU.

## ASUS CrashFree BIOS



CrashFree BIOS allows users to restore BIOS data from a floppy disk even when BIOS code and data are corrupted. Users can now enjoy this feature without the need to buy a new ROM.

## Digital audio support



A Sony/Philips Digital Interface (S/PDIF) connector is onboard to give you convenient connectivity to external home theater audio systems. The S/PDIF technology allows direct digital audio transfers keeping the best signal quality. NOTE: The S/PDIF module is purchased separately.

## Integrated 10/100 LAN



The A7V266-MX motherboard is equipped with an onboard 10/100Mbps Fast Ethernet controller to give you a fast and reliable connection to Local Area Networks (LANs) and the Internet.

# 1.4 Motherboard components

Before you install the motherboard, learn about its major components and available features to facilitate the installation and future upgrades. Refer to the succeeding pages for the component descriptions.

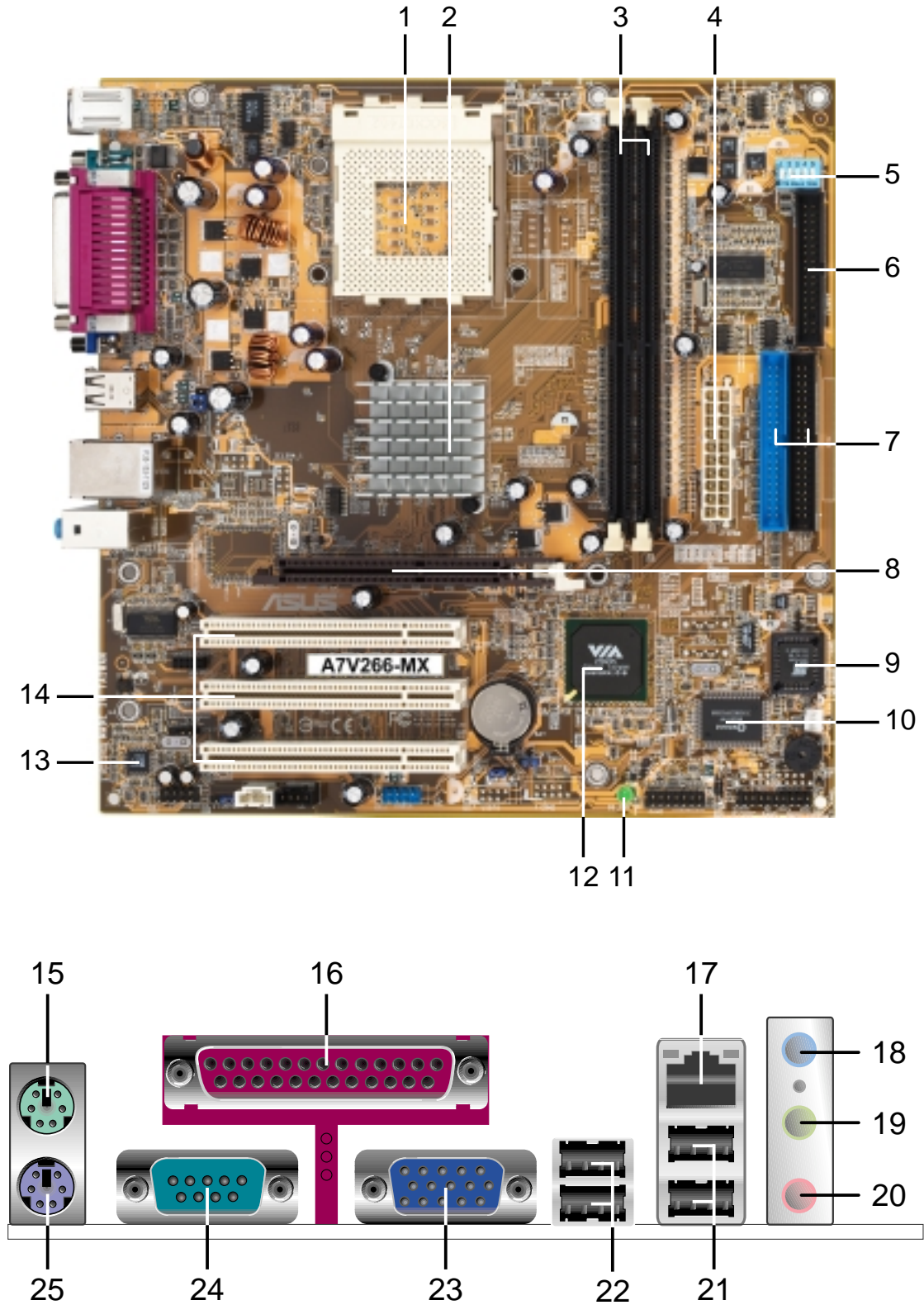

- 1 CPU socket.** Socket 462 (Socket A) Zero Insertion Force (ZIF) socket for AMD Athlon XP™/Athlon™/Duron™ processor.
- 2 Northbridge.** The VIA KM266 Northbridge controller chipset supports a 64-bit DDR memory controller and up to 2GB of 266/200MHz DDR memory. It also supports AGP 4X technology. VIA KM266 is also loaded with the VIA UniChrome™ 2D/3D graphics core for efficient multimedia applications including DVD and video playback support.
- 3 DDR DIMM sockets.** Equipped with two Double Data Rate Dual Inline Memory Module (DDR DIMM) sockets to support up to 2GB of DDR SDRAM, the newest memory standard with the highest bandwidth and lowest latency currently available. This memory technology supplies allows data transfer rates of up to 2.1GB/s on 266MHz DDR SDRAM.
- 4 ATX power connector.** This standard 20-pin connector connects to an ATX 12V power supply. The power supply must have at least 1A on the +5V standby lead (+5VSB).
- 5 DIP switches.** This 5-pin Dual Inline Package (DIP) switches allows you to select the CPU frequency multiple.
- 6 Floppy disk drive connector.** This connector connects the provided ribbon cable for the floppy disk drive. One side of the connector is slotted to prevent incorrect insertion of the floppy disk cable.
- 7 IDE connectors.** These dual-channel bus master IDE connectors support up to four UltraDMA133/100/66, PIO Modes 0-4 IDE devices. Both the primary (blue) and secondary (black) connectors are slotted to prevent incorrect insertion of the IDE ribbon cable.
- 8 AGP slot.** The Accelerated Graphics Port (AGP) slot only supports 1.5V AGP 4X mode graphics cards for 3D graphical applications.
- 9 Flash ROM.** This 2Mb ISA chip contains the programmable BIOS program.
- 10 Super I/O chip.** Winbond 83697HF I/O controller offers support for a variety of I/O functions. Provides two high-speed UART compatible serial ports and one parallel port with EPP and ECP capabilities. The Super I/O controller supports a floppy disk drive, Game/MIDI port, PS/2 keyboard, and PS/2 mouse.
- 11 Onboard LED.** This onboard LED lights up if there is a standby power on the motherboard. This LED acts as a reminder to turn off the system power before plugging or unplugging devices.



- 12 Southbridge.** The VIA VT8235 CE Southbridge controller communicates with the north bridge at rates of up to 533MB/s using the VIA 8X VLink Technology. The Southbridge controller provides efficient bandwidth requirements for PCI, USB and support for LAN devices. The controller also supports standard UltraDMA133/100/66 and provides separate data paths for each IDE channel for up to two IDE devices. The controller supports six USB ports, one LAN port and is PCI 2.2 compliant.
- 13 Audio CODEC.** The ADI AD1980 6-channel Audio CODEC is AC'97 compliant and is designed for PC multimedia systems.
- 14 PCI slots.** These 32-bit PCI 2.2 expansion slots support bus master PCI cards like SCSI and LAN cards with 133MB/s maximum output.
- 15 PS/2 mouse port.** This green 6-pin connector is for a PS/2 mouse.
- 16 Parallel port.** This 25-pin port connects a parallel printer, a scanner, or other devices.
- 17 RJ-45 port.** Using the South bridge integrated MAC and the VIA VT6103 LAN PHY Fast Ethernet controller, this port allows connection to a Local Area Network (LAN) through a network hub.
- 18 Line In jack.** This Line In (light blue) jack connects a tape player or other audio sources. In a 6-channel mode, this jack functions as Bass/Center.
- 19 Line Out jack.** This Line Out (lime) jack connects a headphone or a speaker. In a 6-channel mode, this jack functions as Front Speaker Out.
- 20 Microphone jack.** This Mic (pink) jack connects a microphone. In a 6-channel mode, this jack functions as Rear Speaker Out.
- 21 USB 1 & 2 ports.** These two 4-pin Universal Serial Bus 2.0/1.1 ports are available for connecting USB devices such as mouse and PDA.
- 22 USB 3 & 4 ports.** These two 4-pin Universal Serial Bus 2.0/1.1 ports are available for connecting USB devices such as mouse and PDA.
- 23 VGA port.** This 15-pin VGA port connects to a VGA monitor.
- 24 Serial port (COM1).** This port connects to your serial mouse and other serial devices.
- 25 PS/2 keyboard port.** This purple 6-pin connector is for a PS/2 keyboard.

# 1.5 Motherboard layout

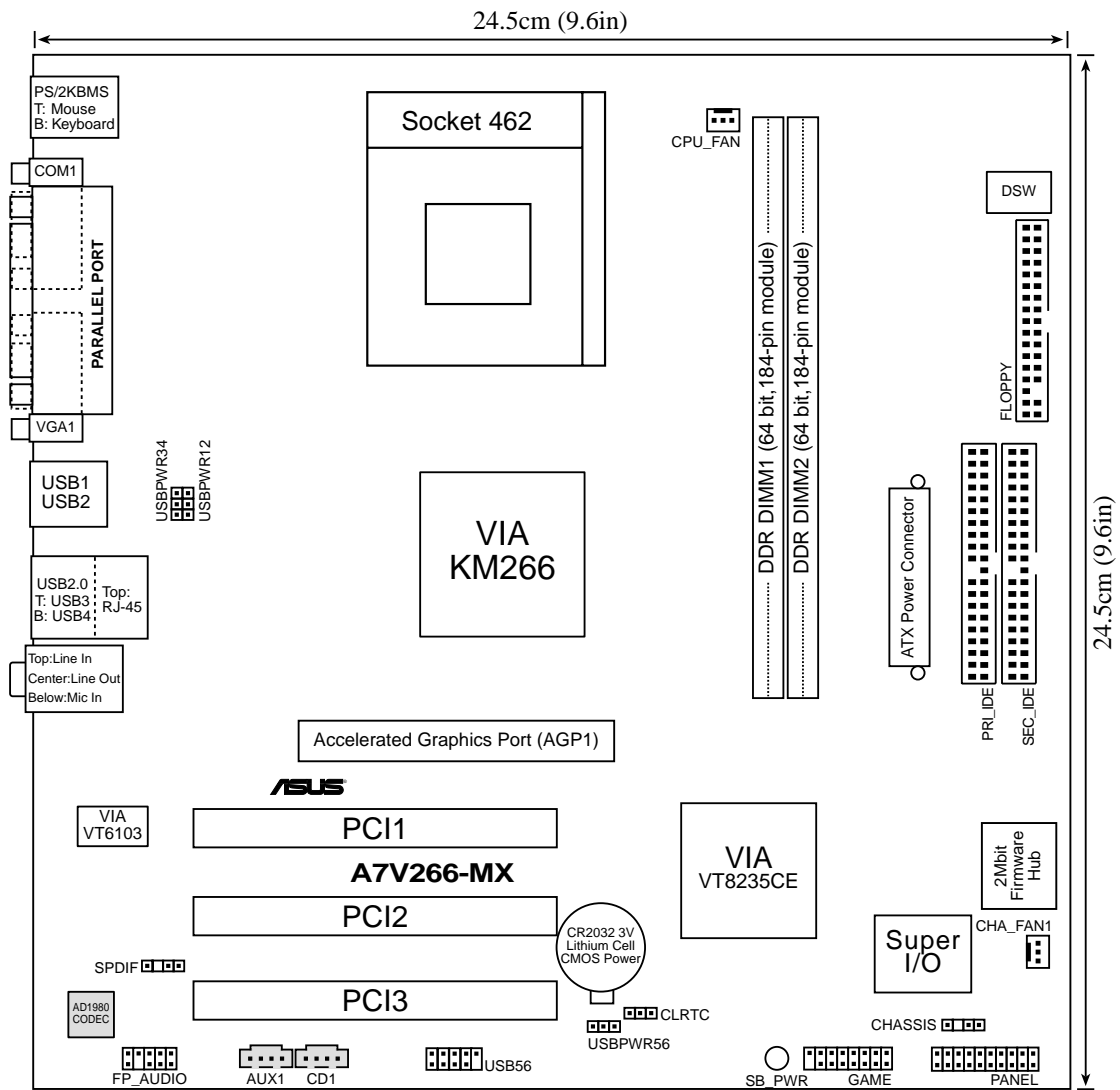

# 1.6 Motherboard installation

The A7V266-MX uses the Micro ATX form factor, measuring 24.5 cm (9.6 in.) x 24.5 cm (9.6 in.) - a standard fit for most large chassis.



Unplug the power cord before installing the motherboard. Failure to do so may cause you physical injury and damage Motherboard components.

## 1.6.1 Placement direction

Orient the motherboard with the chassis before installation. The edge with external ports goes to the rear part of the chassis. Refer to the image below. It may be more convenient to install major cables, the CPU and modular components before fixing the motherboard inside the case frame.

## 1.6.2 Screw holes

Place eight (8) screws into the holes indicated by circles to secure the motherboard to the chassis.



Do not overtighten the screws! Doing so may damage the motherboard.

Place this side  
towards the rear of  
the chassis

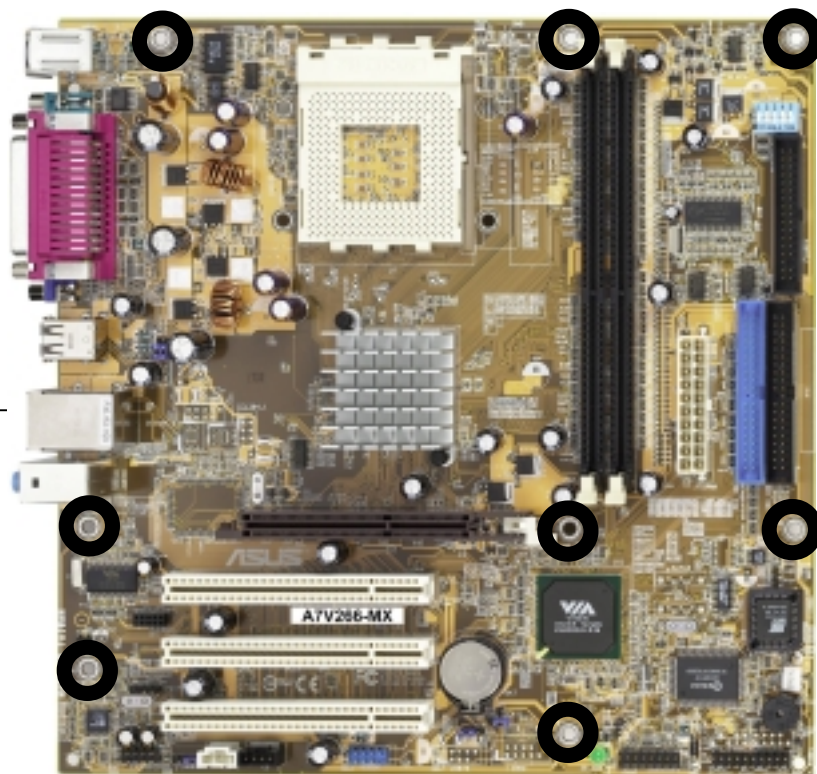



# 1.7 Before you proceed

Take note of the following precautions before you install motherboard components or change any motherboard settings.



1. Unplug the power cord from the wall socket before touching any component.
2. Use a grounded wrist strap or touch a safely grounded object or to a metal object, such as the power supply case, before handling components to avoid damaging them due to static electricity.
3. Avoid touching the ICs on components.
4. Whenever you uninstall any component, place it on a grounded antistatic pad or in the bag that came with the component.
5. **Before you install or remove any component, ensure that the ATX power supply is switched off or the power cord is detached from the power supply.** Failure to do so may cause severe damage to the motherboard, peripherals, and/or components.



When lit, the onboard LED indicates that the system is ON, in sleep mode or in soft-off mode, not powered OFF. See the illustration below.

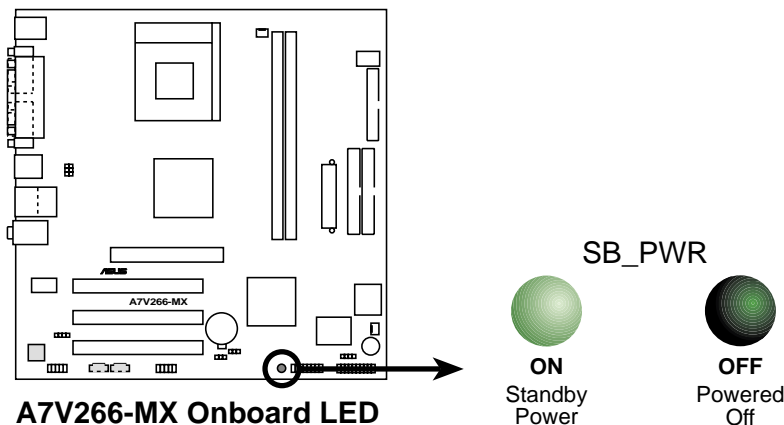

## 1.8 Central Processing Unit (CPU)

The motherboard provides a Socket A (462) for CPU installation. The A7V266-MX supports Athlon™ XP processors with “QuantiSpeed” data processing, large data caches, 3D enhancements and 266/200MHz bus speeds. AMD Athlon™ XP processors offer gigahertz speeds to support all the latest computing platforms and applications

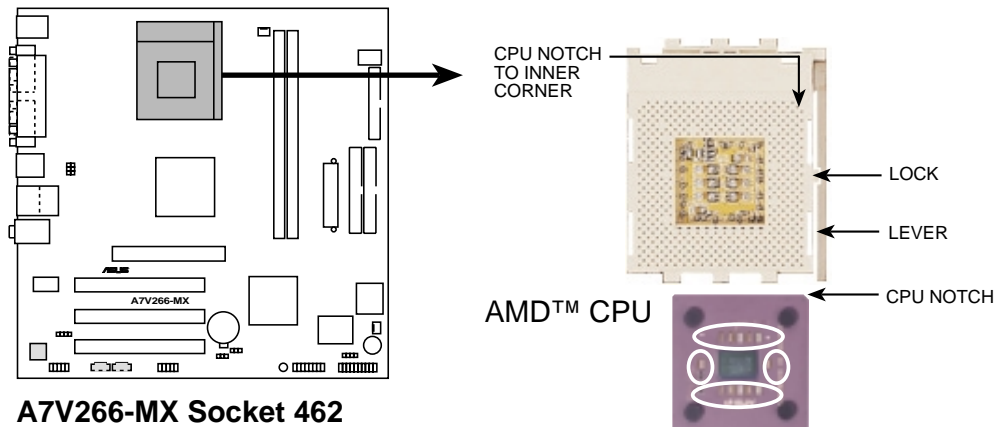

Each AMD CPU has a “marked” corner. This corner is usually indicated with a notch, and/or a golden square or triangle. Refer to this indicator while orienting the CPU. A fan and heatsink should be attached to the CPU to prevent overheating.

### Installing the CPU

Follow these steps to install a CPU:

1. Locate the Socket 462 and open it by pulling the lever gently sideways away from the socket. Then lift the lever upwards. The socket lever must be fully opened (90 to 100 degrees).
2. Insert the CPU with the correct orientation. The **notched or golden corner** of the CPU must be oriented toward the inner corner of the socket base nearest to the lever hinge.

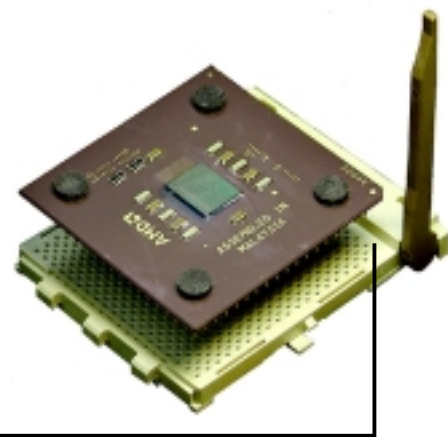

The CPU should drop easily into place. **Do not force the CPU** into the socket to avoid bending the pins. If the CPU does not fit, check its alignment and look for bent pins.

# 1.9 System memory

The motherboard has two Double Data Rate (DDR) DIMM sockets that supports up to 2GB non-ECC PC2100/1600 DDR SDRAM DIMMs. Each DIMM socket is two-sided. DIMMs come in combinations of single or double-sided types ranging through 64MB, 128MB, 256MB, 512MB and 1 GB.

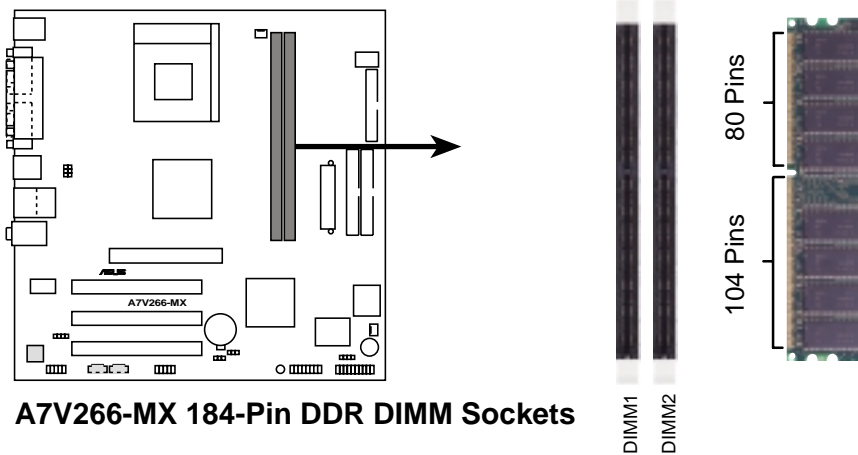

## Installing a DIMM

1. Unlock a DIMM socket by pressing the retaining clips outward.
2. Align a DIMM on the socket. Make sure the notches on the DIMM exactly match the notches in the socket.
3. Firmly insert the DIMM into the socket until the retaining clips lock into place.

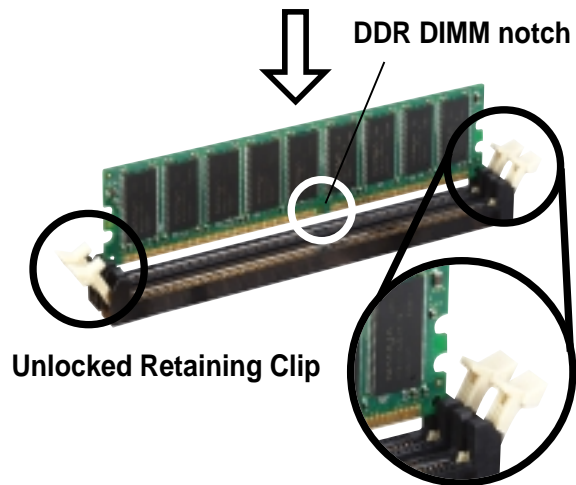

A DDR DIMM is keyed with a notch so that it fits in only one direction. DO NOT force a DIMM into a socket to avoid damaging the DIMM.

# 1.10 Expansion slots

The A7V266-MX motherboard has three (3) PCI and one (1) Accelerated Graphics Port (AGP). The following sub-sections describe the slots and the expansion cards that they support.

## 1.10.1 Configuring an expansion card

Some expansion cards need an IRQ to operate. Generally, an IRQ must be exclusively assigned to one function at a time. In a standard design configuration, 16 IRQs are available but most are already in use.

Normally, 6 IRQs are free for expansion cards. Sometimes IRQs are “shared” by more than one function; in this case, IRQ assignments are swapped automatically or adjusted through the BIOS firmware.

### Standard Interrupt Assignments

IRQ	Standard Function
0	System Timer
1	Keyboard Controller
2	Programmable Interrupt Controller
3*	USB Universal Host Controller
4*	Communications Port (COM1)
5*	Onboard Audio
6	Standard Floppy Disk Controller
7*	Printer Port (LPT1)
8	System CMOS/Real Time Clock
9*	Onboard LAN
10*	USB Universal Host Controller
11*	Onboard VGA
12*	PS/2 Compatible Mouse Port
13	Numeric Data Processor
14*	Ultra ATA Controller
15*	Secondary Ultra ATA Controller

*\* These IRQs are usually available for ISA or PCI devices.*

### IRQ assignments for this motherboard

	A	B	C	D
PCI slot 1	shared	-	-	-
PCI slot 2	-	shared	-	-
PCI slot 3	-	-	shared	-
AGP slot	shared	-	-	-

## 1.10.2 AGP slot

This motherboard has an Accelerated Graphics Port (AGP) slot that supports +1.5V AGP 4X cards. Note the notches on the card golden fingers to ensure that they fit the AGP slot on your motherboard.

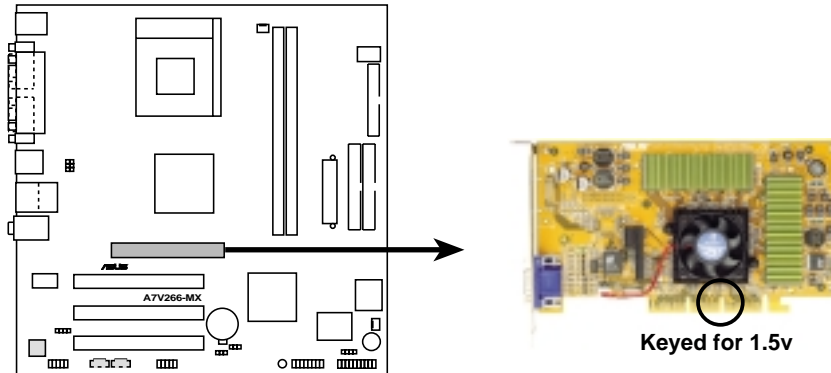

**A7V266-MX Accelerated Graphics Port (AGP)**

## 1.10.3 PCI slots

Three 32-bit PCI slots are available on this motherboard. The slots support PCI cards such as LAN card, SCSI card, USB card, and other cards that comply with PCI specifications. This figure shows a typical PCI card installed into a slot:

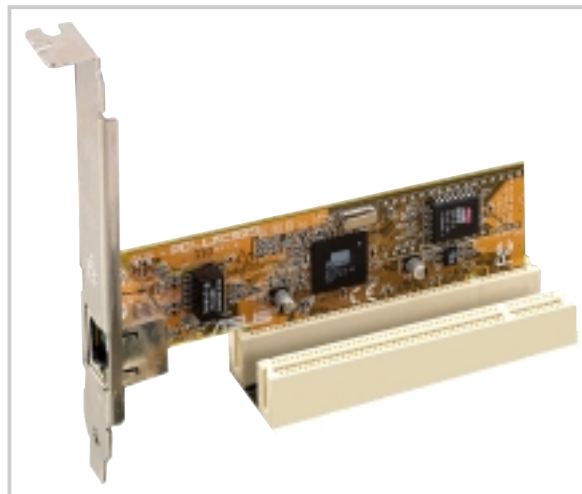

## 1.11 Switch and jumpers

The motherboard frequency is adjusted through the DIP switches. The white block represents the switch position. The illustration below shows the ON and OFF positions of the switches.

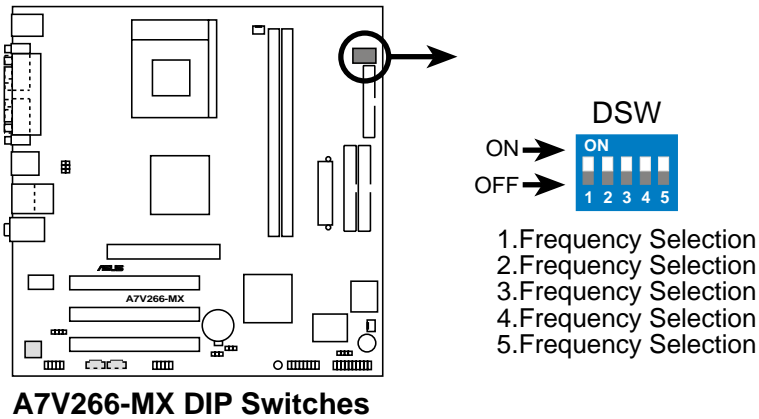

The option to set the CPU core bus frequency multiple is available only on unlocked CPUs. If you are using a locked CPU, setting the switches does not produce any effect.

### 1. CPU external frequency selection (SW1 Switches 1-5)

This option tells the clock generator what frequency to send the CPU. This allows the selection of the CPU's external frequency (or Bus Clock). The BUS Clock multiplied by the Frequency Multiple equals the CPU's internal frequency (the advertised CPU speed).

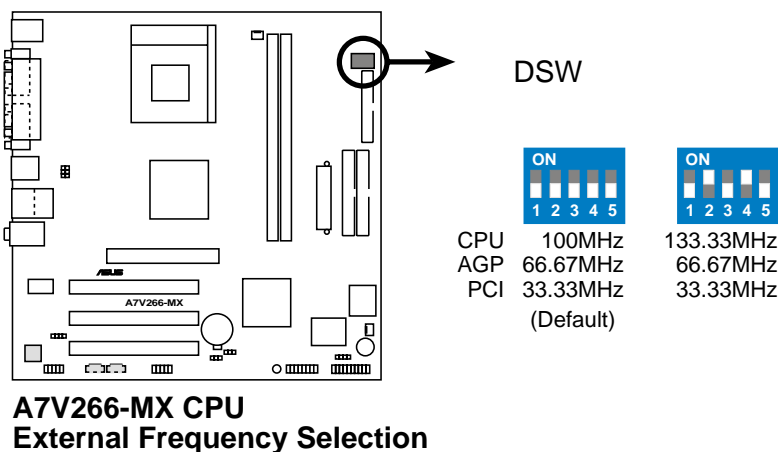

The default CPU external frequency is 100MHz. If your CPU supports 133MHz external frequency, adjust the DSW settings before installing the motherboard.



Set the CPU frequency only to the recommended settings. Frequencies other than the recommended CPU bus frequencies are not guaranteed to be stable.

## 2. USB device wake-up (3-pin USBPWR12, USBPWR34, USBPWR56)

Set these jumpers to +5V to wake up the computer from S1 sleep mode (CPU stopped, DRAM refreshed, system running in low power mode) using the connected USB devices. Set to +5VSB to wake up from S3 sleep mode (no power to CPU, DRAM in slow refresh, power supply in reduced power mode). Both jumpers are set to pins 1-2 (+5V) by default because not all computers have the appropriate power supply to support this feature.

The USBPWR12 and USBPWR34 jumpers are for rear USB ports. USBPWR56 is for the internal USB header that you can connect to front USB ports.



The USB device wake-up feature requires a power supply that can provide 500mA on the +5VSB lead for each USB port. Otherwise, the system does not power up.

The total current consumed must NOT exceed the power supply capability (+5VSB) whether under normal condition or in sleep mode.

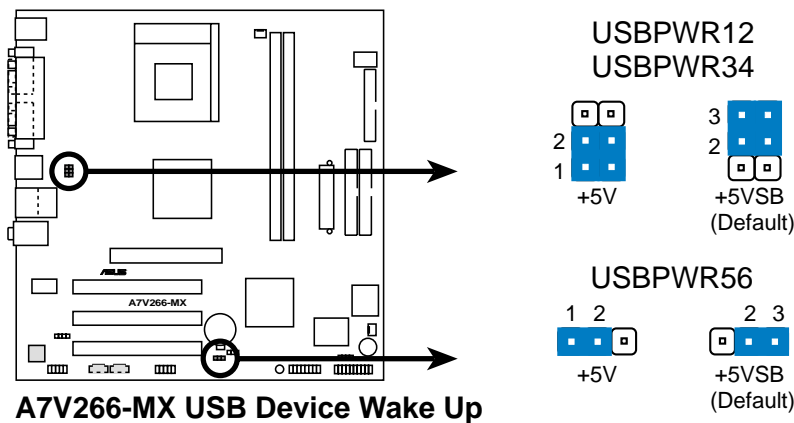

### 3. Clear RTC RAM (CLRRTC)

This jumper clears the Real Time Clock (RTC) RAM of date, time and system setup parameters in CMOS. The RAM data in CMOS is powered by the onboard button cell battery.

To erase the RTC RAM:

1. Turn OFF the computer and unplug the power cord.
2. Remove the battery.
3. Move the jumper caps from [2-3] to [1-2] momentarily. Replace the jumper cap to the original position, [2-3].
4. Re-install the battery.
5. Plug the power cord and turn ON the computer.
6. Hold down the <Del> key during the boot process and enter BIOS setup to re-enter data.

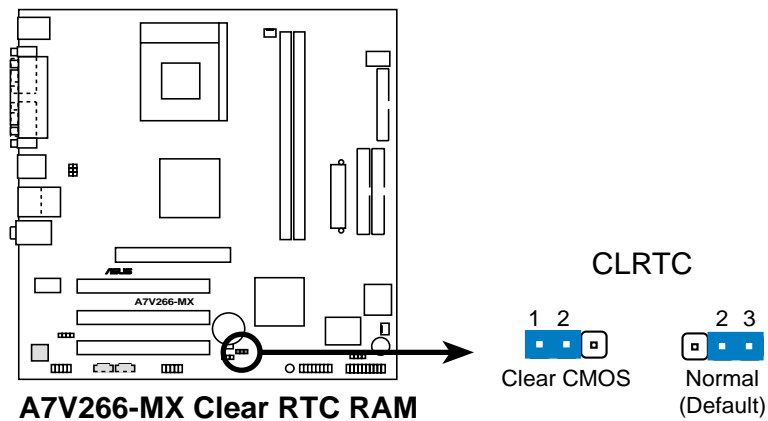



## 1.12 Connectors

This section describes and illustrates the connectors on the motherboard.

### 1. IDE connectors (40-1 pin PRI\_IDE, SEC\_IDE)

This connector supports the provided UltraDMA IDE hard disk ribbon cable. Connect the cable's blue connector to the primary (recommended) or secondary IDE connector, then connect the gray connector to the UltraDMA133 slave device (hard disk drive) and the black connector to the UltraDMA133 master device.



Pin 20 on each IDE connector is removed to match the covered hole on the UltraDMA cable connector. This prevents incorrect orientation when you connect the cables.

For UltraDMA133 IDE devices, use 40-pin 80-conductor cable.

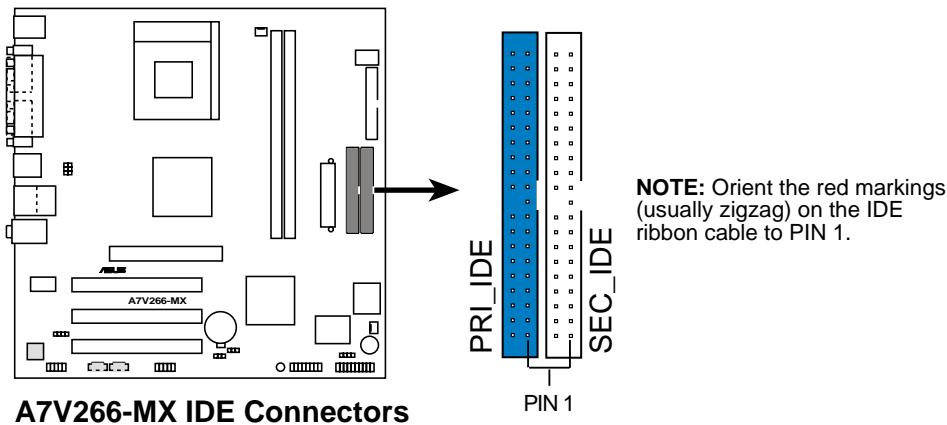

### 2. Floppy disk drive connector (34-1 pin FLOPPY1)

This connector supports the provided floppy drive ribbon cable. After connecting one end to the motherboard, connect the other end to the floppy drive. (Pin 5 is removed to prevent incorrect insertion when using ribbon cables with pin 5 plug.)

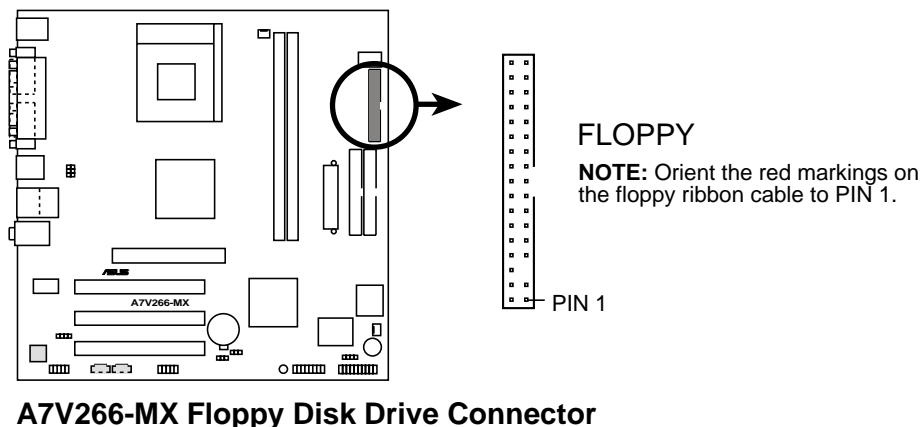

### 3. Digital Audio Connector (6-1 pin SPDIF)

This connector is for optional S/PDIF audio module that allows digital instead of analog sound input and output.

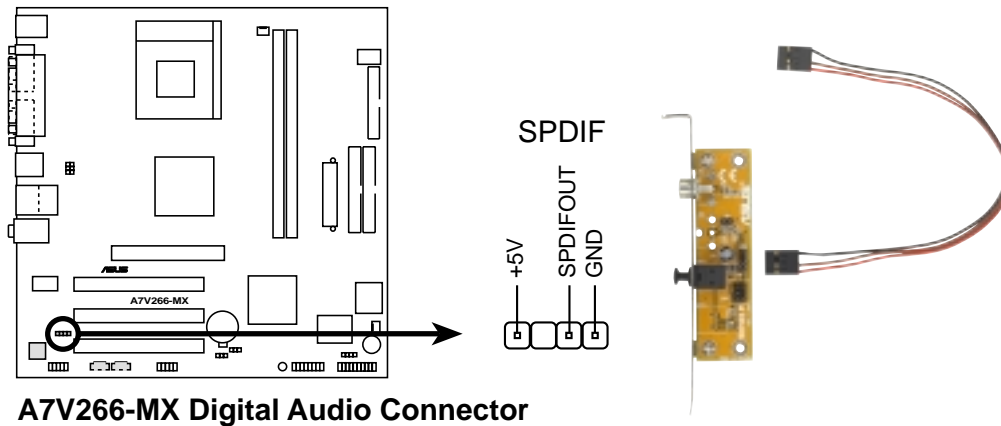

When you input sound for S/PDIF IN, the LINE\_OUT will output the sound. Mute LINE\_OUT to impede sound output from S/PDIF IN. The S/PDIF module is not included in this motherboard package.

### 4. ATX power connectors (20-pin ATXPWR)

These connectors connect to an ATX 12V power supply. The plugs from the power supply are designed to fit these connectors in only one orientation. Find the proper orientation and push down firmly until the connectors completely fit.

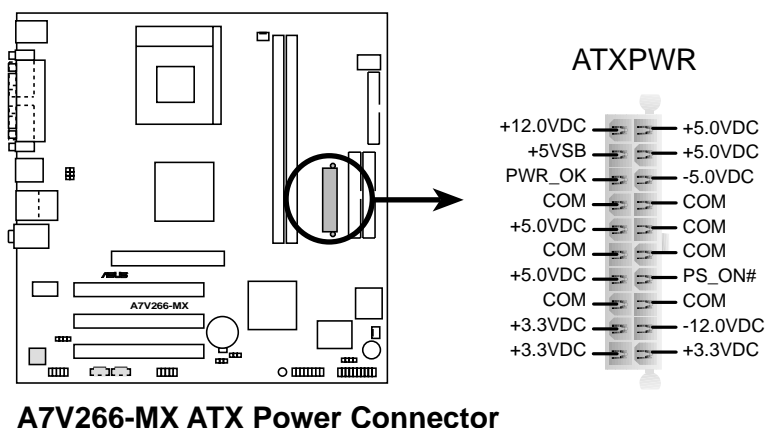

If you will need to replace the power supply in the future, make sure that your new ATX 12V power supply can provide 8A on the +12V lead and at least 1A on the +5-volt standby lead (+5VSB). The minimum recommended wattage is 230W, or 300W for a fully configured system. The system may become unstable and may experience difficulty powering up if the power supply is inadequate.

## 5. USB header (10-1 pin USB56)

If the USB 2.0 port connectors on the back panel are inadequate, a USB header is available for two additional USB port connectors. Connect a 2-port USB connector set to a USB header and mount the USB bracket to an open slot in the chassis.

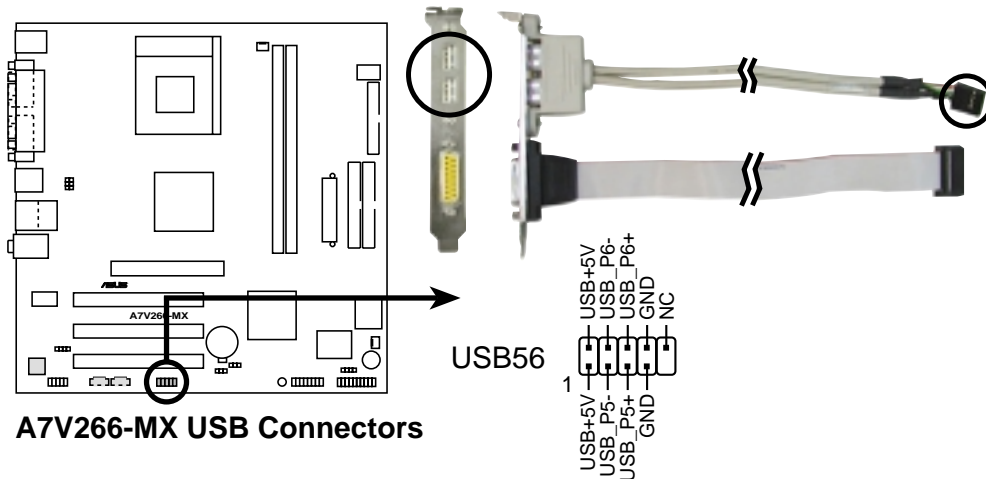

**A7V266-MX USB Connectors**



The USB connector module is not included in this motherboard package.

## 6. GAME/MIDI connector (16-1 pin GAME)

This connector supports a GAME/MIDI module. If your package came with the optional USB 2.0/GAME module, connect the GAME/MIDI cable to this connector. The GAME/MIDI port on the module connects a joystick or a game pad for playing games, and MIDI devices for playing or editing audio files.

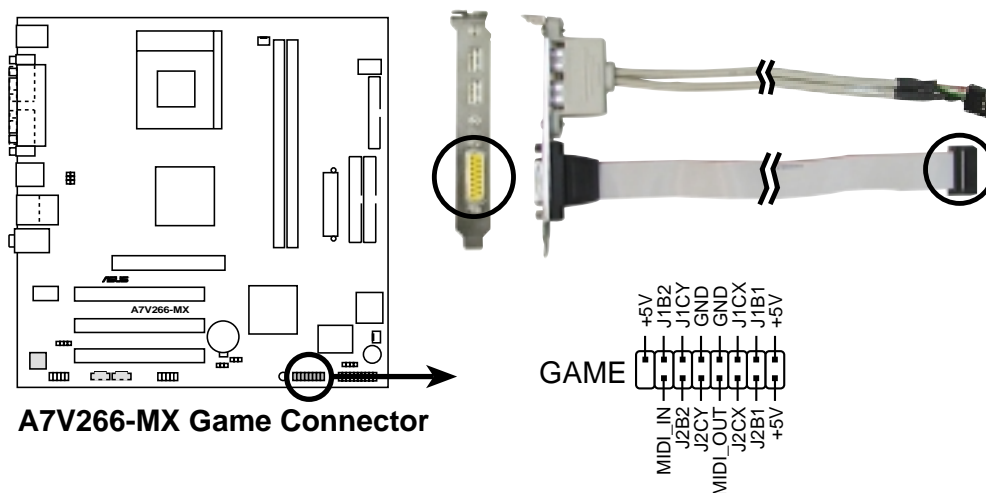

**A7V266-MX Game Connector**



The GAME port module is not included in this motherboard package.

## 7. CPU and Chassis Fan Connectors (3-pin CPU\_FAN, CHA\_FAN)

The fan connectors support cooling fans of 350mA~740mA (8.88W max). Connect the fan cables to the fan connectors on the motherboard, making sure that the black wire of each cable matches the ground pin of the connector.

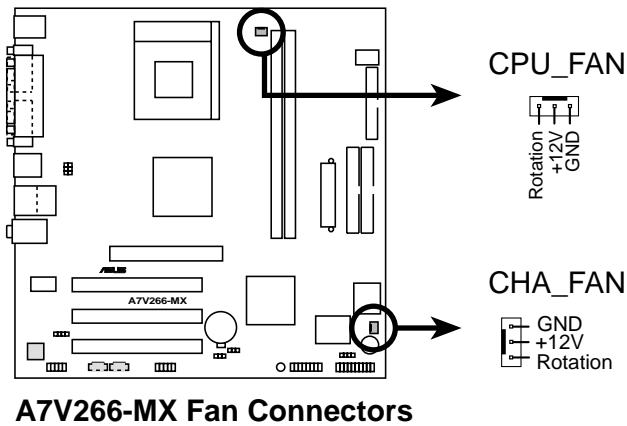

Do not forget to connect the fan cables to the fan connectors. Lack of sufficient air flow within the system may damage the motherboard components. These are not jumpers! DO NOT place jumper caps on the fan connectors!

## 8. Chassis intrusion connector (4-1 pin CHASSIS)

This lead is for a chassis designed with intrusion detection feature. This requires an external detection mechanism such as a chassis intrusion sensor or microswitch. When you remove any chassis component, the sensor triggers and sends a high-level signal to this lead to record a chassis intrusion event.

By default, the pins labeled “Chassis Signal” and “Ground” are shorted with a jumper cap. If you wish to use the chassis intrusion detection feature, remove the jumper cap from the pins.

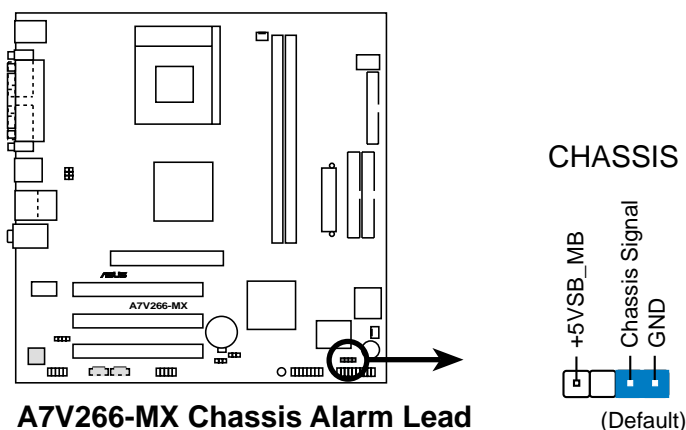

## 9. Front panel audio connectors (10-1 pin FP\_AUDIO)

This is an interface for front panel audio cable that allows convenient connection and control of audio devices.

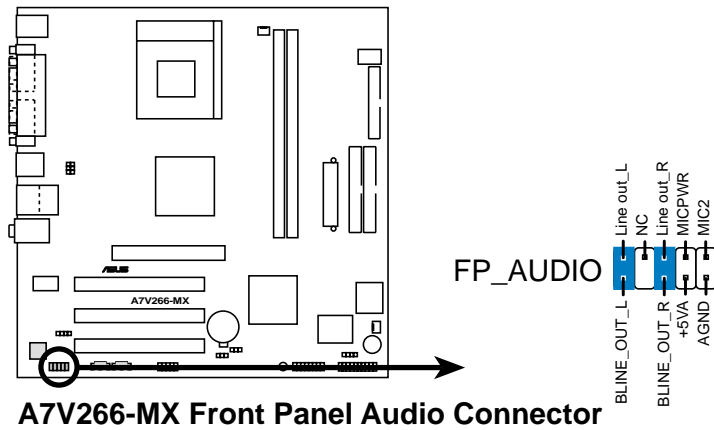

## 10. Internal audio connectors (4 pin CD, AUX)

These connectors allow you to receive stereo audio input from sound sources such as a CD-ROM, TV tuner, MPEG card or modem.

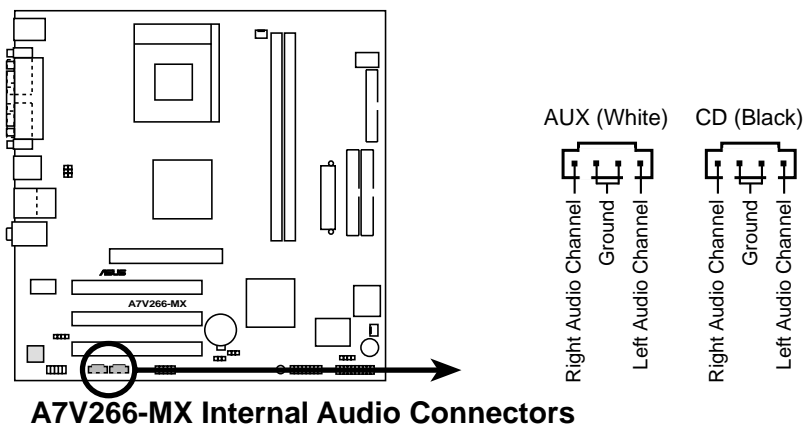

## 11. System panel connector (20-pin PANEL)

This connector accommodates several system front panel functions.

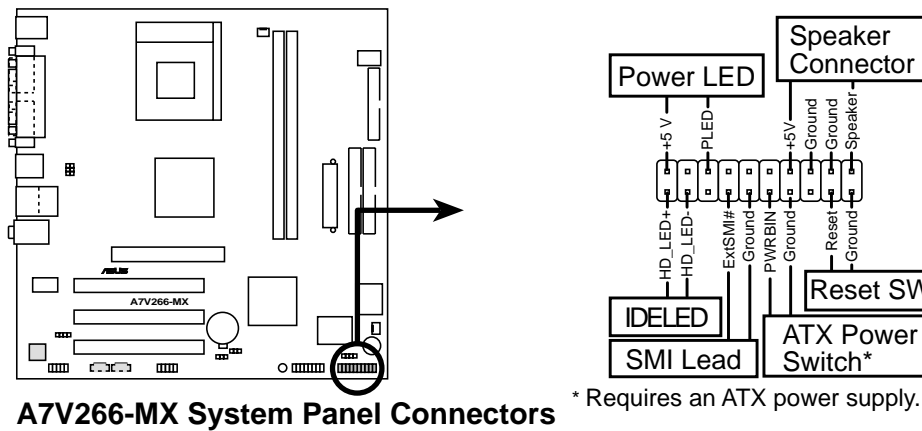

- **System Power LED Lead (3-1 pin PLED)**

This 3-1 pin connector connects to the system power LED. The LED lights up when you turn on the system power, and blinks when the system is in sleep mode.

- **System Warning Speaker Lead (4-pin SPEAKER)**

This 4-pin connector connects to the case-mounted speaker and allows you to hear system beeps and warnings.

- **System Management Interrupt Lead (2-pin SMI)**

This 2-pin connector allows you to manually place the system into a suspend mode, or “green” mode, where system activity is instantly decreased to save power and to expand the life of certain system components. Attach the case-mounted suspend switch to this 2-pin connector.

- **Reset Switch (2-pin RESET)**

This 2-pin connector connects to the case-mounted reset switch for rebooting the system without turning off the power switch.

- **ATX Power Switch/Soft-Off Switch Lead (2-pin PWR)**

This connector connects a switch that controls the system power. Pressing the power switch turns the system between ON and SLEEP, or ON and SOFT OFF, depending on the BIOS or OS settings. Pressing the power switch while in the ON mode for more than 4 seconds turns the system OFF.

- **Hard Disk Activity Lead (2-pin IDE LED)**

This connector supplies power to the hard disk activity LED. The read or write activities of any device connected to the primary or secondary IDE connector cause this LED to light up.

# ***Chapter 2***

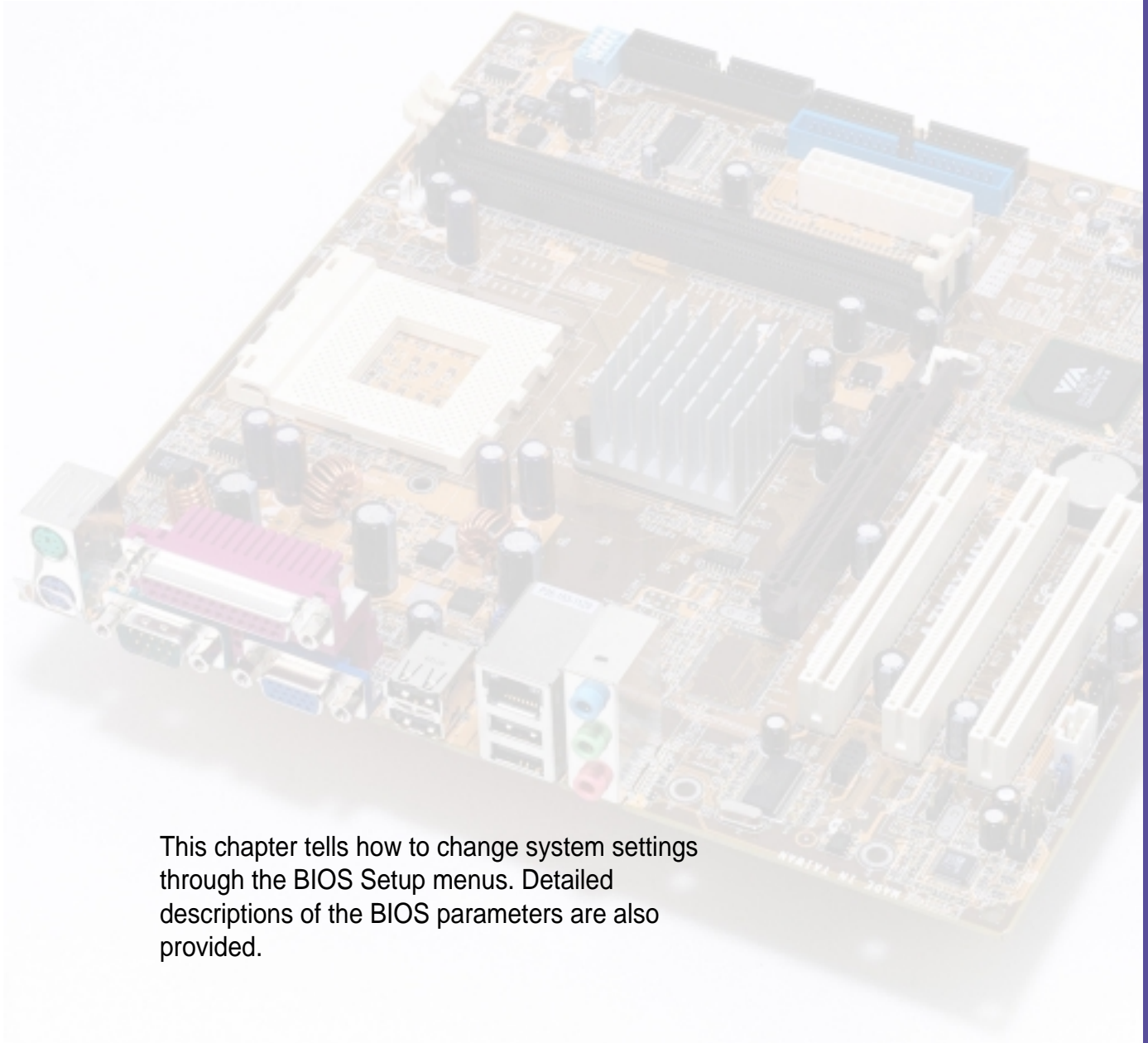

This chapter tells how to change system settings through the BIOS Setup menus. Detailed descriptions of the BIOS parameters are also provided.

## **BIOS information**

## 2.1 Managing and updating your BIOS



- 
- The **original BIOS file** for this motherboard is in the support CD.
  - Copy the original BIOS to a **bootable floppy disk** in case you need to restore the BIOS in the future.
- 

### 2.1.1 Creating a bootable floppy disk

1. Do either one of the following to create a bootable floppy disk.

#### DOS environment

Insert a 1.44 MB floppy disk into the drive. At the DOS prompt, type:

**format a: /s** , then press the <Enter> key

#### Windows® 98SE environment

- a. From your Windows desktop, click **Start**, point to **Settings**, then click **Control Panel**.
- b. Double-click **Add/Remove Programs** icon from the Control Panel window.
- c. Click on the **Startup Disk** tab, then on **Create Disk...** button.
- d. Insert a 1.44 MB floppy disk when prompted. Follow the succeeding screen instructions to complete the process.

#### Windows® XP environment

- a. Insert a new 1.44 MB floppy disk in the floppy disk drive.
  - b. From the Windows desktop, click **Start > My Computer**.
  - c. In the **My Computer** window, click the **3 1/2 Floppy** icon.
  - d. From the Menu bar, click **File > Format**.
  - e. Select “**Create an MS-DOS Startup Disk**” in the **Format Options** field, then click **Start**.
2. Copy the original (or the latest) motherboard BIOS to the bootable floppy disk.



## 2.1.2 Updating BIOS using the AwardBIOS Flash Utility

The Basic Input/Output System (BIOS) can be updated using the built-in Flash Memory Writer utility or using a bootable floppy disk with the executable Flash Memory Writer Utility (AWDFLASH.EXE). Follow these instructions to update the BIOS using this utility.

1. Download the latest BIOS file from the ASUS website (see ASUS contact info on page vi). Rename the file to \*.BIN and save it to a floppy disk.



---

Save only the updated BIOS file in the floppy disk to avoid loading a wrong BIOS file.

---

2. Insert the disk that contains the new BIOS file into the floppy drive.
3. Reboot the computer.
4. Press <Alt> + <F2> during POST to display the following screen.



```
AwardBIOS Flash Utility V8.24B
(C)Phoenix Technologies Ltd. All Rights Reserved

For KM266-8235-6A6LYA0AC-00  DATE: 05/19/2003
Flash Type - SST-39SF020 /5V
File Name to Program : aw0702.bin

Message: Please Wait!
```

5. AWDFLASH checks the new BIOS file from the floppy disk.
6. After verification, AWDFLASH flashes the new BIOS file. Do not shut down the computer during the flash process.

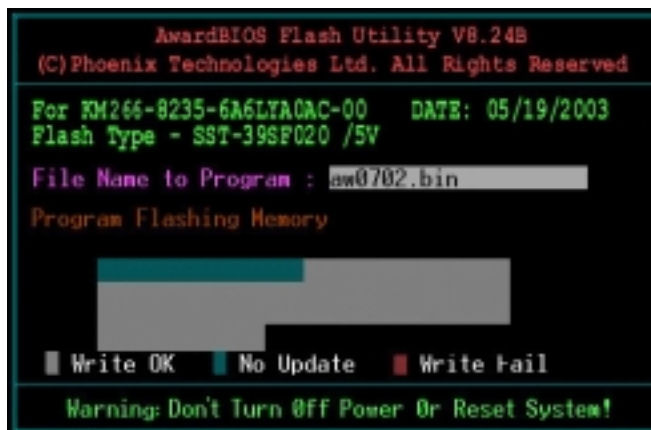

```
AwardBIOS Flash Utility V8.24B
(C)Phoenix Technologies Ltd. All Rights Reserved

For KM266-8235-6A6LYA0AC-00  DATE: 05/19/2003
Flash Type - SST-39SF020 /5V
File Name to Program : aw0702.bin
Program Flashing Memory

█ Write OK  █ No Update  █ Write Fail

Warning: Don't Turn OFF Power Or Reset System!
```

7. After the new BIOS file is copied, the computer returns to POST.

## ***Updating BIOS via a bootable floppy disk***

1. Boot from the floppy disk.
2. At the "A:\>" prompt, type "C:\>" and then press <Enter>.
3. At the "C:\>" prompt, type "AWDFLASH/ BIOSFILENAME" and then <Enter>. For example: "AWDFLASH/ aw0702.bin" The AWDFLASH screen appears.
4. Follow steps 5 to 7 in "2.1.2 Updating BIOS using the Built-in Award BIOS Flash Utility."

### **2.1.3 CrashFree BIOS feature**

The CrashFree BIOS feature allows you to boot the computer from a floppy disk and update the BIOS in case the original BIOS fails or gets corrupted.



- 
1. You must have a bootable floppy disk ready before updating the BIOS.
  2. The bootable floppy disk could be the one that you created following the procedure in section 2.1.1, and should contain the AWDFLASH.EXE utility.
  3. If the BIOS fails (ROM data or codes are corrupted), a message appears during POST indicating the failure.
- 

To update the BIOS:

1. Turn on the computer, and when prompted, place the bootable floppy disk into the floppy drive, so that the computer boots from the floppy disk.
2. Follow the BIOS update procedure in section "2.1.2 Updating BIOS using the AwardBIOS Flash Utility."



---

To use the CrashFree BIOS feature on this motherboard, install a VGA card into one of the expansion slots before rebooting the computer. On motherboards with onboard VGA, such as the A7V8X-MX, you will not see the screen display when the BIOS crashes even if you reboot the computer.

---

## 2.2 BIOS beep codes

When you turn the power on and the system runs POST (Power On Self Tests), you will hear BIOS beeps. Refer to the following table for the meaning of the beeps.

### Award BIOS Beep Codes

Beep	Meaning
One short beep when displaying logo	No error during POST
Long beeps in an endless loop	No DRAM installed or detected
One long beep followed by three short beeps	Video card not found or video card memory bad
High frequency beeps when system is working	CPU overheated; System running at a lower frequency

## 2.3 BIOS Setup program

This motherboard supports a programmable FLASH ROM that you can update using the provided utility described in section “2.1 Managing and updating your BIOS.”

Use the BIOS Setup program when you are installing a motherboard, reconfiguring your system, or prompted to “Run Setup”. This section explains how to configure your system using this utility.

Even if you are not prompted to use the Setup program, you may want to change the configuration of your computer in the future. For example, you may want to enable the security password feature or make changes to the power management settings. This requires you to reconfigure your system using the BIOS Setup program so that the computer can recognize these changes and record them in the CMOS RAM of the FLASH ROM.

The FLASH ROM on the motherboard stores the Setup utility. When you start up the computer, the system provides you with the opportunity to run this program. Press <Delete> during the Power-On Self Test (POST) to enter the Setup utility, otherwise, POST continues with its test routines.

If you wish to enter Setup after POST, restart the system by pressing <Ctrl> + <Alt> + <Delete>, or by pressing the reset button on the system chassis. You can also restart by turning the system off and then back on. Do this last option only if the first two failed.

The Setup program is designed to make it as easy to use as possible. It is a menu-driven program, which means you can scroll through the various sub-menus and make your selections among the predetermined choices.



---

Because the BIOS software is constantly being updated, the following BIOS setup screens and descriptions are for reference purposes only, and may not exactly match what you see on your screen.

---

## 2.3.1 BIOS menu bar

The top of the screen has a menu bar with the following selections:

<b>MAIN</b>	Use this menu to make changes to the basic system configuration.
<b>ADVANCED</b>	Use this menu to enable and make changes to the advanced features.
<b>POWER</b>	Use this menu to configure and enable Power Management features.
<b>BOOT</b>	Use this menu to configure the default system device used to locate and load the Operating System.
<b>EXIT</b>	Use this menu to exit the current menu or to exit the Setup program.

To access the menu bar items, press the right or left arrow key on the keyboard until the desired item is highlighted.

## 2.3.2 Legend bar

At the bottom of the Setup screen is a legend bar. The keys in the legend bar allow you to navigate through the various setup menus. The following table lists the keys found in the legend bar with their corresponding functions.

<b>Navigation Key(s)</b>	<b>Function Description</b>
<F1>	Displays the General Help screen
<F2>	Navigates the Item Help screen
<F5>	Loads previous values
<F6>	Loads fail-safe default values
<F7>	Loads optimized values
<Esc>	Jumps to the Exit menu or returns to the main menu from a sub-menu
Left or Right arrow	Selects the menu item to the left or right
Up or Down arrow	Moves the highlight up or down between fields
Page Down or – (minus)	Scrolls backward through the values for the highlighted field
Page Up or + (plus)	Scrolls forward through the values for the highlighted field
<Enter>	Brings up a selection menu for the highlighted field
<F10>	Saves changes and exit

## General help

In addition to the Item Help window, the BIOS setup program also provides a General Help screen. You may launch this screen from any menu by simply pressing <F1>. The General Help screen lists the legend keys and their corresponding functions.

## Saving changes and exiting the Setup program

See “2.8 Exit Menu” for detailed information on saving changes and exiting the setup program.

## Scroll bar

When a scroll bar appears to the right of a help window, it indicates that there is more information to be displayed that will not fit in the window. Use <PgUp> and <PgDn> or the up and down arrow keys to scroll through the entire help document. Press <Home> to display the first page, press <End> to go to the last page. To exit the help window, press <Enter> or <Esc>.

## Sub-menu

The right pointer symbol that appears at the left of certain parameters indicates that a sub-menu exists for this field. A sub-menu offers additional parameter options. To display a sub-menu, move the highlight to the field and press <Enter>. The sub-menu appears. Use the legend keys to navigate and enter values within each sub-menu as you would within a menu. Use the <Esc> key to return to the main menu. Take some time to familiarize yourself with the legend keys and their corresponding functions. Practice navigating through the various menus and sub-menus. While moving around through the Setup program, note that explanations appear in the **Item Help** window located to the right of each menu. This window displays the help text for the highlighted field.

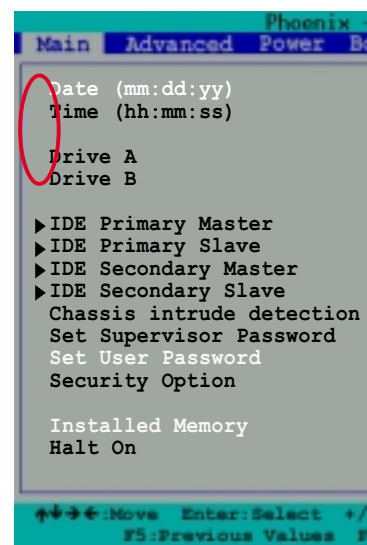

## 2.4 Main Menu

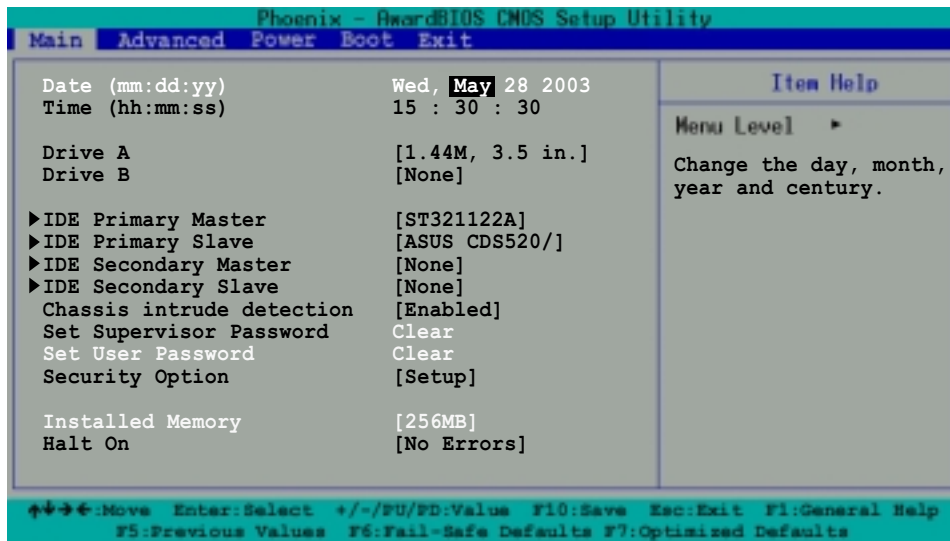

### Date [mm/dd/yy]

Sets the system to the date that you specify (usually the current date). The format is month, day, year. Valid values for month, day, and year are Month: (1 to 12), Day: (1 to 31), Year: (1999 to 2099). Use the <Tab> key to move between the month, day, and year fields.

### Time [hh:mm:ss]

Sets the system to the time that you specify (usually the current time). The format is hour, minute, second. Valid values for hour, minute and second are Hour: (00 to 23), Minute: (00 to 59), Second: (00 to 59). Use the <Tab> key to move between the hour, minute, and second fields.

### Drive A [1.44M, 3.5 in.]

Sets the type of floppy drive installed. Configuration options: [None] [360K, 5.25 in.] [1.2M , 5.25 in.] [720K , 3.5 in.] [1.44M, 3.5 in.] [2.88M, 3.5 in.]

### Drive B [None]

Sets the type of floppy drive installed. Configuration options: [None] [360K, 5.25 in.] [1.2M , 5.25 in.] [720K , 3.5 in.] [1.44M, 3.5 in.] [2.88M, 3.5 in.]

### Chassis intrude detection [Enabled]

Enable this option to activate the chassis intrusion feature of the motherboard. Configuration options: [Enabled] [Disabled]

## **Set Supervisor Password [Clear] / Set User Password [Clear]**

These fields allow you to set passwords. To set a password, highlight the appropriate field and press <Enter>. Type in a password then press <Enter>. You can type up to eight alphanumeric characters. Symbols and other characters are ignored. To confirm the password, type the password again and press <Enter>. The password is now set to [Set]. This password allows full access to the BIOS Setup menus. To clear the password, highlight this field and press <Enter>. When the same dialog box appear, press <Enter>. The password is set to [Clear].

### **A note about passwords**

The BIOS Setup program allows you to specify passwords in the Main menu. The passwords control access to the BIOS during system startup. Passwords are not case sensitive, meaning, passwords typed in either uppercase or lowercase letters are accepted. The BIOS Setup program allows you to specify two different passwords: a Supervisor password and a User password. If you did not set a Supervisor password, anyone can access the BIOS Setup program. If you did, the Supervisor password is required to enter the BIOS Setup program and to gain full access to the configuration fields.

### **Forgot the password?**

If you forget your password, you can clear it by erasing the CMOS Real Time Clock (RTC) RAM. The RAM data containing the password information is powered by the onboard button cell battery. If you need to erase the CMOS RAM, unplug the all the power cables and remove the button cell battery. Re-install the battery after about 2 seconds, then power up the system. Refer to section "1.11 Switch and Jumpers" on how to erase the CMOS RTC RAM.

## **Security Option [Setup]**

This field requires users to enter the password before entering the BIOS setup or the system. Select [Setup] to require the password before entering the BIOS Setup. Select [System] to require the password before entering the system. Configuration options: [Setup] [System]

## **Installed Memory [XXX MB]**

This field automatically displays the amount of conventional memory detected by the system during the boot process.

## **Halt On [No Errors]**

This field sets the system to halt on errors according to the system functions specified in each option. Configuration options: [All Errors] [No Errors] [All, But Keyboard] [All , But Diskette] [All, But Disk/Key]



## 2.4.1 IDE Primary Master/Slave IDE Secondary Master/Slave

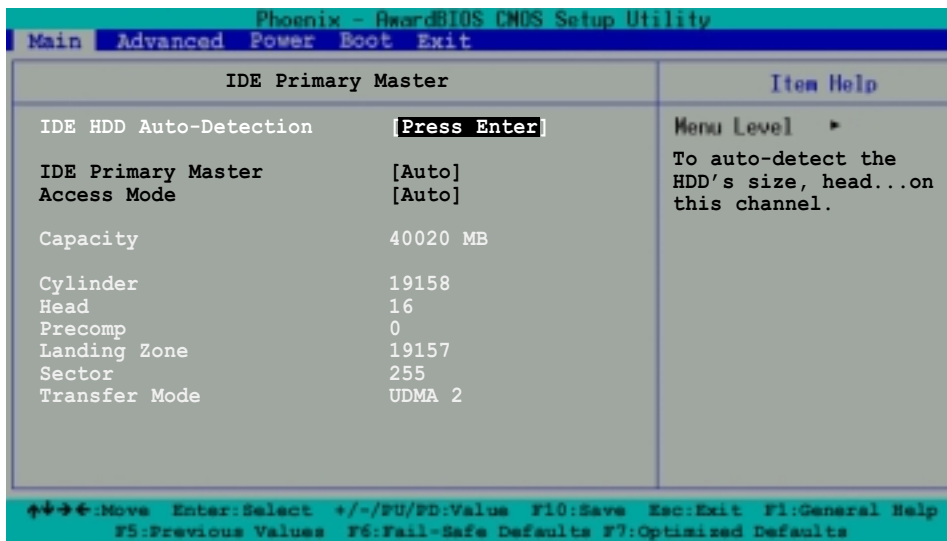

### IDE HDD Auto-Detection [Press Enter]

Press enter to automatically detect an IDE hard disk drive, if the hard drive is not already detected. In cases of undetected HDDs, pressing enter will detect the HDD and then open access to both the IDE Primary Master and Access Mode fields.

### IDE Primary Master/Slave [Auto] IDE Secondary Master/Slave [Auto]

Select [Auto] to automatically detect an IDE hard disk drive. If automatic detection is successful, the setup BIOS automatically fills in the correct values for the remaining fields on this sub-menu. If automatic detection fails, this may be because the hard disk drive is too old or too new. If the hard disk was already formatted on a previous system, the setup BIOS may detect incorrect parameters. In these cases, select [Manual] to manually enter the IDE hard disk drive parameters. If no drive is installed or if you are removing a drive and not replacing it, select [None]. Configuration options: [None] [Auto] [Manual]

### Access Mode [Auto]

The default [Auto] automatically detects an IDE hard disk drive. Select [CHS] in coordination with the [Manual] setting of the IDE Primary Master in order to enter the Hard Disk Drive values manually.



Before attempting to configure a hard disk drive, make sure you have the correct configuration information supplied by the drive manufacturer. Incorrect settings may cause the system to fail to recognize the installed hard disk.



## [Manual] & [CHS] Settings

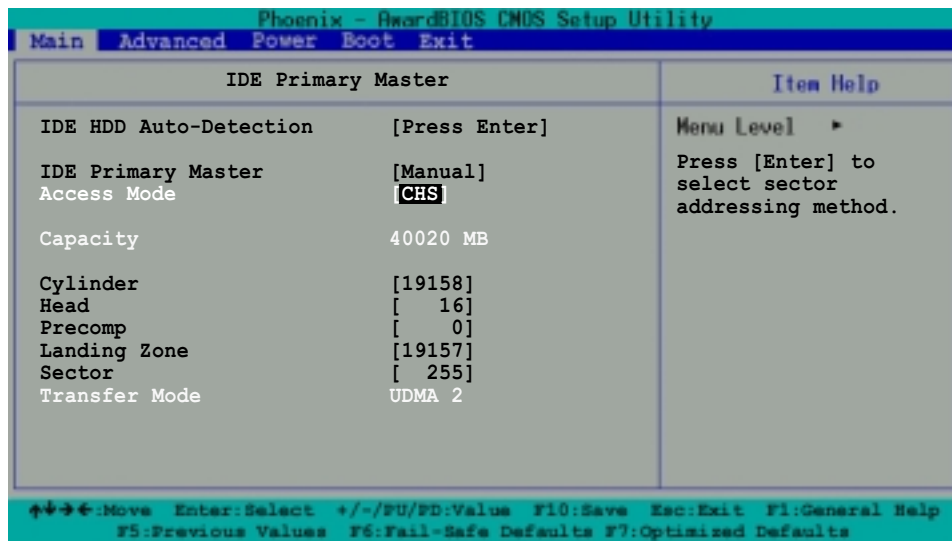

Manually enter the number of cylinders, heads and sectors per track for the drive. Refer to the drive documentation or the drive label for this information.



After entering the IDE hard disk drive information into BIOS, use a disk utility, such as FDISK, to partition and format new IDE hard disk drives. This is necessary so that you can write or read data from the hard disk. Make sure to set the partition of the Primary IDE hard disk drives to active.

After making your selections on this sub-menu, press the <Esc> key to return to the Main menu. The Main menu displays the hard disk drive field with your configuration.

### Access Mode [Auto]

Select the hard disk drive type in this field. When Logical Block Addressing (LBA) is enabled, the 28-bit addressing of the hard drive is used without regard for cylinders, heads, or sectors. Note that LBA Mode is necessary for drives with more than 504MB storage capacity. Select [CHS] to make manual entries for configuring the fields below. Configuration options: [CHS] [LBA] [Large] [Auto]

### Cylinders

This field configures the number of cylinders. Refer to the drive documentation to determine the correct value. To make changes to this field, set the IDE Primary Master field to [Manual] and the Access Mode to [CHS].

### Head

This field configures the number of read/write heads. Refer to the drive documentation to determine the correct value. To make changes to this field, set the IDE Primary Master field to [Manual] and the Access Mode to [CHS].

### Precomp

This field displays the precompressed volumes on the hard disk, if any, in MB.

## Landing Zone

This field displays the drive's maximum useable capacity as calculated by the BIOS based on the drive information you entered.

## Sector

This field configures the number of sectors per track. Refer to the drive documentation to determine the correct value. To make changes to this field, set the Type field to [User Type HDD] and the Translation Method field to [Manual].

## Transfer Mode

This field selects the UDMA transfer mode. Configuration options: [Auto] [UDMA0] [UDMA1] [UDMA2] [UDMA3] [UDMA4] [UDMA5]

## 2.5 Advanced Menu

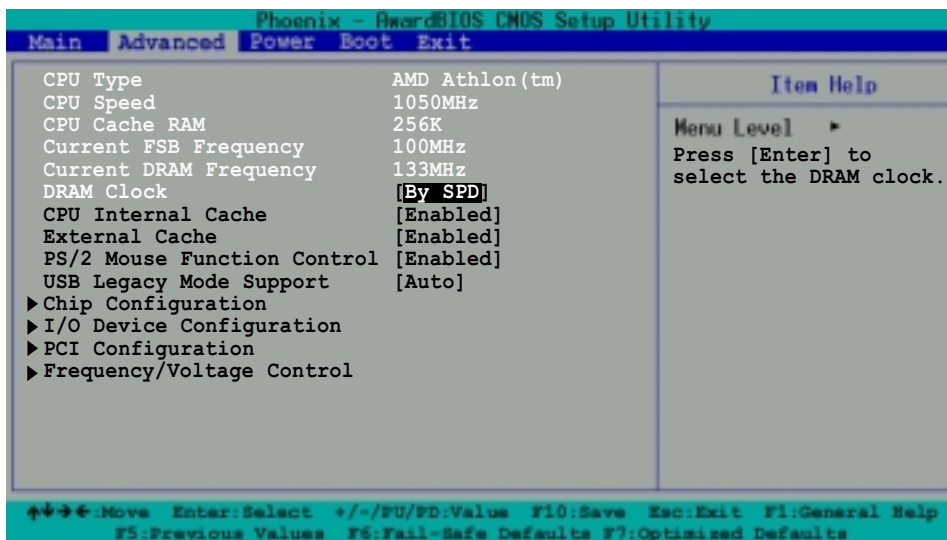

The Advanced menu displays the CPU type, speed, cache RAM, front side bus frequency and DRAM frequency information. It also contains the following BIOS parameters.

### DRAM Clock [By SPD]

The DRAM clock are set according to the DRAM SPD (Serial Presence Detect). You can manually set the DRAM clock parameters.

Configuration options: [By SPD] [133] [166]

### CPU Internal/External Cache [Enabled]/[Enabled]

These fields allow you to choose from the default of [Enabled] or choose [Disabled] to turn on or off the CPU internal and external built-in cache.

Configuration options: [Disabled] [Enabled]

## PS/2 Mouse Function Control [Enabled]

Setting this option to Enabled allows the operating system to determine whether to enable or disable the mouse. Set to Disabled prevents any installed PS/2 mouse from functioning and frees up IRQ 12. Configuration options: [Enabled] [Disabled]

## USB Legacy Support [Auto]

This motherboard supports Universal Serial Bus (USB) devices. The default of [Auto] allows the system to detect a USB device at startup. If detected, the USB controller legacy mode is enabled. If not detected, the USB controller legacy mode is disabled.

When you set this field to [Disabled], the USB controller legacy mode is disabled whether or not you are using a USB device. Configuration options: [Disabled] [Enabled] [Auto]

## 2.5.1 Chip Configuration

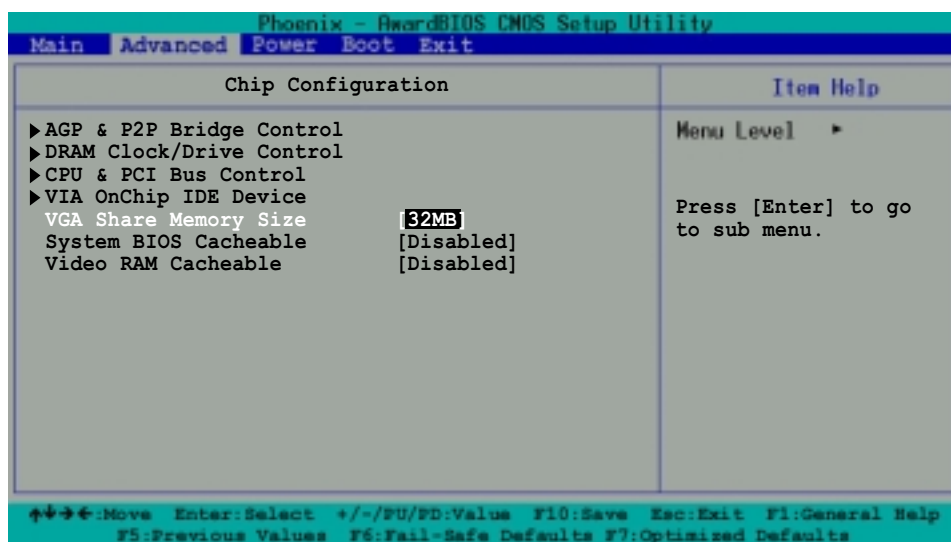

### VGA Share Memory Size [32M]

This field displays the share memory size for the onboard VGA. Configuration options: [16] [32] [64] [Disabled]

### System BIOS Cacheable [Disabled]

This field establishes whether or not the BIOS is cacheable. Disabled by default. Configuration options: [Enabled] [Disabled]

### Video RAM Cacheable [Disabled]

This field establishes whether or not the video RAM is cacheable. Disabled by default. Configuration options: [Enabled] [Disabled]

## AGP & P2P Bridge Control

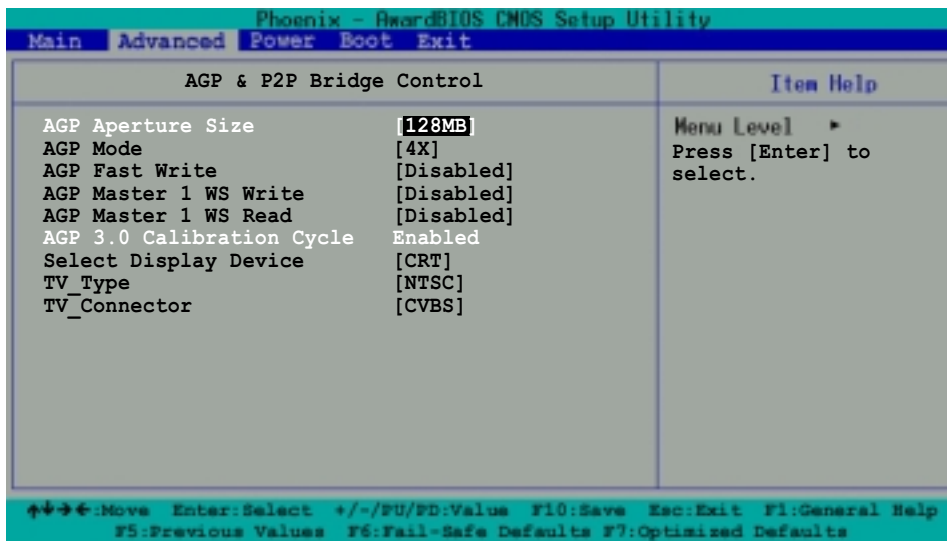

### AGP Aperture Size [XXXMB]

This field sets the size of mapped memory for AGP graphic data.

Configuration options: [4M] [8M] [16M] [32M] [64M] [128M] [256M] [512M] [1G]

### AGP Mode [4X]

AGP 4X transfers video data at 1066MB/s and is backward-compatible to AGP 1X video card. When set to [1X], the AGP interface only provides a peak data throughput of 266MB/s even if you are using an AGP 4x card.

Configuration options: [1X] [2X] [4X]

### AGP Fast Write [Disabled]

This field enables or disables the AGP Fastwrite function.

Configuration options: [Disabled] [Enabled]

### AGP Master 1 WS Write [Disabled]

Configuration options: [Disabled] [Enabled]

### AGP Master 1 WS Read [Disabled]

Configuration options: [Disabled] [Enabled]

### AGP 3.0 Calibration Cycle [Enabled]

This item is enabled by default.

### Select Display Device [CRT]

This item allows you to select the type of display device.

Configuration options: [CRT] [TV] [CRT+TV] [DVI] [CRT+DVI] [TV+DVI]

## TV\_Type [NTSC]

This option allows you to select the TV standard for TV display output.  
Configuration options: [NTSC] [PAL] [PALM] [PALN] [PALNc]

## TV\_Connector [CVBS]

This item allows you to select the TV connector.  
Configuration options: [CVBS] [S-Video 0]

## DRAM Clock/Drive Control

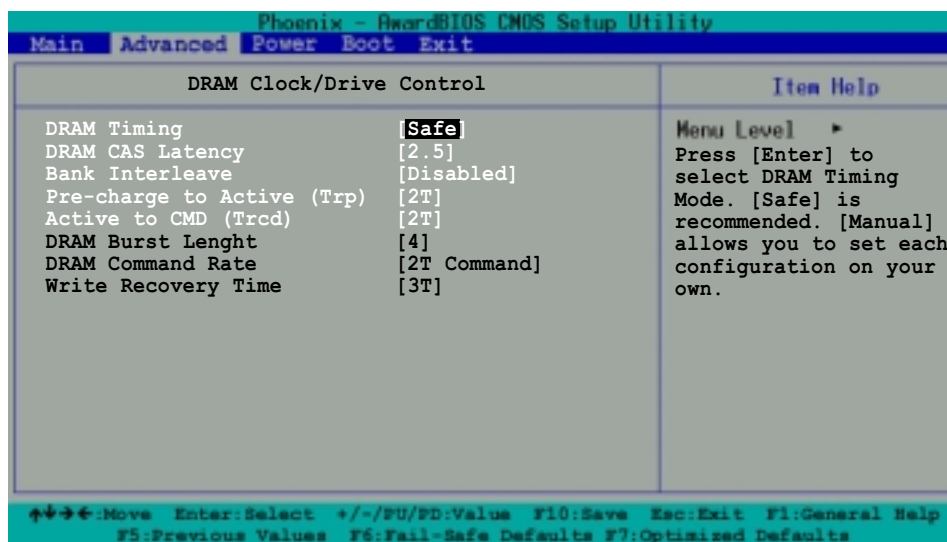

## DRAM Timing [Safe]

It is recommended that you set this parameter to [Safe]. Setting to [Auto by SPD] synchronizes the DRAM timing with the DRAM Clock. Setting to [Manual] allows you to set the values for DRAM CAS Latency, Bank Interleave, Pre-charge to Active (TRP) and Active to CMD (Trcd) parameters.  
Configuration options: [Safe] [Auto By SPD] [Manual]

## DRAM CAS Latency [2.5]

This field sets the override clock cycle for the latency time between the DRAM read command and the moment that the data actually becomes available. Normally, the system determines the rate automatically by default. Configuration options: [1.5] [2] [2.5] [3]

## Bank Interleave [Disabled]

Configuration options: [Disabled] [2 Bank] [4 Bank]

## Precharge to Active (Trp) [2T]

Configuration options: [2T] [3T]

## Active to CMD (Trcd) [2T]

Configuration options: [2T] [3T]

## DRAM Burst Length [4]

Configuration options: [4] [8]

## DRAM Command Rate [2T Command]

Configuration options: [2T Command] [1T Command]

## Write Recovery Time [3T]

Configuration options: [3T] [2T]

## CPU & PCI Bus Control

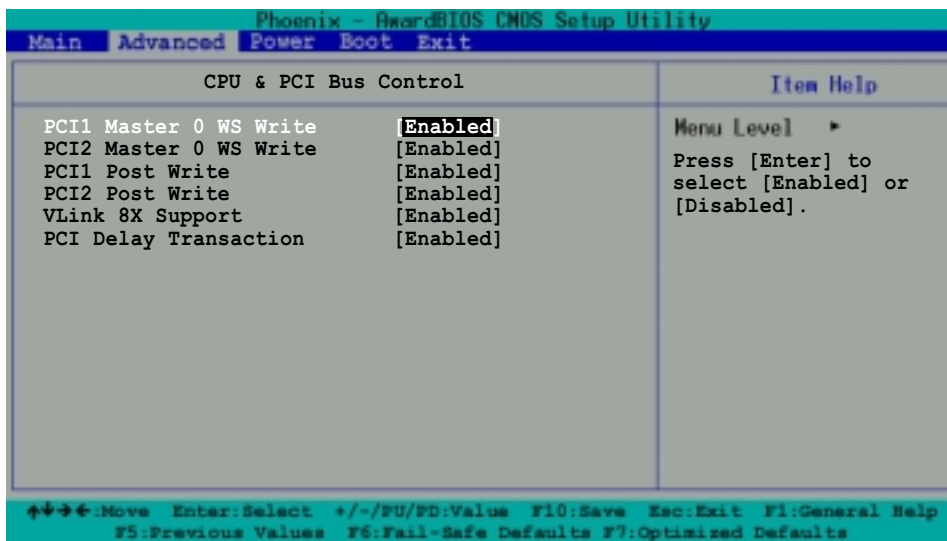

### PCI1 Master 0 WS Write [Enabled]

### PCI2 Master 0 WS Write [Enabled]

Configuration options: [Enabled] [Disabled]

### PCI1 Post Write [Enabled]

### PCI2 Post Write [Enabled]

Configuration options: [Enabled] [Disabled]

### VLink 8X Support [Enabled]

This option enables or disables the VLink 8X feature of the motherboard. The VLink 8X technology allows high bandwidth connection between the North bridge and South bridge chipsets. Configuration options: [Enabled] [Disabled]

### PCI Delay Transaction [Enabled]

When set to [Enabled], this feature frees the PCI bus when the CPU is accessing 8-bit ISA cards. This process consumes 50-60 PCI clocks without PCI delayed transaction. Set this field to [Disabled] when using ISA cards that are not PCI 2.2 compliant. Configuration options: [Enabled] [Disabled]

## VIA OnChip IDE Device

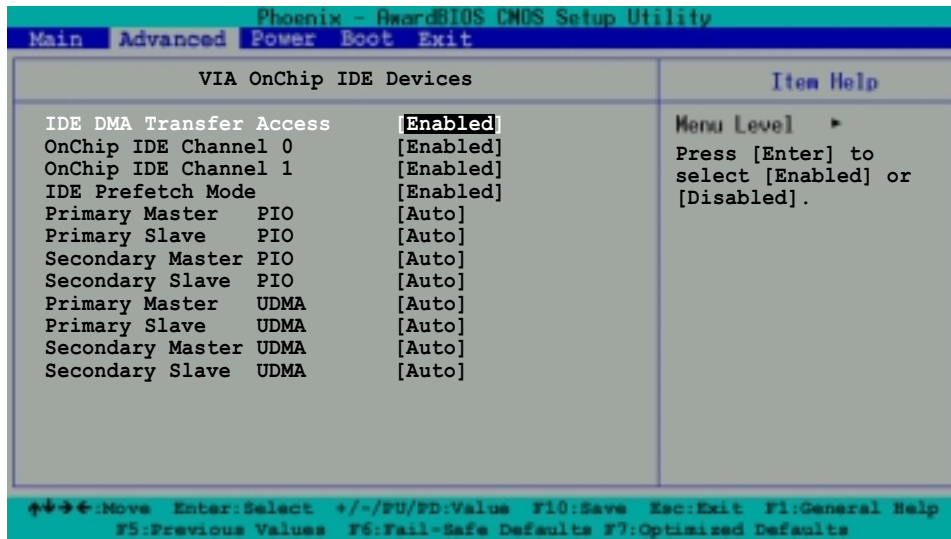

### IDE DMA Transfer Access [Enabled]

Configuration options: [Enabled] [Disabled]

### OnChip IDE Channel 0 [Enabled]

### OnChip IDE Channel 1 [Enabled]

Configuration options: [Enabled] [Disabled]

### IDE Prefetch Mode [Enabled]

Configuration options: [Enabled] [Disabled]

### Primary Master PIO [Auto]

### Primary Slave PIO [Auto]

This option lets you set a PIO (Programmable Input/Output) mode for Primary IDE devices. Configuration options: [Auto] [Mode 0] [Mode 1] [Mode 2] [Mode 3] [Mode 4]

### Secondary Master PIO [Auto]

### Secondary Slave PIO [Auto]

This option lets you set a PIO (Programmable Input/Output) mode for Secondary IDE devices. Configuration options: [Auto] [Mode 0] [Mode 1] [Mode 2] [Mode 3] [Mode 4]

### Primary Master/Slave UDMA [Auto]

### Secondary Master/Slave UDMA [Auto]

UltraDMA capability allows improved transfer speeds and data integrity for compatible IDE devices. Set to Auto to for automatic configuration. Configuration options: [Auto] [Disabled]



## 2.5.2 I/O Device Configuration

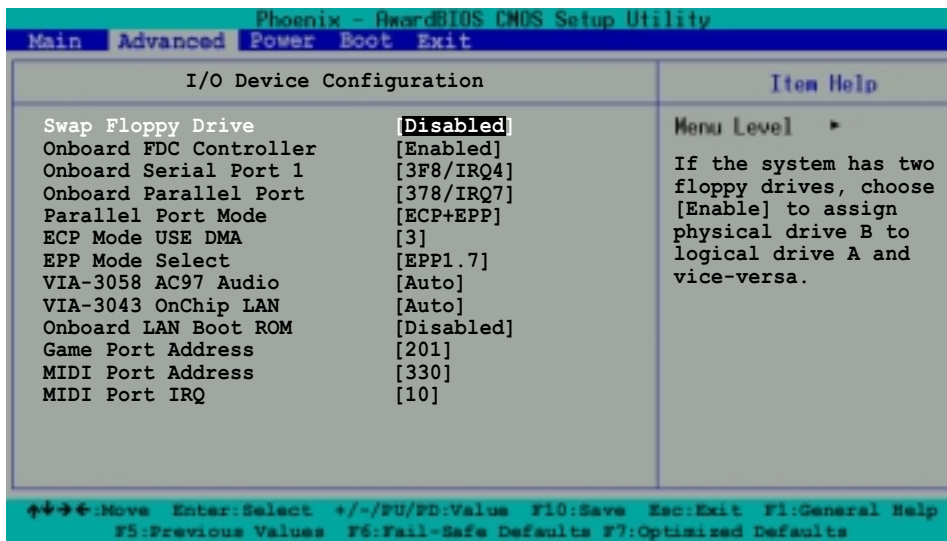

### Swap Floppy Drive [Disabled]

Enable this option to assign physical drive B to logical drive A, and vice-versa.  
Configuration options: [Disabled] [Enabled]

### Onboard FDC Controller [Enabled]

This field allow you to enable the onboard FDC controller.  
Configuration options: [Enabled] [Disabled]

### Onboard Serial Port 1 [3F8/IRQ4]

These fields allow you to set the address for the onboard serial connector.  
Configuration options: [3F8/IRQ4] [2F8/1RQ3] [3E8/IRQ4] [2E8/IRQ3] [Auto] [Disabled]

### Onboard Parallel Port [378/IRQ7]

This field allows you to set the address of the onboard parallel port connector.  
Configuration options: [378/IRQ7] [278/IRQ5] [3BC/1RQ7]

### Parallel Port Mode [ECP+EPP]

This field allows you to set the operation mode of the parallel port. [SPP] allows normal-speed operation but in one direction only; [EPP] allows bidirectional parallel port operation; [ECP] allows the parallel port to operate in bidirectional DMA mode; [ECP+EPP] allows normal speed operation in a two-way mode.  
Configuration options: [ECP+EPP] [EPP] [ECP] [SPP]

### ECP Mode USE DMA [3]

This field sets the parallel port DMA channel for the selected ECP mode. The default setting is 3. This selection is available only if you select [ECP] or [ECP+EPP] in the Parallel Port Mode item. Configuration options: [3] [1]



### **EPP Mode Select [EPP1.7]**

This item allows you to set the EPP mode. The default setting is EPP1.7. This selection is available only if you select [EPP] or [ECP+EPP] in the Parallel Port Mode item. Configuration options: [EPP1.7] [EPP1.9]

### **VIA-3058 AC97 Audio [Auto]**

This field allows you to enable or disable the onboard AC97 audio controller. Configuration options: [Auto] [Disabled]

### **VIA-3043 OnChip LAN [Auto]**

This field allows you to enable or disable the onboard LAN controller. Configuration options: [Auto] [Disabled]

### **Onboard LAN Boot ROM [Disabled]**

This field allows you to turn on or off the onboard LAN boot ROM. This item appears only when onboard LAN is enabled. Configuration options: [Disabled] [Enabled]

### **Game Port Address [201]**

This field allows you to select the onboard Game port address. Configuration options: [201] [209] [Disabled]

### **MIDI Port Address [330]**

This field allows you to select the onboard MIDI port address. Configuration options: [330] [300] [290] [Disabled]

### **MIDI Port IRQ [10]**

This field allows you to set the IRQ assignment of the onboard MIDI port. Configuration options: [330] [300] [290] [Disabled]

## 2.5.3 PCI Configuration

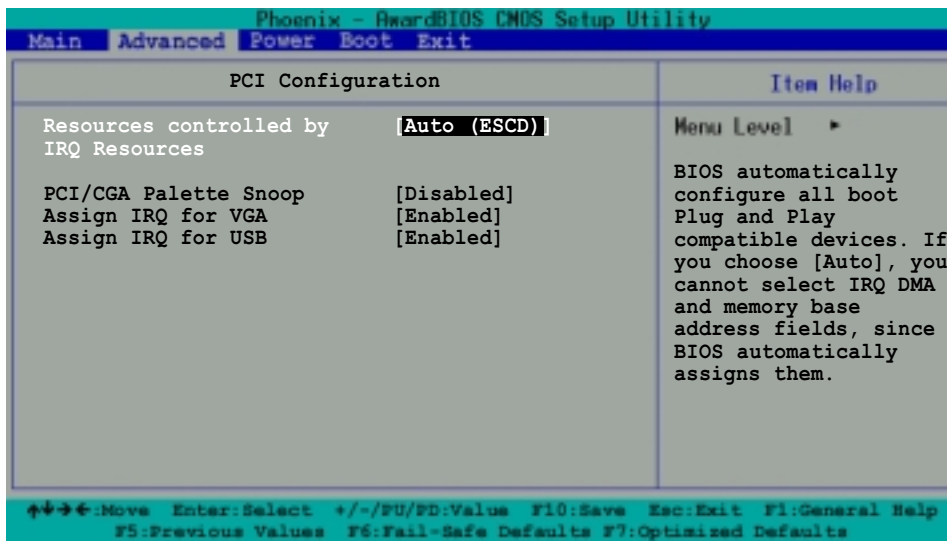

### Resources Controlled by [Auto (ESCD)]

When set to [Auto (ESCD)], BIOS automatically configures all boot Plug and Play devices. Setting to [Manual] enables the IRQ Resources sub-menu for manual assignment of IRQ addresses. Configuration options: [Auto (ESCD)] [Manual]

### PCI/VGA Snoop Palette [Disabled]

Some non-standard VGA cards, like graphics accelerators or MPEG video cards, may not show colors properly. Setting this field to [Enabled] corrects this problem. If you are using a standard VGA card, leave this field to the default setting [Disabled]. Configuration options: [Disabled] [Enabled]

### Assign IRQ for VGA [Enabled]

Setting this option to [Enabled] allows the BIOS to automatically assign an IRQ address for the VGA controller. Configuration options: [Enabled] [Disabled]

### Assign IRQ for USB [Enabled]

Setting this option to [Enabled] allows the BIOS to automatically assign an IRQ address for the USB controller. Configuration options: [Enabled] [Disabled]

## IRQ Resources

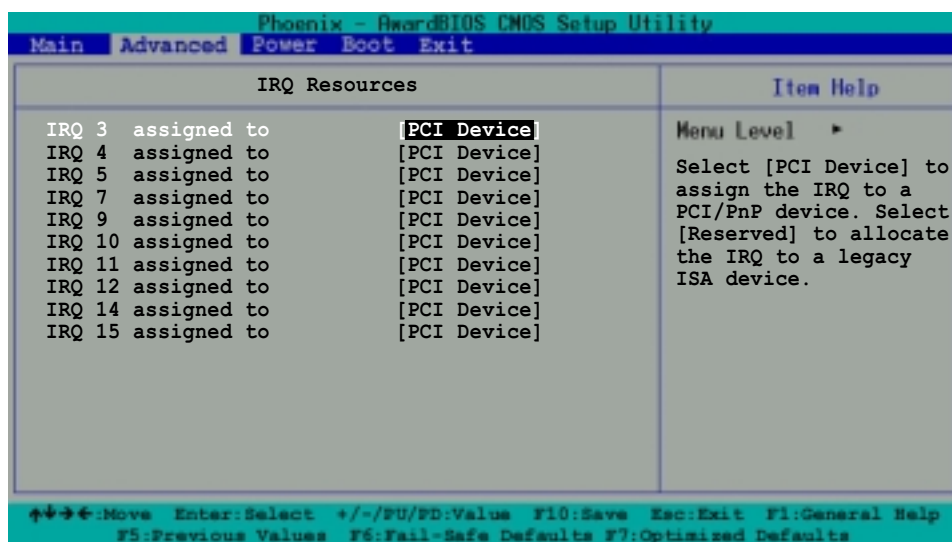

### IRQ 3, 4, 5, 7, 9, 10, 11, 12, 14, 15 assigned to [PCI Device]

The IRQ Resources sub-menu is activated when the **Resources Controlled by** parameter is set to [Manual]. Select [PCI Device] to assign an IRQ address to a Plug and Play device. Setting to [Reserved] reserves the IRQ address.

Configuration options: [PCI Devices] [Reserved]

## 2.5.4 Frequency/Voltage Control

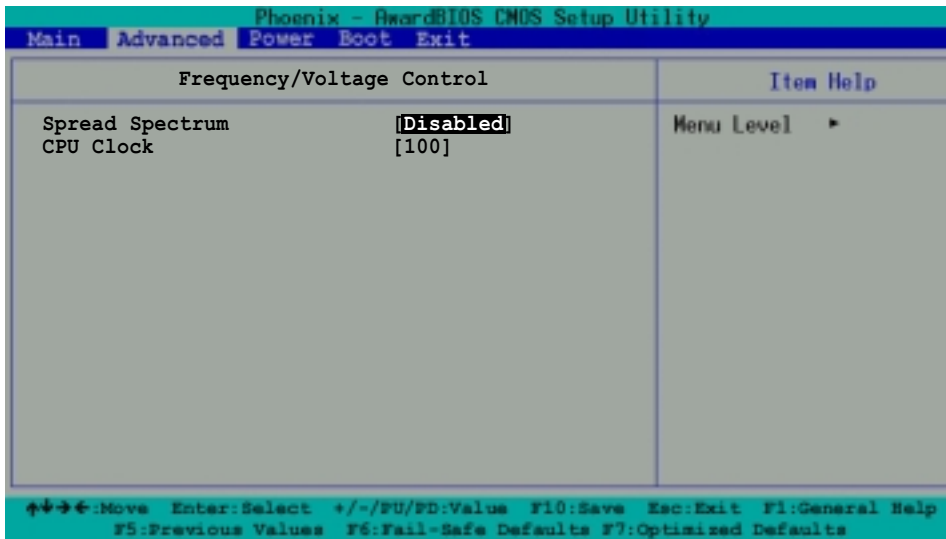

### Spread Spectrum [Disabled]

This field enables or disables the clock generator spread spectrum.

Configuration options: [Disabled] [-1.50%] [-1.00%] [-0.70%] [-0.50%] [ +/-0.75%] [ +/-0.50%] [ +/-0.35%] [ +/-0.25%]

### CPU Clock [100]

This item allows you to set the CPU frequency. To do so, highlight the item, then press <Enter> to display a pop-up menu. Key-in a value from the specified range, then press <Enter>. Configuration options: [Min=100] [Max=165]

## 2.6 Power Menu

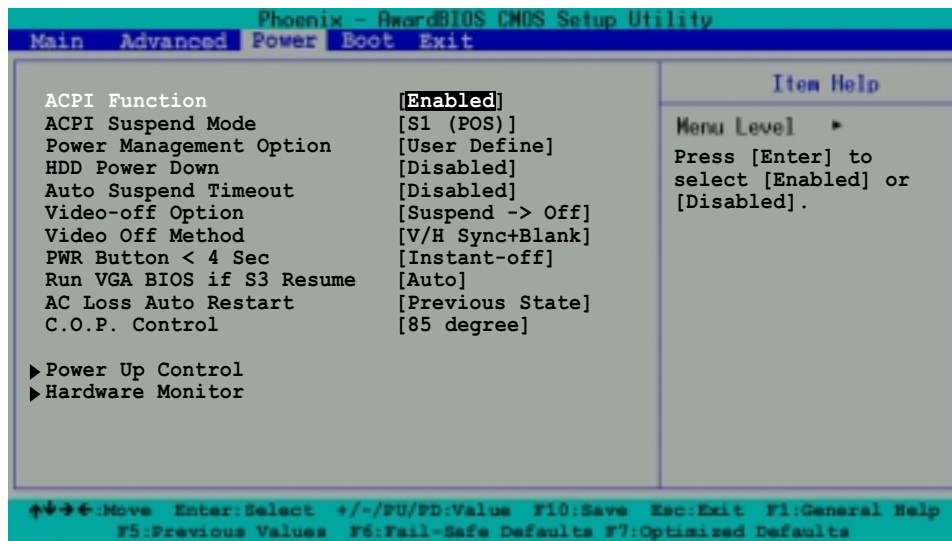

### ACPI Function [Enabled]

Allows you to enable or disable the ACPI 2.0 support.  
Configuration options: [Enabled] [Disabled]

### ACPI Suspend Mode [S1 (POS)]

Allows you to select the ACPI state to used for system suspend.  
Configuration options: [S1 (POS)] [S3 (STR)] [S1 & S3]

### Power Management Option [User Define]

Configuration options: [User Define] [Min Saving] [Max Saving]

### HDD Power Down [Disabled]

Shuts down any IDE hard disk drives in the system after a period of inactivity as set in this user-configurable field. This feature does not affect SCSI hard drives.  
Configuration options: [Disabled] [1Min]...[15Min]

### Auto Suspend Timeout [Disabled]

Sets the time period before the system goes into suspend mode.  
Configuration options: [Disabled] [1Min] [2Min] [4Min] [6Min] [8Min] [10Min] [20Min] [30Min] [40Min] [1Hour]

### Video Off Option [Suspend -> Off ]

This field determines when to activate the video off feature for monitor power management. Configuration options: [Suspend -> Off] [Always On]

### **Video Off Method [V/H Sync+Blank]**

This field defines the video off features. The Display Power Management System (DPMS) feature allows the BIOS to control the video display card if it supports the DPMS feature. [Blank Screen] only blanks the screen. Use this for monitors without power management or “green” features. Configuration options: [V/H Sync+Blank] [Blank Screen] [DPMS support]

### **PWR Button < 4 Sec [Instant-off]**

When set to [Instant-off], the ATX switch can be used as a normal system power-off button when pressed for less than 4 seconds. [Suspend] allows the button to have a dual function where pressing less than 4 seconds puts the system in sleep mode. Regardless of the setting, holding the ATX switch for more than 4 seconds powers off the system. Configuration options: [Instant-off] [Suspend]

### **Run VGA BIOS if S3 Resume [Auto]**

Configuration options: [Auto] [Yes] [No]

### **AC Loss Auto Restart [Previous State]**

This allows you to set whether or not to reboot the system after AC power loss. [Off] leaves your system off while [On] reboots the system. [Previous State] sets the system back to the state it was before the power interruption. Configuration options: [Previous State] [On] [Off]

### **C.O.P. Control [85 degree]**

Sets the threshold value for the CPU temperature. The ASUS CPU Overheating Protection (C.O.P.) feature of this motherboard automatically shuts down the system when the CPU temperature reaches or exceeds the threshold value. Configuration options: [85 degree] [95 degree]

## 2.6.1 Power Up Control

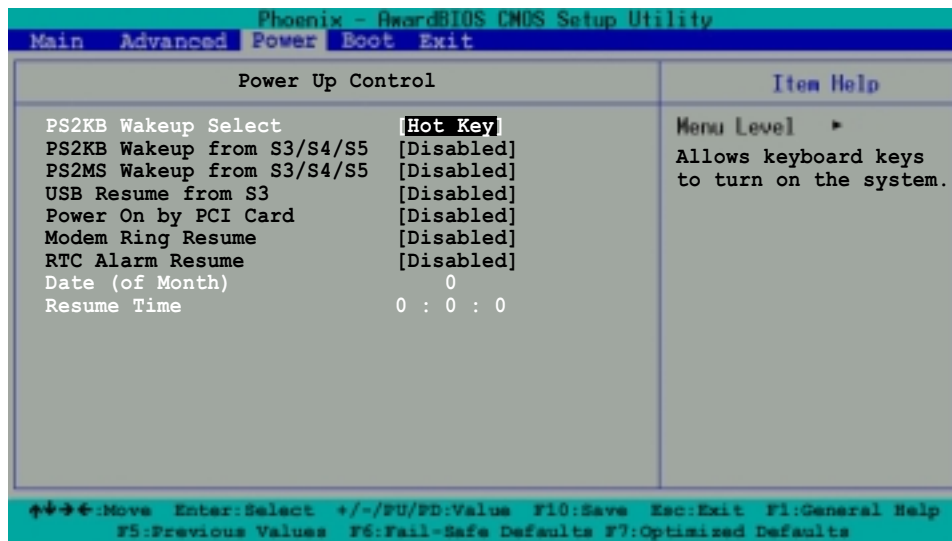

### PS2KB Wakeup Select [Hot Key]

This parameter allows you to use specific keys on the keyboard to turn on the system. This feature requires an ATX power supply that provides at least 1A on the +5VSB lead. Configuration options: [Disabled] [Ctrl+F1]...[Ctrl+F12] [Power] [Wake] [Any Key]

### PS2KB Wakeup from S3/S4/S5 [Disabled]

When set to [Enabled], this parameter allows you to use the PS/2 keyboard to turn on the system. Configuration options: [Disabled] [Enabled]

### PS2MS Wakeup from S3/S4/S5 [Disabled]

When set to [Enabled], this parameter allows you to use the PS/2 mouse to turn on the system. This requires an ATX power supply that provides at least 1A on the +5VSB lead. Configuration options: [Disabled] [Enabled]

### USB Resume from S3 [Disabled]

Configuration options: [Disabled] [Enabled]

### Power On by PCI Card [Disabled]

When set to [Enabled], this parameter allows you to turn on the system through the PCI LAN or modem card. This feature requires an ATX power supply that provides at least 1A on the +5VSB lead. Configuration options: [Disabled] [Enabled]

### Modem Ring Resume [Disabled]

This allows either settings of [Enabled] or [Disabled] for powering up the computer when the external modem receives a call while the computer is in Soft-off mode. Configuration options: [Disabled] [Enabled]

### RTC Alarm Resume [Disabled]

Allows you to enable or disable RTC to generate a wake event. When this item is enabled, the Date and Resume Time fields are activated for manual setup. Configuration options: [Disabled] [Enabled]

## 2.6.2 Hardware Monitor

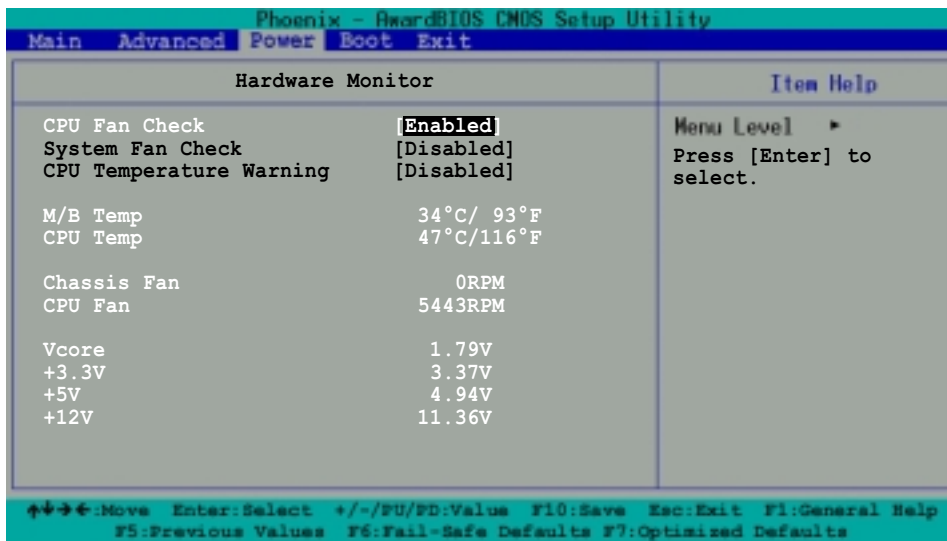

### CPU Fan Check [Enabled]

Setting this option to Enabled allows the onboard hardware monitor to check the CPU fan speed. Configuration options: [Enabled] [Disabled]

### System Fan Check [Enabled]

This option allows the onboard hardware monitor to check the system fan rotation. Configuration options: [Enabled] [Disabled]

### CPU Warning Temp [Disabled]

This option allows BIOS to set a threshold value for the CPU temperature. The system shuts down when the CPU temperature reaches the threshold value. Configuration options: [Disabled] [50°C/122°F] [53°C/127°F] [56°C/133°F] [60°C/140°F] [63°C/145°F] [66°C/151°F] [70°C/158°F]

### M/B Temp [xxx°C/xxx°F]

### CPU Temp [xxx°C/xxx°F]

The onboard hardware monitor automatically detects and displays the motherboard and CPU temperatures.

### Chassis Fan [xxxxRPM] or [0RPM]

### CPU Fan [xxxxRPM] or [0RPM]

The onboard hardware monitor automatically detects and displays the CPU and chassis fan speeds in rotations per minute (RPM). If any of the fans is not connected to the motherboard, that field shows 0RPM.

### Vcore, +3.3V, +5V, +12V

The onboard hardware monitor automatically detects the voltage output through the onboard voltage regulators.



## 2.7 Boot Menu

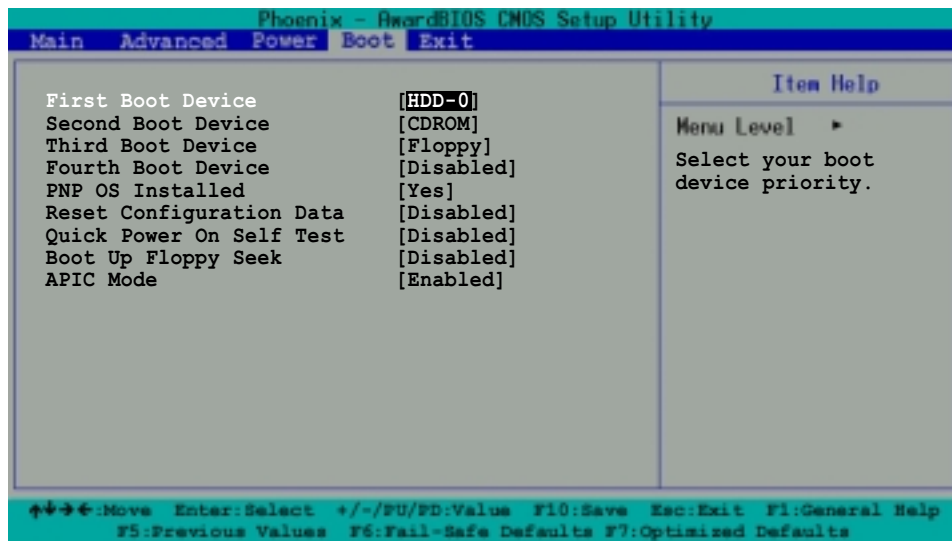

### First, Second, Third, Fourth Boot Device

The Boot Menu allows you to select 13 types of boot devices. Promotion or demotion of devices alters the priority which the system uses to boot device on system power up. Configuration options include [Floppy] [LS120] [HDD-0] [SCSI] [CDROM] [HDD-1] [HDD-2] [HDD-3] [ZIP100] [USB-FDD] [USB-ZIP] [USB-CDROM] [USB-HDD] [LAN] [Disabled]

### PNP OS Installed [Yes]

This field allows you to use a Plug and Play (PnP) operating system to configure the PCI bus slots instead of using the BIOS. When [Yes] is selected, interrupts may be reassigned by the OS. If you installed a non-PnP OS or if you want to prevent reassigning of interrupt settings, keep the default setting [No].

Configuration options: [Yes] [No]

### Reset Configuration Data [Disabled]

Select [Enabled], if you want to clear the Extended System Configuration Data (ESCD). Configuration options: [Disabled] [Enabled]

### Quick Power-On-Self-Test [Disabled]

This field speeds up the Power-On-Self Test (POST) routine by skipping retesting several times. Configuration options: [Disabled] [Enabled]

### Boot up Floppy Seek [Disabled]

When enabled, the BIOS will seek the floppy disk drive to determine whether the drive has 40 or 80 tracks. Configuration options: [Disabled] [Enabled]

### APIC Mode [Enabled]

When enabled, this option allows you to distribute interrupt routings other than the 16 IRQs. The Programmable Interrupt Controller (PIC) setting allows you to use the 16 IRQs only. Configuration options: [Enabled] [Disabled]

## 2.8 Exit Menu

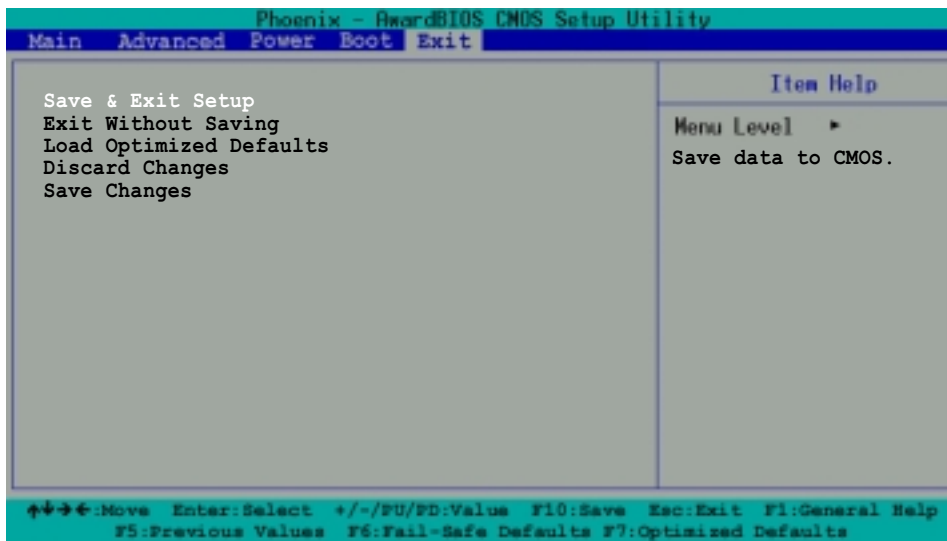

### Save & Exit Setup

Once you are finished making your selections, choose this option from the Exit menu to ensure the values you selected are saved to the CMOS RAM. The CMOS RAM is sustained by an onboard backup battery and stays on even when the PC is turned off. When you select this option, a confirmation window appears. Select [Yes] to save changes and exit.

### Exit Without Saving

Select this option only if you do not want to save the changes that you made to the Setup program. If you made changes to fields other than system date, system time, and password, the BIOS asks for a confirmation before exiting.

### Load Optimized Defaults

This option allows you to load the optimized values for each of the parameters on the Setup menus. When you select this option or if you press <F7>, a confirmation window appears. Select [Yes] to load optimized values. Select Save & Exit or make other changes before saving the values to the non-volatile RAM.

### Discard Changes

This option allows you to discard the selections you made and restore the previously saved values. After selecting this option, a confirmation appears. Select [Yes] to discard any changes and load the previously saved values.

### Save Changes

This option saves your selections without exiting the Setup program. You can then return to other menus and make further changes. After you select this option, a confirmation window appears. Select [Yes] to save changes to the non-volatile RAM.

# ***Chapter 3***

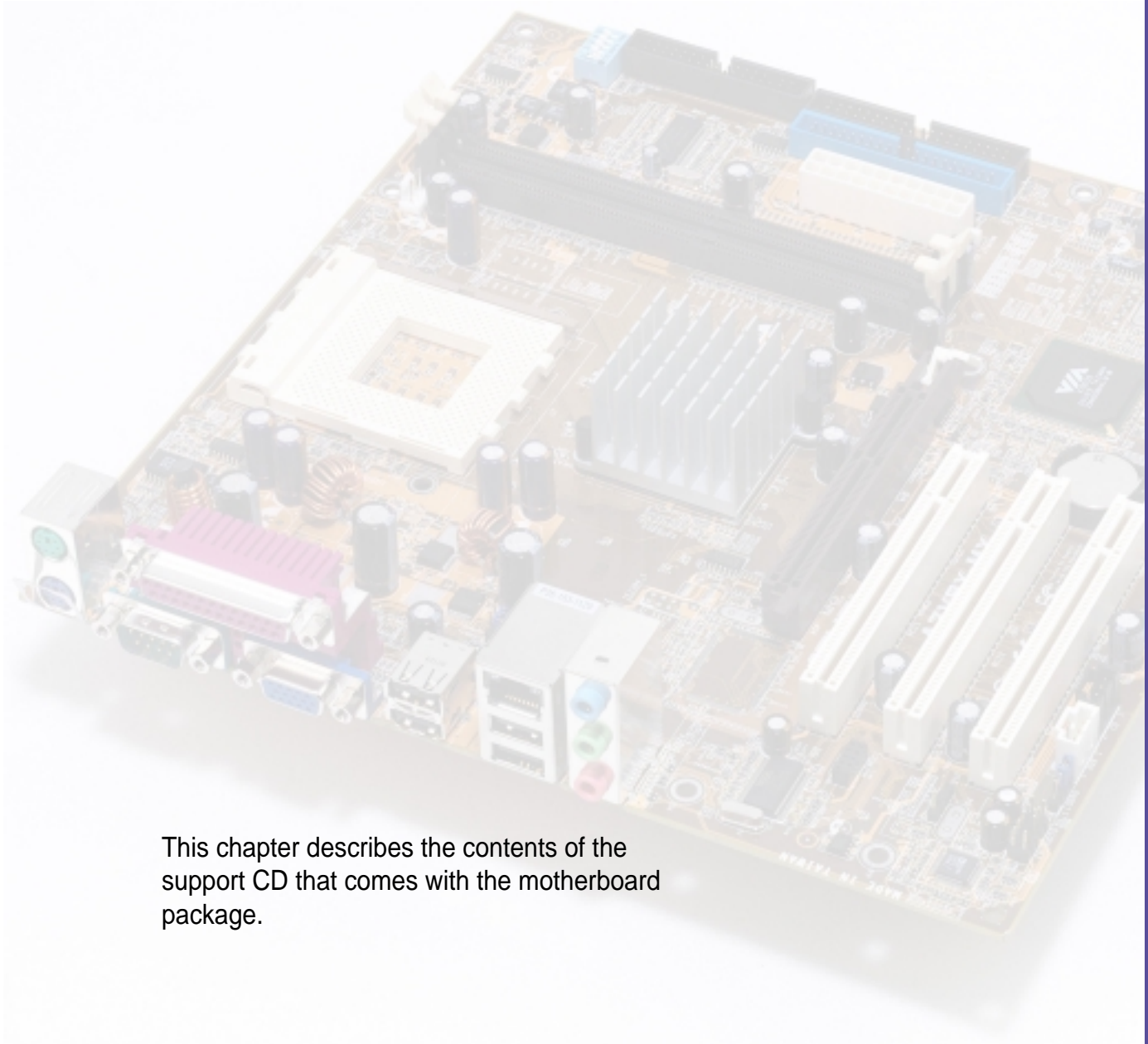

This chapter describes the contents of the support CD that comes with the motherboard package.

## **Software support**

## 3.1 Installing an operating system

This motherboard supports Windows® 98SE/ME/2000/XP as well as Linux Red Hat, SuSE, TurboLinux and Caldera operating systems (OS). Always install the latest OS version and corresponding updates so you can maximize the features of your hardware.



Because motherboard settings and hardware options vary, use the setup procedures presented in this chapter for general reference only. Refer to your OS documentation for more information.

## 3.2 Support CD information

The support CD that came with the motherboard contains useful software and several utility drivers that enhance the motherboard features.



The contents of the support CD are subject to change at any time without notice. Visit the ASUS website for updates.

### 3.2.1 Running the support CD

To begin using the support CD, insert the CD to your CD-ROM drive. The CD automatically displays the **Drivers** menu if Autorun is enabled in your computer.

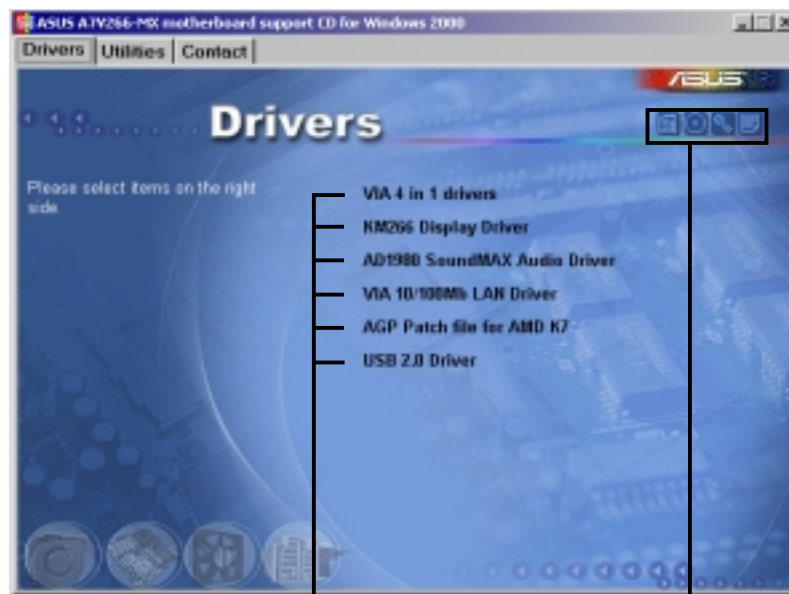

Click an item to install

Click an icon to display more information



- If **Autorun** is NOT enabled in your computer, browse the contents of the support CD to locate the file ASSETUP.EXE from the BIN folder. Double-click the **ASSETUP.EXE** to run the CD.
- Some menu items appear only to specific operating system versions.

## 3.2.2 Drivers menu

The drivers menu shows the available device drivers if the system detects installed devices. Install the necessary drivers to activate the devices.



---

Screen display and driver options may not be the same for other operating system versions.

---

### **VIA 4 in 1 Driver**

The item installs the following drivers:

- VIA Registry (INF) driver
- VIA AGP VxD driver
- VIA ATAPI vendor support driver
- VIA PCI IRQ Miniport driver

### **KM266 Display Driver**

Click this item to install the KM266 display driver for the onboard VGA.

### **AD1980 SoundMAX Audio Driver**

This item installs the AD1980 SoundMAX audio driver and applications.

### **VIA 10/100Mb LAN Driver**

Click this item to install the VIA 10/100Mb Fast Ethernet Adapter driver for your local area network (LAN).

### **AGP Patch file for AMD K7**

Click this item to install the AGP patch file for AMD K7 systems.

### **USB 2.0 Driver**

This item installs the USB 2.0 driver.

### 3.2.3 Utilities menu

The drivers menu shows the available device drivers if the system detects installed devices. Install the necessary drivers to activate the devices.

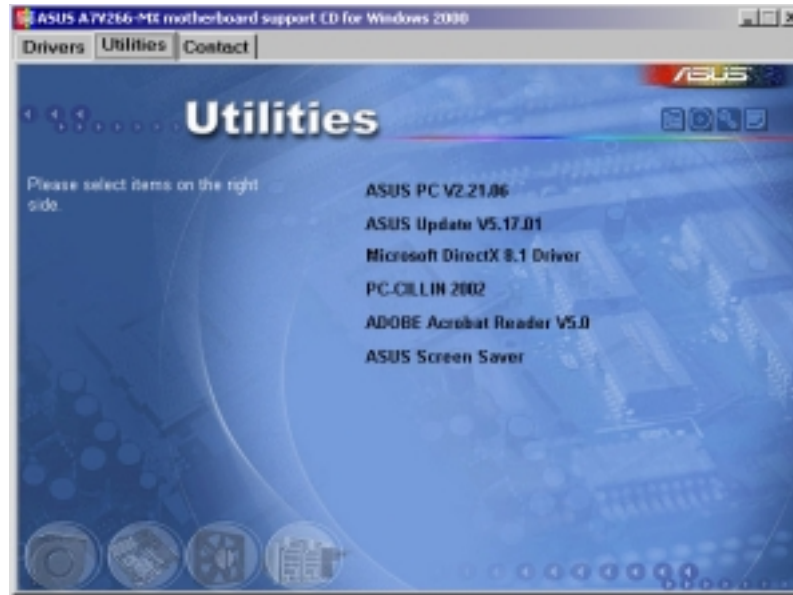

#### **ASUS PC Probe**

This utility continuously monitors vital system information such as fan rotations, CPU temperature, and system voltages, and alerts you on any detected problems. This utility helps you keep your computer in a healthy operating condition.

#### **ASUS Update**

The ASUS Update is a utility that allows you to update the motherboard BIOS and drivers. This utility requires an Internet connection either through a network or an Internet Service Provider (ISP).

#### **Microsoft DirectX 8.1**

This item installs the Microsoft DirectX 8.1 drivers.

#### **PC-CILLIN 2002**

This item installs the PC-cillin 2002 anti-virus program. View the PC-cillin online help for detailed information.

#### **Adobe Acrobat Reader**

This item installs the Adobe Acrobat Reader. The Acrobat Reader software is for viewing files saved in Portable Document Format (PDF).

#### **ASUS Screensaver**

This item installs the ASUS screensaver.

## 3.2.4 ASUS contact information

Click the Contact tab to display ASUS contact information.



