

ASUS[®] A7V266-EX

JumperFree™ DDR DRAM

266MHz FSB AGP Pro/4X

Socket A Motherboard

USER'S MANUAL

USER'S NOTICE

No part of this manual, including the products and software described in it, may be reproduced, transmitted, transcribed, stored in a retrieval system, or translated into any language in any form or by any means, except documentation kept by the purchaser for backup purposes, without the express written permission of ASUSTeK COMPUTER INC. ("ASUS").

ASUS PROVIDES THIS MANUAL "AS IS" WITHOUT WARRANTY OF ANY KIND, EITHER EXPRESS OR IMPLIED, INCLUDING BUT NOT LIMITED TO THE IMPLIED WARRANTIES OR CONDITIONS OF MERCHANTABILITY OR FITNESS FOR A PARTICULAR PURPOSE. IN NO EVENT SHALL ASUS, ITS DIRECTORS, OFFICERS, EMPLOYEES OR AGENTS BE LIABLE FOR ANY INDIRECT, SPECIAL, INCIDENTAL, OR CONSEQUENTIAL DAMAGES (INCLUDING DAMAGES FOR LOSS OF PROFITS, LOSS OF BUSINESS, LOSS OF USE OR DATA, INTERRUPTION OF BUSINESS AND THE LIKE), EVEN IF ASUS HAS BEEN ADVISED OF THE POSSIBILITY OF SUCH DAMAGES ARISING FROM ANY DEFECT OR ERROR IN THIS MANUAL OR PRODUCT.

Product warranty or service will not be extended if: (1) the product is repaired, modified or altered, unless such repair, modification or alteration is authorized in writing by ASUS; or (2) the serial number of the product is defaced or missing.

Products and corporate names appearing in this manual may or may not be registered trademarks or copyrights of their respective companies, and are used only for identification or explanation and to the owners' benefit, without intent to infringe.

- Intel and Pentium are registered trademarks of Intel Corporation.
- VIA is a registered trademark of VIA Technologies, Inc.
- 3Com is a registered trademark of 3Com Corporation.
- C-Media is a registered trademark of C-Media Electronics Inc.
- Windows and MS-DOS are registered trademarks of Microsoft Corporation.
- Adobe and Acrobat are registered trademarks of Adobe Systems Incorporated.
- Trend and ChipAwayVirus are trademarks of Trend Micro, Inc.
- Symbios is a registered trademark of Symbios Logic Corporation.

The product name and revision number are both printed on the product itself. Manual revisions are released for each product design represented by the digit before and after the period of the manual revision number. Manual updates are represented by the third digit in the manual revision number.

For previous or updated manuals, BIOS, drivers, or product release information, contact ASUS at <http://www.asus.com.tw> or through any of the means indicated on the following page.

SPECIFICATIONS AND INFORMATION CONTAINED IN THIS MANUAL ARE FURNISHED FOR INFORMATIONAL USE ONLY, AND ARE SUBJECT TO CHANGE AT ANY TIME WITHOUT NOTICE, AND SHOULD NOT BE CONSTRUED AS A COMMITMENT BY ASUS. ASUS ASSUMES NO RESPONSIBILITY OR LIABILITY FOR ANY ERRORS OR INACCURACIES THAT MAY APPEAR IN THIS MANUAL, INCLUDING THE PRODUCTS AND SOFTWARE DESCRIBED IN IT.

Copyright © 2002 ASUSTeK COMPUTER INC. All Rights Reserved.

Product Name: **ASUS A7V266-EX**
Manual Revision: **1.00 E935**
Release Date: **January 2002**

ASUS CONTACT INFORMATION

ASUSTeK COMPUTER INC. (Asia-Pacific)

Marketing

Address: 150 Li-Te Road, Peitou, Taipei, Taiwan 112
Telephone: +886-2-2894-3447
Fax: +886-2-2894-3449
Email: info@asus.com.tw

Technical Support

MB/Others (Tel): +886-2-2890-7121 (English)
Notebook (Tel): +886-2-2890-7122 (English)
Desktop/Server (Tel): +886-2-2890-7123 (English)
Fax: +886-2-2890-7698
Email: tsd@asus.com.tw
WWW: www.asus.com.tw
FTP: ftp.asus.com.tw/pub/ASUS

ASUS COMPUTER INTERNATIONAL (America)

Marketing

Address: 6737 Mowry Avenue, Mowry Business Center, Building 2
Newark, CA 94560, USA
Fax: +1-510-608-4555
Email: tmd1@asus.com

Technical Support

Fax: +1-510-608-4555
Email: tsd@asus.com
WWW: www.asus.com
FTP: ftp.asus.com/Pub/ASUS

ASUS COMPUTER GmbH (Europe)

Marketing

Address: Harkortstr. 25, 40880 Ratingen, BRD, Germany
Fax: +49-2102-442066
Email: sales@asuscom.de (for marketing requests only)

Technical Support

Hotline: MB/Others: +49-2102-9599-0 Notebook: +49-2102-9599-10
Fax: +49-2102-9599-11
Support (Email): www.asuscom.de/de/support (for online support)
WWW: www.asuscom.de
FTP: ftp.asuscom.de/pub/ASUSCOM

CONTENTS

1. INTRODUCTION	7
1.1 How This Manual Is Organized	7
1.2 Item Checklist	7
2. FEATURES	8
2.1 ASUS A7V266-EX Motherboard	8
2.1.1 Specifications	8
2.1.2 Connections	9
2.1.2 Performance	10
2.1.3 Intelligence	11
2.2 Motherboard Components	12
2.2.1 Component Locations	13
3. HARDWARE SETUP	14
3.1 Motherboard Layout	14
3.2 Layout Contents	15
3.3 Hardware Setup Procedure	17
3.4 Motherboard Settings	17
3.5 System Memory	25
3.5.1 DDR DIMM Support	25
3.5.2 Memory Installation	26
3.5.3 General DIMM Memo	26
3.6 Central Processing Unit (CPU)	27
3.7 Expansion Cards	28
3.7.1 Installing an Expansion Card	28
3.7.2 Assigning IRQs for Expansion Cards	29
3.7.3 Accelerated Graphics Port (AGP) Pro Slot	30
3.7.4 Advanced Communication Riser (ACR) Slot	30
3.8 Connectors	31
4. BIOS SETUP	43
4.1 Managing and Updating Your BIOS	43
4.1.1 Upon First Use of the Computer System	43
4.1.2 Updating BIOS Procedures	45
4.2 BIOS Setup Program	47
4.2.1 BIOS Menu Bar	48
4.2.2 Legend Bar	48
4.3 Main Menu	50
4.3.1 Primary & Secondary Master/Slave	51

CONTENTS

4.3.2 Keyboard Features	54
4.4 Advanced Menu	56
4.4.1 Chip Configuration	60
4.4.2 I/O Device Configuration	63
4.4.3 PCI Configuration	65
4.5 Power Menu	67
4.5.1 Power Up Control	69
4.5.2 Hardware Monitor	71
4.6 Boot Menu	72
4.7 Exit Menu	74
5. SOFTWARE SETUP	77
5.1 Install Operating System	77
5.2 Start Windows	77
5.3 A7V266-EX Motherboard Support CD	78
5.4 Using the Promise Chip for RAID 0 or 1	80
6. SOFTWARE REFERENCE	89
6.1 Winbond Smart Manager	89
6.2 ASUS PC Probe	93
6.3 Multi-Channel Audio Feature Setup	98
6.4 ASUS Live Update	100
6.5 3Deep Color Tuner	101
6.6 CyberLink PowerPlayer SE	103
6.7 CyberLink VideoLive Mail	104
7. APPENDIX	107
7.1 Modem Riser	107
7.1.1 56K Software Modem	107
7.1.2 Primary/Secondary MR	107
7.1.3 Hardware Installation Procedure	107
7.1.4 Software Setup in Windows 98	108
7.2 Glossary	109
INDEX	113

FCC & DOC COMPLIANCE

Federal Communications Commission Statement

This device complies with FCC Rules Part 15. Operation is subject to the following two conditions:

- This device may not cause harmful interference, and
- This device must accept any interference received, including interference that may cause undesired operation.

This equipment has been tested and found to comply with the limits for a Class B digital device, pursuant to Part 15 of the FCC Rules. These limits are designed to provide reasonable protection against harmful interference in a residential installation. This equipment generates, uses and can radiate radio frequency energy and, if not installed and used in accordance with manufacturer's instructions, may cause harmful interference to radio communications. However, there is no guarantee that interference will not occur in a particular installation. If this equipment does cause harmful interference to radio or television reception, which can be determined by turning the equipment off and on, the user is encouraged to try to correct the interference by one or more of the following measures:

- Re-orient or relocate the receiving antenna.
- Increase the separation between the equipment and receiver.
- Connect the equipment to an outlet on a circuit different from that to which the receiver is connected.
- Consult the dealer or an experienced radio/TV technician for help.

WARNING! Any changes or modifications to this product not expressly approved by the manufacturer could void any assurances of safety or performance and could result in violation of Part 15 of the FCC Rules.

Reprinted from the Code of Federal Regulations #47, part 15.193, 1993. Washington DC: Office of the Federal Register, National Archives and Records Administration, U.S. Government Printing Office.

Canadian Department of Communications Statement

This digital apparatus does not exceed the Class B limits for radio noise emissions from digital apparatus set out in the Radio Interference Regulations of the Canadian Department of Communications.

This Class B digital apparatus complies with Canadian ICES-003.

Cet appareil numérique de la classe B est conforme à la norme NMB-003 du Canada.

1. INTRODUCTION

1.1 How This Manual Is Organized

This manual is divided into the following sections:

1. INTRODUCTION	Manual information and checklist
2. FEATURES	Production information and specifications
3. HARDWARE SETUP	Instructions on setting up the motherboard.
4. BIOS SETUP	Instructions on setting up the BIOS
5. SOFTWARE SETUP	Instructions on setting up the included software
6. SOFTWARE REFERENCE	Reference material for the included software
7. APPENDIX	Optional items and general reference

1.2 Item Checklist

Check that your package is complete. If you discover damaged or missing items, contact your retailer.

Package Contents

- (1) ASUS Motherboard
- (1) 40-pin 80-conductor ribbon cable for internal UltraDMA100/66//33 IDE drives
- (1) Ribbon cable for two 3.5" floppy disk drives
- (1) ASUS Support CD with drivers and utilities
- (1) Bag of spare jumper caps
- (1) ASUS 2-port USB Connector Set
- (1) User's Manual

Optional Items

- ASUS IrDA-compliant infrared module

2. FEATURES

2.1 ASUS A7V266-EX Motherboard

The ASUS A7V266-EX motherboard is the perfect answer for home PCs, workstations and servers. The A7V266-EX is powered by the AMD® Athlon™/Duron™ processor and is bundled with advanced features to provide superlative performance.

2.1.1 Specifications

- **AMD® Athlon™/ Athlon XP™ and Duron™ Processor Support**
- **North Bridge System Chipset:** Features the VIA® KT266A North Bridge that supports AGP 4X/2X mode, 133/100MHz Front Side Bus (FSB), and 266/200MHz memory bus.
- **South Bridge System Chipset:** VIA® VT8233A integrated peripheral controller supports UltraDMA133/100/66/33 for burst mode data transfer rates of up to 133MB/sec, and USB controller with two root hubs for four USB ports.
- **PC2100 / PC1600 DDR Support:** Equipped with three Double Data Rate Dual Inline Memory Module (DDR DIMM) sockets to support up to 3GB of DDR DRAM. DDR DRAM is the newest memory standard with the highest bandwidth and lowest latency currently available. DDR dramatically improves the memory system's ability to service, among others, high multimedia requirements. (*Caution:* Do not attempt to use SDRAM modules.)
- **JumperFree™ Mode:** Make processor settings to overclock frequency and Vcore voltage through BIOS. Easy-to-use DIP switches come with the motherboard board for manual adjustment of processor frequencies.
- **UltraDMA/133 Support:** Comes with an onboard PCI Bus Master IDE controller with two connectors that support four IDE devices on two channels. Supports UltraDMA133/100/66/33, PIO Modes 3 & 4, Bus Master IDE DMA Mode 2, and Enhanced IDE devices: DVDs, CD-R/RW, LS-120, and Tape Backup drives.
- **Super Multi-I/O:** The multi-I/O chipset offers complete support for a variety of I/O functions. Provides two high-speed UART compatible serial ports and one parallel port with EPP and ECP capabilities. UART2 can also be directed from COM2 to the Infrared Module for wireless connections. The Super I/O controller also supports a floppy disk drive, PS/2 keyboard, and PS/2 mouse.
- **Optional Promise® chip:** The Promise IDE controller chip supports the ATA-133 protocol and Ultra DMA/133 data transfer speeds. The chip also delivers reliable redundancy and stable performance for RAID levels 0 or 1. Data "striping," RAID 0, improves *speed performance* as I/O tasks are spread between two hard disk drives. Data "mirroring," RAID 1, improves system fault tolerance by optimizing two identical hard disks to write data to each other.
- **C.O.P. Thermal Protection:** With AMD® Athlon XP™ installed, the motherboard offers users ASUS C.O.P. automatic CPU Overheating Protection to prolong the life of the entire system. If the CPU temperature becomes excessive, the PC shuts down automatically.

2. FEATURES

- **Smart BIOS:** 2Mb firmware enables Vcore and CPU/DDR SDRAM frequency adjustments, boot block write protection, and HD/SCSI/MO/ZIP/CD/Floppy boot selection.

2.1.2 Connections

- **CPU socket:** Socket A (462) for AMD® processors.
- **PCI Expansion Slots:** Provides five 32-bit Legacy Free PCI slots, (PCI 2.2 compliant) with no ISA, eliminating bottlenecks and system memory management issues. All PCI slots can support Bus Master PCI cards, such as SCSI or LAN cards. (PCI supports up to 133MB/s maximum throughput.) The MB supports Concurrent PCI, which allows multiple PCI transfers from PCI master bus to the memory and processor.
- **IDE connectors:** Dual-channel bus master IDE connectors support up to four Ultra DMA133/100/66, PIO Modes 3 & 4 IDE devices like two HDDs, one DVD and an R/W CD.
- **AGP Pro Slot:** Comes with an Accelerated Graphics Port Pro slot that supports AGP cards for high performance, component level interconnect targeted at 3D graphical applications using a 4X mode bus. The slot is keyed to support only the latest 1.5 volt AGP cards.
- **Floppy disk connector:** Supports the floppy disk drive.
- **Wake-On-LAN:** Supports Wake-On-LAN activity through an optional ASUS PCI-L101 10 /100 Fast Ethernet PCI card.
- **Wake-On-Ring:** Supports Wake-On-Ring activity through a PCI modem card.
- **Smartcard Reader Connector:** Supports a PS/SC compatible Smart Card
- **USB ports:** Two Universal Serial Bus (USB) ports are available for connecting USB devices such as a mouse and PDA.
- **Serial ports:** Two 9-pin COM1/COM2 ports are for all serial devices.
- **IrDA:** Supports an optional infrared port module for a wireless interface.
- **Microphone:** Pink jack connects a microphone (or 6 channel speaker).
- **Line In:** Light blue jack connects a tape player (or 6 channel speaker).
- **Line Out:** Lime jack connects a headphone, a speaker (or 6 channel speaker).
- **Game/MIDI connector.** This connector supports a joystick or a game pad for playing games, and MIDI devices for playing or editing audio files.
- **Parallel port:** 25-pin port connects a parallel printer or other devices.
- **PS/2 mouse port:** Green 6-pin connector is for a PS/2 mouse.
- **PS/2 keyboard port:** Purple 6-pin connector is for a PS/2 keyboard.
- **Onboard LED:** Signals AC power is okay.
- **ATX power connector.** Supplies the MB with ATX 12V power. The power supply must have at least 1A on the +5V standby lead (+5VSB).

2. FEATURES

2.1.2 Performance

- **DDR DRAM Optimized Performance:** This motherboard supports a new generation memory, Double Data Rate (DDR) Dynamic Random Access Memory (DDR DRAM). This new memory technology increases performance by executing two actions per clock cycle, resulting in data transfer rates of up to 2.1 GB/s for 133MHz DDR SDRAM and 1.6GB/s for 100MHz DDR SDRAM.
- **Onboard Audio:** Audio models come with the six-channel C-Media CMI8738 PCI audio controller that supplies HRTF 3D positional audio functions. The chip supports software access to PC DVD 5.1/6.1 and AC-3/DTS via SPDIF. Other integrative features include: full DVD playback, PCtel 56K modem, and even Karaoke echo effects. The chip offers 24-bit SPDIF digital recording and playback with additional support for legacy audio SBPRO™ and FM emulator/DLS wavetable music synthesis. A software package helps setup the multi-channel PC sound system.
- **ACPI Ready:** Advanced Configuration Power Interface (ACPI) provides more Energy Saving Features for operating systems that support OS Direct Power Management (OSPM) functionality. With these features employed in the OS, PCs can be ready around the clock but comply with energy saving standards. To fully utilize the ACPI benefits, use an ACPI-supported OS such as Windows 98.
- **Smartcard Reader Connector:** This connector that provides the convenience of PS/SC compatible Smart Card security plus support for a multitude of new financial, telephonic, and mobile access services.
- **PC'99 Compliant:** Both the BIOS and hardware levels of ASUS smart series motherboards are PC'99 compliant. The new PC'99 requirements for systems and components are based on the following high-level goals: Support for Plug-n-Play compatibility and power management for configuring and managing all system components, and 32-bit device drivers and installation procedures for Windows95/98/NT. Color-coded connectors and descriptive icons make identification easy as required by PC'99.
- **High-Speed Data Transfer Interface:** Support for UltraDMA/133 through the onboard IDE bus master controller quadruples the UltraDMA/33 burst transfer rate. UltraDMA/133 is backward compatible with DMA100/66/33, and other existing DMA devices to save the need to upgrade current EIDE/IDE drives. (UltraDMA/66 requires a 40-pin 80-conductor cable).
- **Concurrent PCI:** Concurrent PCI allows multiple PCI transfers from PCI master busses to the memory and processor.

2. FEATURES

2.1.3 Intelligence

- **Auto Fan Off:** The system fans powers off automatically even in sleep mode. This function reduces both energy consumption and system noise, and is an important feature in implementing silent PC systems.
- **Dual Function Power Button:** Pushing the power button for less than 4 seconds when the system is in the working state places the system into one of two states: sleep mode or soft-off mode, depending on the BIOS or OS setting (*See PWR Button < 4 Secs in 4.5 Power Menu*). When the power button is pressed for more than 4 seconds, the system enters the soft-off mode regardless of the BIOS setting.
- **Fan Status Monitoring and Alarm:** To prevent system overheat and system damage, the CPU and system fans can be monitored for RPM and failure. All fans are set for its normal RPM range and alarm thresholds.
- **Power LED (requires ACPI OS support):** The power LED indicates the system status.
- **Remote Ring-On (requires modem):** This allows a computer to be turned on remotely through an internal or external modem. With this benefit on-hand, users can access vital information from their computers anywhere.
- **Temperature Monitoring and Alert:** CPU temperature is monitored by the ASUS ASIC through the CPU's internal thermal diode (on Pentium III and Celeron) to prevent system overheat and system damage.
- **Voltage Monitoring and Alert:** System voltage levels are monitored to ensure stable voltage to critical motherboard components. Voltage specifications are more critical for future processors, so monitoring is necessary to ensure proper system configuration and management.
- **Chassis Intrusion Detection:** Supports chassis-intrusion monitoring through the ASUS ASIC. A chassis intrusion event is kept in memory on battery power for more protection.

2. FEATURES

2.2 Motherboard Components

See opposite page for locations.

	Location
Processor Support	Socket A for AMD® Athlon™ XP and Duron™ Processors 2
	Feature Setting DIP Switches 8
Chipsets	VIA® KT266A North Bridge 1
	VIA® VT8233A South Bridge 13
	Promise IDE / RAID controller 7
	ASUS System Monitor controller 9
	Multi-I/O controller 22
	2Mbit Programmable Flash EEPROM 21
Main Memory	Maximum 3GB support
	3 DDR DIMM Sockets 3
Expansion Slots	5 PCI Slots 19
	1 Accelerated Graphics Port (AGP) Pro/4X Slot 24
	1 Advanced Communication Riser 16
System I/O	1 Floppy Disk Drive Connector 14
	2 IDE Connectors (ATA-133 / Promise RAID Support) 5
	2 IDE Connectors (ATA-133 Support) 6
	1 Panel Connector 10
	1 Afp panel Connector 11
	1 Infrared Connector 12
	1 Smart Card Connector 20
	1 Parallel Port 26
	2 Serial Ports (COM1/COM2) 31
	USB Connectors (Port 0 & Port 1) 32
	USB Headers (Ports 2/3) 15
	1 PS/2 Mouse Connector (Green) 25
	1 PS/2 Keyboard Connector (Purple) 33
Hardware Monitoring	System Voltage Monitoring (integrated in ASUS ASIC) 9
Special Feature	Onboard LED 23
Audio Features	<i>(Audio models only)</i>
	CMI8738 6-Channel Audio Controller 17
	1 ASUS iPanel Audio Connector 18
	1 Game/MIDI Port 27
	1 Line Out Connector (Lime) 30
	1 Line In Connector (Light blue) 29
	1 Microphone Connector (Pink) 28
	Internal Audio Connectors
Power	ATX Power Supply Connector 4
Form Factor	ATX

2. FEATURES

2.2.1 Component Locations

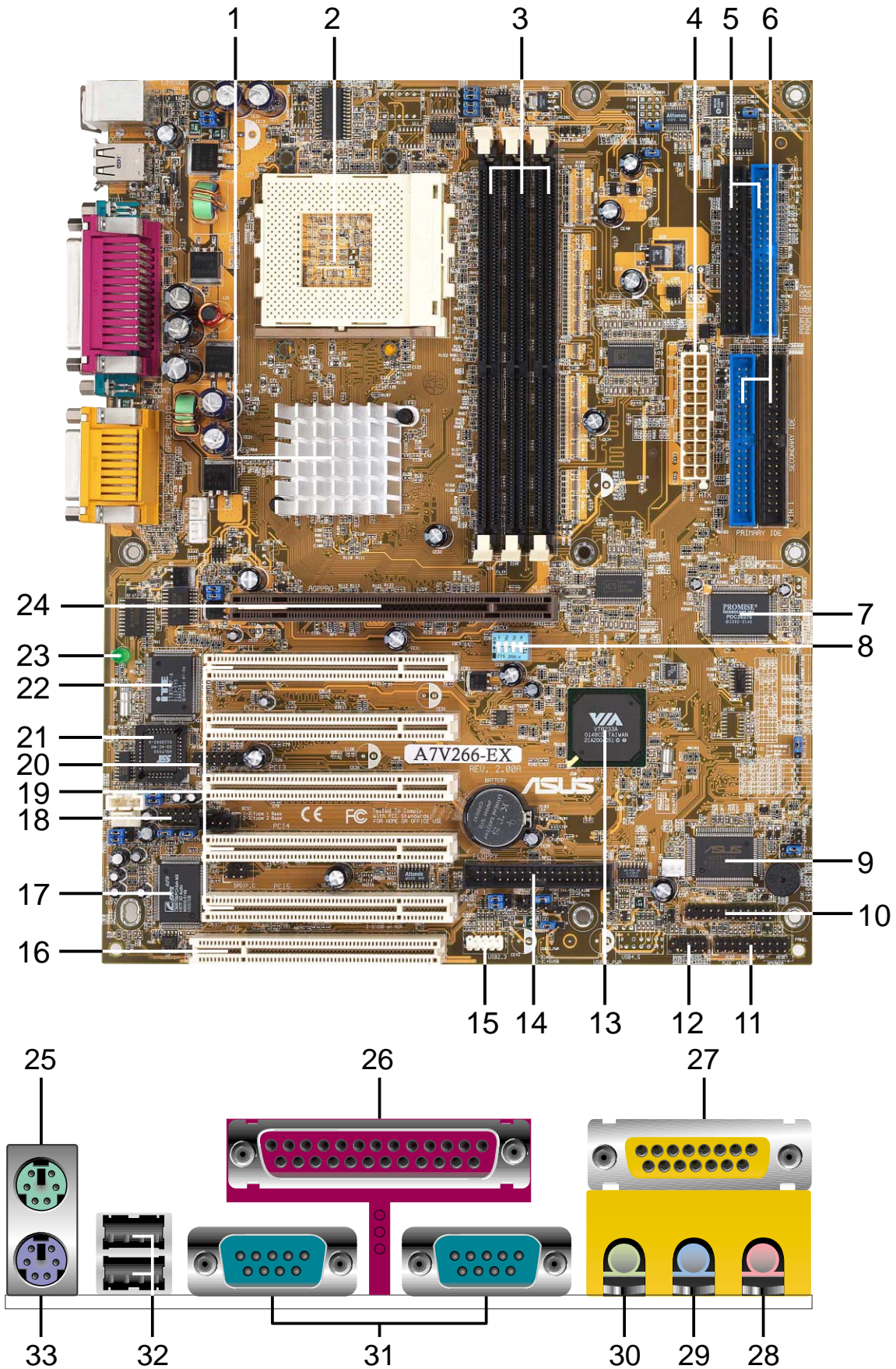

2. FEATURES
Motherboard Parts

3. HARDWARE SETUP

3.1 Motherboard Layout

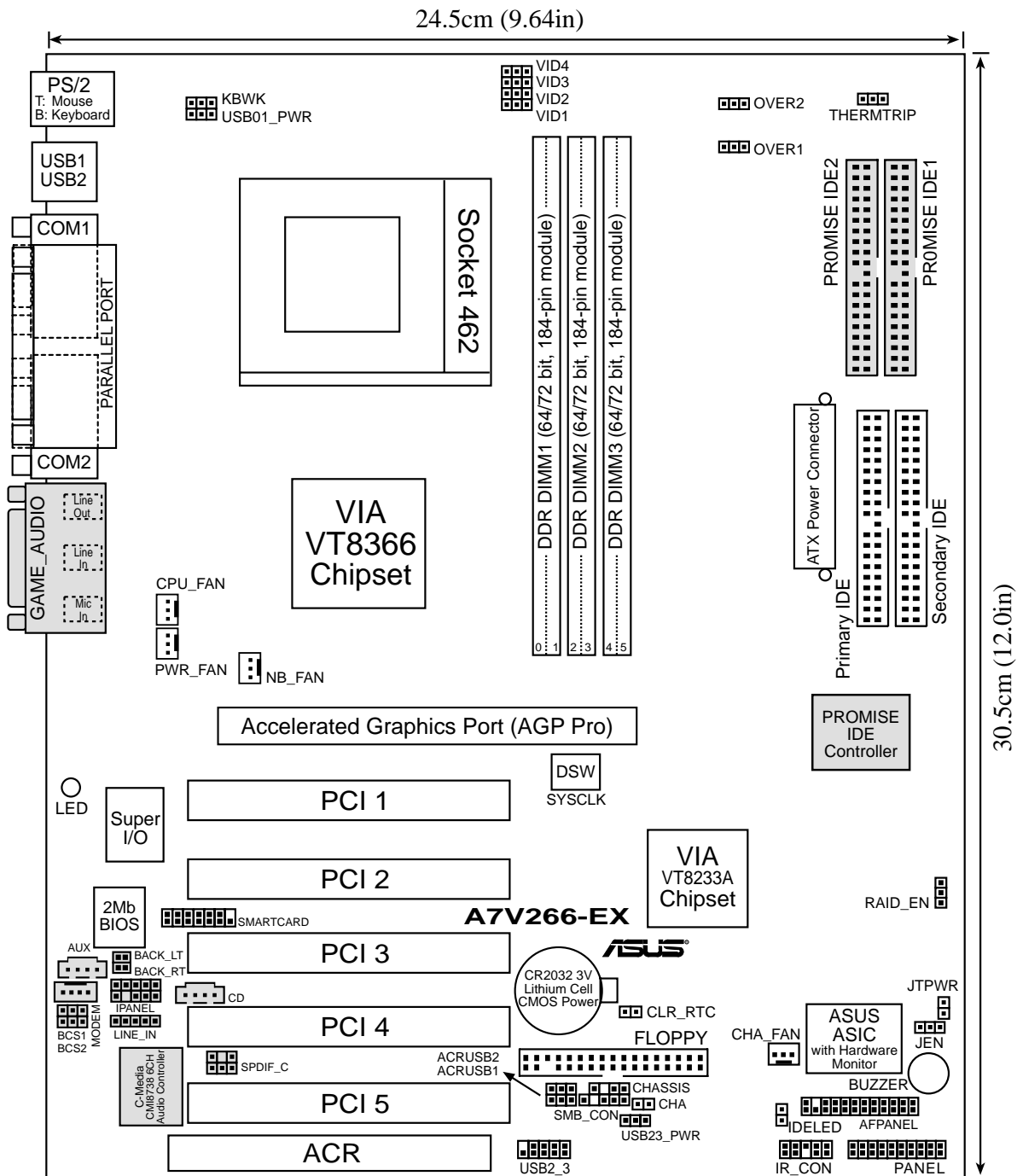

(Grayed components are optional.)

3. HW SETUP
Motherboard Layout

3. HARDWARE SETUP

3.2 Layout Contents

Motherboard Settings

- | | |
|---------------------|--|
| 1) JEN | p. 18 JumperFree Mode Setting (Disable / Enable) |
| 2) DIP_SW | p. 19 CPU External Frequency Selection (Switches 1–4) |
| 3) DSW | p. 20 Manual CPU Ratio Settings (Switches 1-5) |
| 4) VID1, 2, 3, 4 | p. 21 Voltage Regulator Output Volt. Setting (1.675V-1.85 V) |
| 5) BCS | p. 21 Bass Center Setting (Center/Bass, Bass/Center) |
| 6) KBWK | p. 22 Keyboard Power Up (Enable / Disable) |
| 7) ACRUSB1, ACRUSB2 | p. 22 ACR/USB Selection (USB to Conn. / USB on ACR) |
| 8) USB01, 23_PWR | p. 23 Two USB Device Wake-ups (+5V / +5VSB) |
| 9) RAID_EN | p. 23 IDE Channel Setting (ATA133 or RAID 1/0) (<i>Optional</i>) |
| 10) CLR_RTC | p. 24 Clear RTC RAM (2 pin contact) |
| 11) THEMCPU | p. 24 Thermal Sensor CPU Setting (Athlon-Duron / Reserved) |

Expansion Slots/Sockets

- | | |
|------------------|---|
| 1) DIMM 1/2/3 | p. 25 System Memory Support |
| 2) Socket 462 | p. 27 CPU Support |
| 3) PCI 1/2/3/4/5 | p. 28 32-bit PCI Bus Expansion Slots |
| 4) AGP Pro | p. 30 Accelerated Graphics Port Slot |
| 5) ACR Slot | p. 30 Advanced Communication Riser Slot |

Connectors

- | | |
|------------------------|---|
| 1) PS2KBMS | p. 31 PS/2 Mouse Port (6 pin female) |
| 2) PS2KBMS | p. 31 PS/2 Keyboard Port (6 pin female) |
| 3) USB | p. 32 Universal Serial Bus Ports 1 & 2 (Two 4 pin female) |
| 4) PRINTER | p. 32 Parallel Port (25 pin female) |
| 5) COM1/COM2 | p. 32 Serial Ports (9 pin /10-1 pin male) |
| 6) GAME_AUDIO | p. 33 Game/MIDI Port (15-pin female) (<i>optional</i>) |
| 7) AUDIO | p. 33 Audio Connectors (Three 1/8" AUDIO) (<i>optional</i>) |
| 8) IDELED | p. 34 IDE Activity LED (2 pin) |
| 9) FLOPPY | p. 34 Floppy Disk Drive Connector (34 pin) |
| 10) PRIMARY / SEC. IDE | p. 35 IDE Connectors (Two 40-1 pin) |
| 11) CPU/PWR/CHA_FAN | p. 36 CPU, Power, and Chassis Fan Connectors (Three 3 pin) |
| 12) USB2_3 | p. 36 USB Header (10-1 pin) |
| 13) IR_CON | p. 37 Standard Infrared Module Connector (10-1 pin) |
| 14) AFPANEL | p. 37 ASUS iPanel Connector (12-1 pin) |
| 15) ATXPWR | p. 38 ATX Power Supply Connector (20 pin) |

3. HARDWARE SETUP

16) SMB	p. 38 SMBus Connector (5-1 pin)
17) CD/AUX/MODEM	p. 39 Internal Audio Connectors (Three 4-1 pin) (<i>optional</i>)
18) JTPWR	p. 39 Power Supply Thermal Sensor Connector (2 pin)
19) SPDIFOUT / CDSPDIFIN	p. 40 Digital audio Interfaces (2 pin) (<i>optional</i>)
20) CHASSIS	p. 40 Chassis Intrusion Lead (2 pin)
21) IPANEL	p. 41 ASUS iPanel Audio Connector (10-1 pin)
22) SMARTCON	p. 41 ASUS SmartCard Connector (14-1 pin)
23) BACK_LT/BACK_RT	p. 42 ASUS Internal Line Out Connector (14-1 pin)
24) PWR.LED (PANEL)	p. 43 System Power LED Lead (3 pin)
25) KEYLOCK (PANEL)	p. 43 System Keyboard Lock Switch Lead (2 pin)
26) SPEAKER (PANEL)	p. 43 System Warning Speaker Lead (4 pin)
27) MSG.LED (PANEL)	p. 43 System Message LED Lead (2 pin)
28) SMI (PANEL)	p. 43 System Management Interrupt Lead (2 pin)
29) PWR.SW (PANEL)	p. 43 ATX / Soft-Off Switch Lead (2 pin)
30) RESET (PANEL)	p. 43 Reset Switch Lead (2 pin)

3. HARDWARE SETUP

3.3 Hardware Setup Procedure

Complete the following steps before using your computer:

1. Check motherboard settings
2. Install memory modules
3. Install the Central Processing Unit (CPU)
4. Install Expansion Cards
5. Connect ribbon cables, panel wires, and power supply cables
6. Configure the BIOS parameter settings

3.4 Motherboard Settings

This section tells you how to change motherboard function settings through the switches and/or jumpers.

WARNING! Computer motherboards and expansion cards contain very delicate Integrated Circuit (IC) chips. To avoid damaging them due to static electricity, follow these precautions whenever you work on your computer.

1. Unplug the computer when working on the internal components.
2. Use a grounded wrist strap or touch a safely grounded object or to a metal object, such as the power supply case, before handling computer components.
3. Hold components by the edges and try not to touch the IC chips on them.
4. Whenever you uninstall any component, place the components on a grounded antistatic pad or in the bag that came with the components.
5. **Before you install or remove any component, ensure that the ATX power supply is switched off or the power cord is detached from the power supply.** Failure to do so may cause severe damage to the motherboard, peripherals, and/or components.

(**TIP:** When lit, the onboard LED indicates that the system is in suspend or soft-off mode, not powered OFF. See illustration below.)

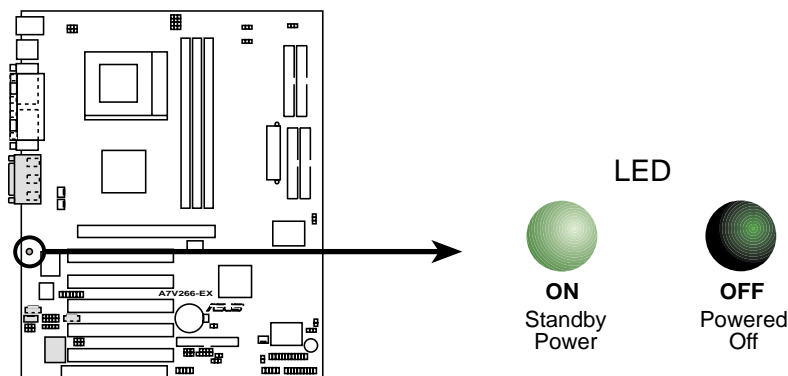

A7V266-EX Onboard LED

3. HARDWARE SETUP

Motherboard Frequency Settings (DIP Switches)

The motherboard frequency is adjusted through the DIP switches. The white block represents the switch's position. The illustration below shows all the switches in the OFF position.

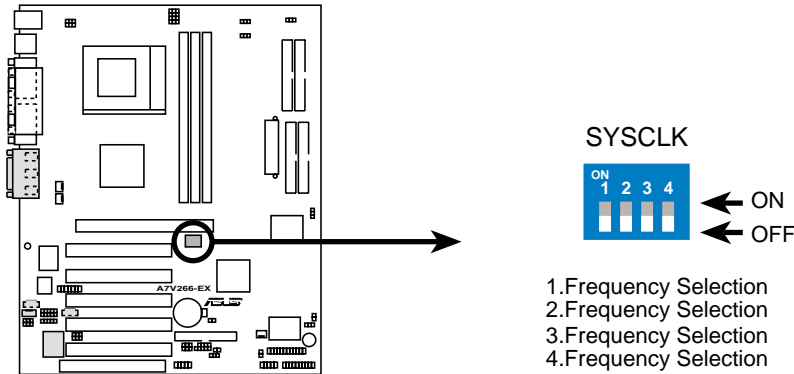

A7V266-EX DIP Switch

- 1.Frequency Selection
- 2.Frequency Selection
- 3.Frequency Selection
- 4.Frequency Selection

3. HW SETUP
Motherboard Settings

1) JumperFree™ Mode (JEN)

This jumper allows you to enable or disable the JumperFree™ mode. The JumperFree™ mode allows processor settings to be made through the BIOS setup (see *4.4 Advanced Menu*).

Setting	JEN
Enable (JumperFree)	[2-3] (default)
Disable (Jumper Mode)	[1-2]

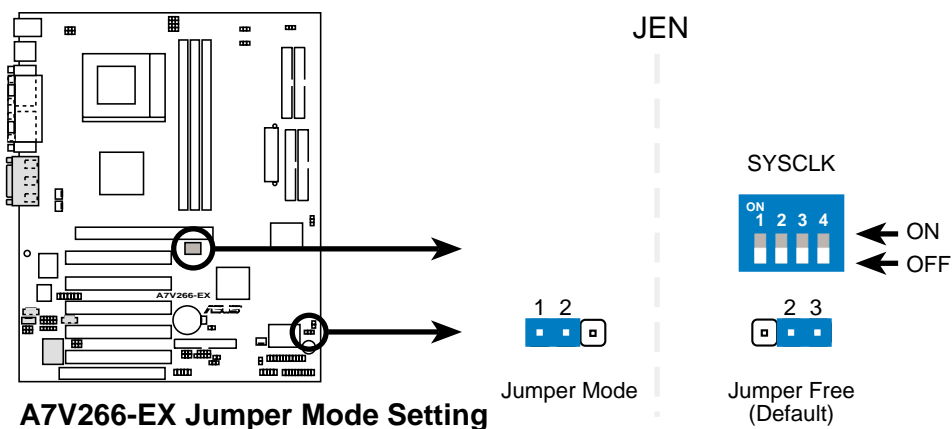

A7V266-EX Jumper Mode Setting

NOTE: By default for JumperFree™ mode all SYSCLK switches are set: OFF.

3. HARDWARE SETUP

2) CPU External Frequency Selection (DIP_SW Switches 1–4)

This option tells the clock generator what frequency to send to the CPU, DRAM, and the PCI bus. This allows the selection of the CPU's *External* frequency (or *BUS Clock*). The BUS Clock multiplied by the Frequency Multiple equals the CPU's *Internal* frequency (the advertised CPU speed).

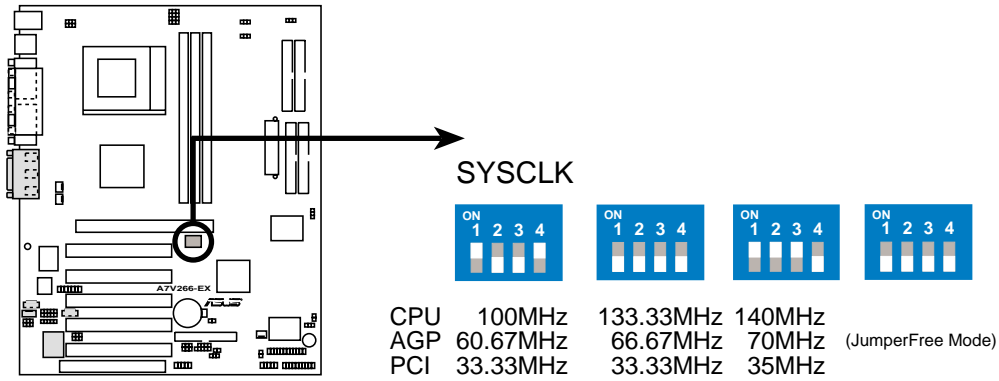

A7V266-EX CPU External Frequency Selection

WARNING! Set the CPU frequency only to the recommended settings. Frequencies other than the recommended CPU bus frequencies are not guaranteed to be stable. Overclocking the processor is not recommended. It may result in a slower speed.

3. HARDWARE SETUP

3) Voltage Over Setting (OVER1, OVER2)

This jumper opens or closes the circuit to control the use of voltage increases to enhance CPU performance. The default setting, [2-3] disables the use of “over-voltage” increases. Switch the jumper cap to [1-2] before attempting changes with the VID jumpers. NOTE: It is not recommended to use this feature unless confident that the CPU will not be damaged.

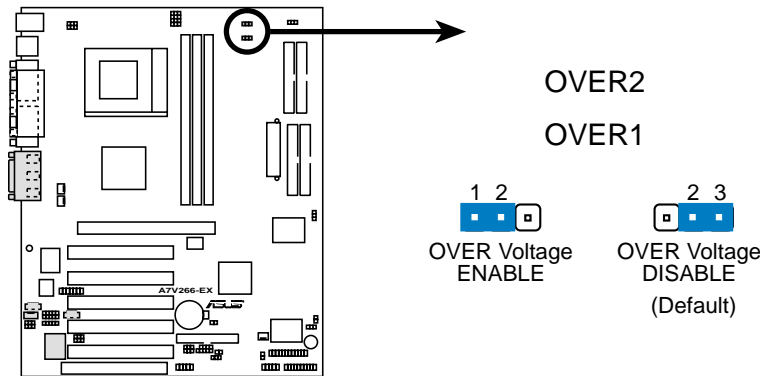

A7V266-EX OVER Voltage Selection

4) Voltage Regulator Output Setting (VID1, VID2, VID3, VID4)

This jumpers allow you to manually adjust the CPU core voltage. It is recommended to use **CPU Default** as the CPU core voltage. **CPU Default**, all jumpers [2-3], means the Vcore is generated according to the CPU VID configuration. For each jumper setting, there are two voltage options, depending on the CPU used.

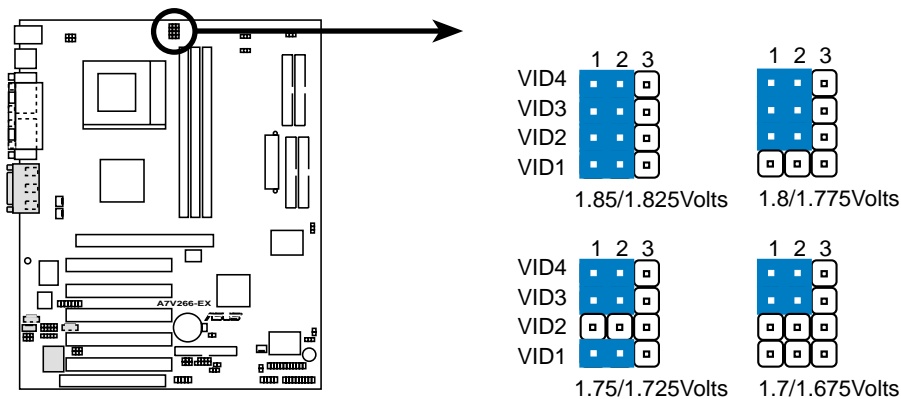

A7V266-EX CPU Core Voltage Selection

3. HARDWARE SETUP

5) Bass Center Setting (CENTER/BASS, BASS/CENTER)

Use these jumpers in conjunction with the C-Media PCI Audio Driver and to adjust output for 4 or 6 speaker audio. No audio standard exists for the three pick-up surfaces on male audio jacks, therefore it may be necessary to switch jumpers from the default position, Center/Bass [1-2] to Bass/Center [2-3] in order to help reroute signals among the internal leads in the Line-In, Line-Out, Mic female sockets. Make a test is made using the C-Media Audio Driver software setup available on the Support CD.

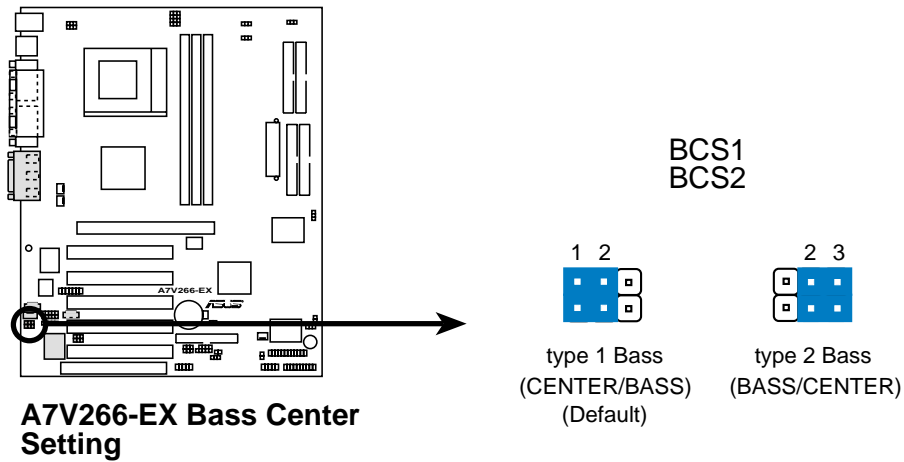

3. HARDWARE SETUP

6) Keyboard Wake Up (KBWK)

This allows you to disable or enable the keyboard power up function. Set this jumper to *Enable* if you wish to use your keyboard (by pressing <Spacebar>) to power up your computer. This feature requires an ATX power supply that can supply at least 300mA on the +5VSB lead. The default is set to *Enable*. (The computer will not power ON if you set this to *Enable* but do not have the correct ATX power supply. **NOTE:** This jumper must be set in conjunction with **Wake On PS2 KB/PS2 Mouse/CIR** in **4.5.1 Power Up Control**.)

<u>Setting</u>	<u>KBWK</u>
Enable	[1-2] (default)
Disable	[2-3]

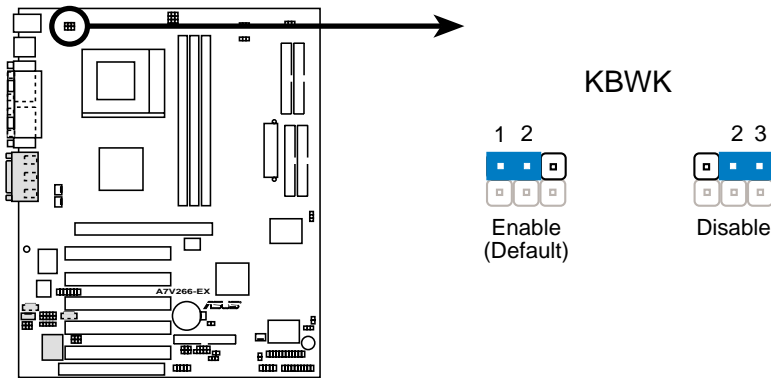

A7V266-EX Keyboard Wake Up

7) ACR/USB Selection (ACRUSB1, ACRUSB2) (audio models only)

When set to pins 1-2, these jumpers allow you to activate USB port 3. Setting the jumpers to pins 2-3 activates the Advanced Communication Riser (ACR) slot. The default setting for both jumpers is 1-2. (NOTE: The USB port 2 is always active regardless of the setting of these jumpers.)

IMPORTANT! Always set both jumpers accordingly when selecting a device.

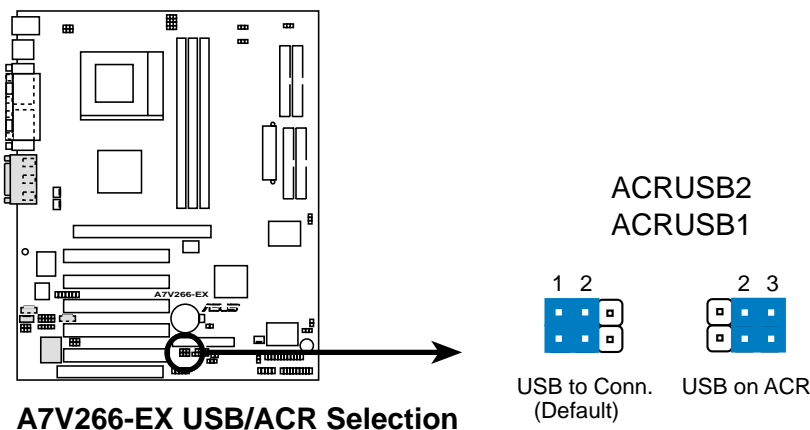

A7V266-EX USB/ACR Selection

3. HARDWARE SETUP

8) USB Device Wake-up (USB01_PWR/USB23_PWR/USB45_PWR)

Set these jumpers to +5V to allow wake up from the S1 sleep state (CPU stopped; RAM refreshed; system running in low power mode) using the connected USB devices. Set to +5VSB to allow wake up from S3 sleep state (no power to CPU; RAM in slow refresh; power supply in reduced power mode). The default setting for the three jumpers is 1-2 to select +5V (because not all computers have the appropriate power supply).

NOTES:

1. This feature requires an ATX power supply that can supply at least 2A on the +5VSB lead when these jumpers are set to +5VSB. Otherwise, the system does not power up.
2. The total current consumed must NOT exceed the power supply capability (+5VSB) whether under normal working conditions or in sleep mode.

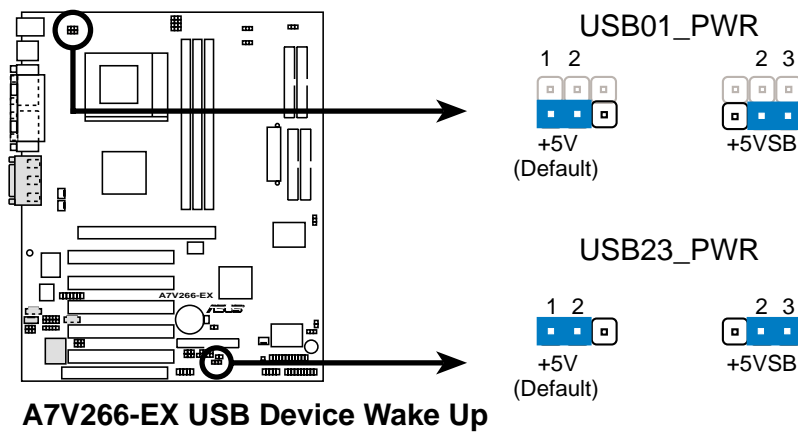

A7V266-EX USB Device Wake Up

9) Promise RAID Controller (RAID_EN) (Optional)

These jumpers enable the Promise RAID controller functions. The default setting, [1-2] enables the Promise RAID controller for RAID0/1. Resetting the jumper caps to [2-3] overrides the Promise controller. The IDE controller always functions at ATA-133 for hard disk drives whether or not the RAID controller is activated or not.

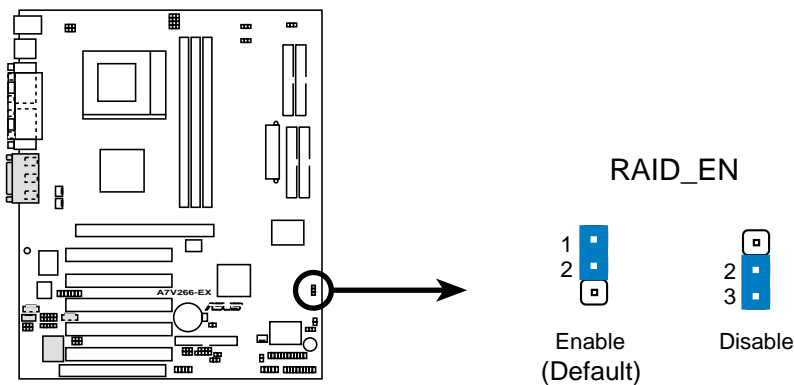

A7V266-EX ATA133/RAIDO Selection

3. HARDWARE SETUP

10) Clear RTC RAM (2-pin CLR_RTC)

This jumper allows you to clear the Real Time Clock (RTC) RAM in CMOS. You can clear the CMOS memory of date, time, and system setup parameters by erasing the CMOS RTC RAM data. The RAM data in CMOS, that include system setup information such as system passwords, is powered by the onboard button cell battery.

To erase the RTC RAM:

1. Turn OFF the computer and unplug the power cord.
2. Remove the battery.
3. Short the jumper by removing and replacing the jumper cap.
4. Re-install the battery.
5. Plug the power cord and turn ON the computer.
6. Hold down the key during the boot process and enter BIOS setup to re-enter data.

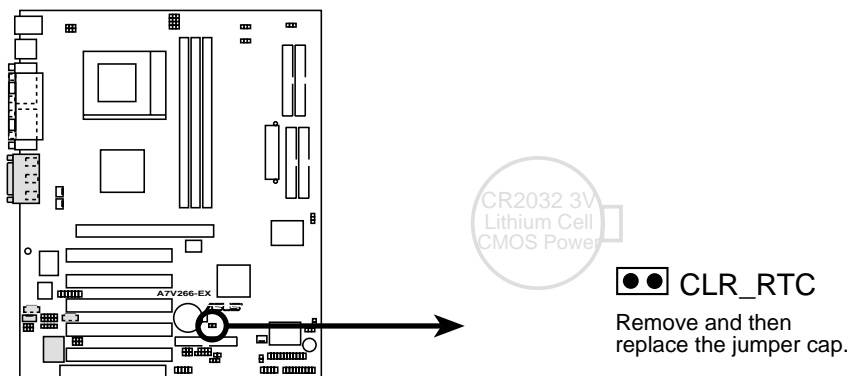

A7V266-EX Clear RTC RAM

11) Thermal Sensor CPU Setting (2-pin THERMTRIP)

This jumper selects the type of CPU and coordinates its thermal sensory capability. The default setting, [2-3] for Palimino/Reserve type processors, and [1-2] is for Athlon/Duron processors.

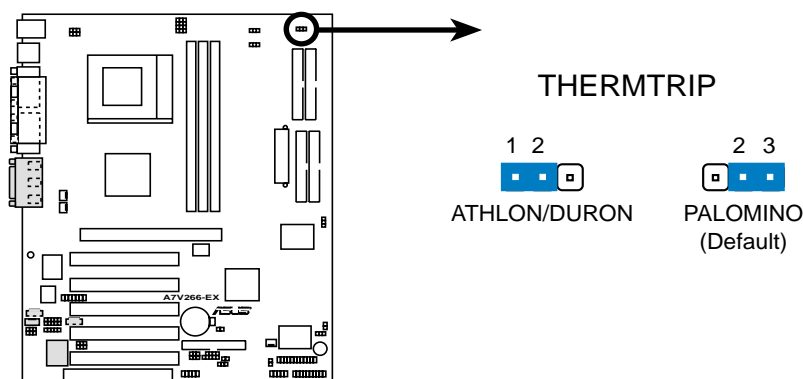

A7V266-EX THERMTRIP Setting

3. HARDWARE SETUP

3.5 System Memory

This motherboard uses only **Double Data Rate (DDR)** Synchronous Dynamic Random Access Memory (SDRAM) Dual Inline Memory Modules (DIMMs).

3.5.1 DDR DIMM Support

DIMMs come in combinations of single or double-sided types ranging through 64MB, 128MB, 256MB, 512MB and 1GB to form a total memory size of *64MB to 3GB*.

Each DIMM socket/module is two-sided: each side comprises one “row” of memory.

~ **Three (3)** sockets are available for 266MHz-PC2100 / 200MHz-PC1600 **unbuffered** DDR DIMMs: to form a memory size of *64MB to 3GB*.

NOTE: The DDR memory bus runs at the same frequency as the CPU front side bus.

Install memory in any combination as follows:

DIMM Location	184-pin DDR DIMM	Total Memory
Socket 1 (Rows 0&1)	64MB, 128MB, 256MB, 512MB, 1GB	x1
Socket 2 (Rows 2&3)	64MB, 128MB, 256MB, 512MB, 1GB	x1
Socket 3 (Rows 4&5)	64MB, 128MB, 256MB, 512MB, 1GB	x1
Total System Memory (Max 3GB)		=

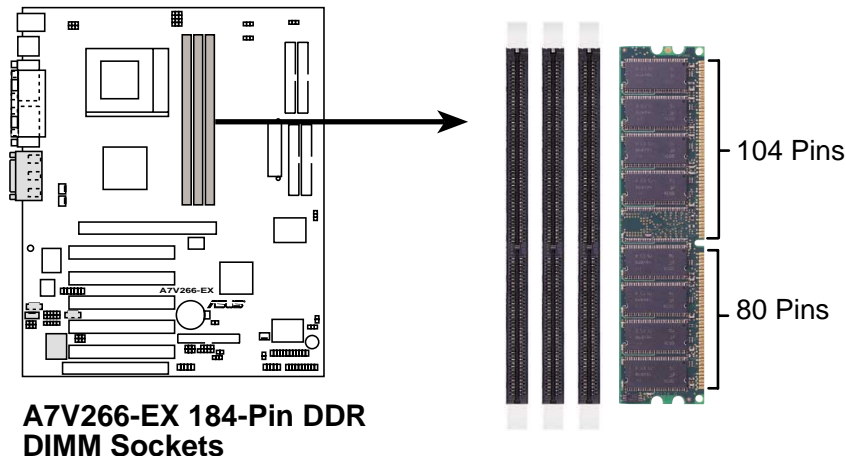

WARNING! Be sure that the DIMMs you use can handle the specified DDR RAM MHz or else bootup will not be possible.

3. HARDWARE SETUP

3.5.2 Memory Installation

WARNING! Make sure that you unplug your power supply when adding or removing memory modules or other system components. Failure to do so may cause severe damage to both your motherboard and expansion cards

Insert the module(s) as shown. Because the number of pins are different on either side of the breaks, the module will only fit in the orientation shown. A 184-pin DDR SDRAM DIMM has a single notch slightly to the right of center. This motherboard supports three pairs of differential clock signals per DIMM.

Installing a DIMM:

1. Unlock a DIMM socket by pressing the retaining clips outward.
2. Align a DIMM on the socket such that the notches on the DIMM exactly match the notches in the socket.
3. Firmly insert the DIMM into the socket until the retaining clips snap back in place.

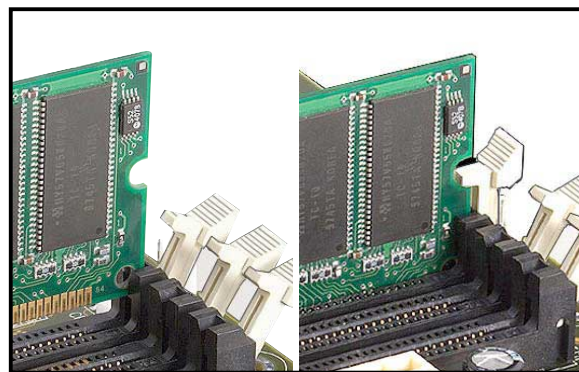
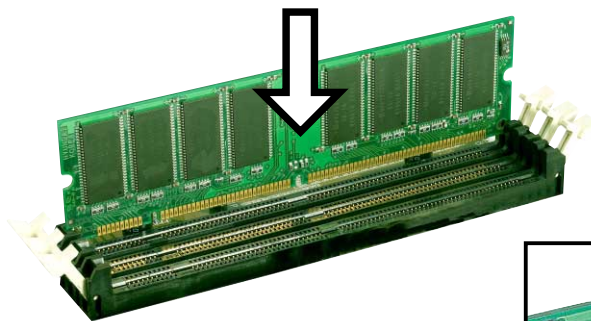

Unlocked Retaining Clip Locked Retaining Clip

3.5.3 General DIMM Memo

- **DIMMs that have more than 18 chips are not supported on this motherboard.**
- **For the system CPU bus to operate at 200MHz/266MHz, use only PC1600-/PC2100-compliant DIMMs.**
- ASUS motherboards support SPD (Serial Presence Detect) DIMMs. This is the memory of choice for best performance vs. stability.
- Single-sided DDR DIMMs come in 64, 128, and 256MB; double-sided come in 128, 256, and 512MB.

3. HARDWARE SETUP

3.6 Central Processing Unit (CPU)

The motherboard provides a Socket 462 or Socket A for CPU installation. A fan and heatsink should be attached to the CPU to prevent overheating. Purchase and install a fan and heatsink before turning on the system.

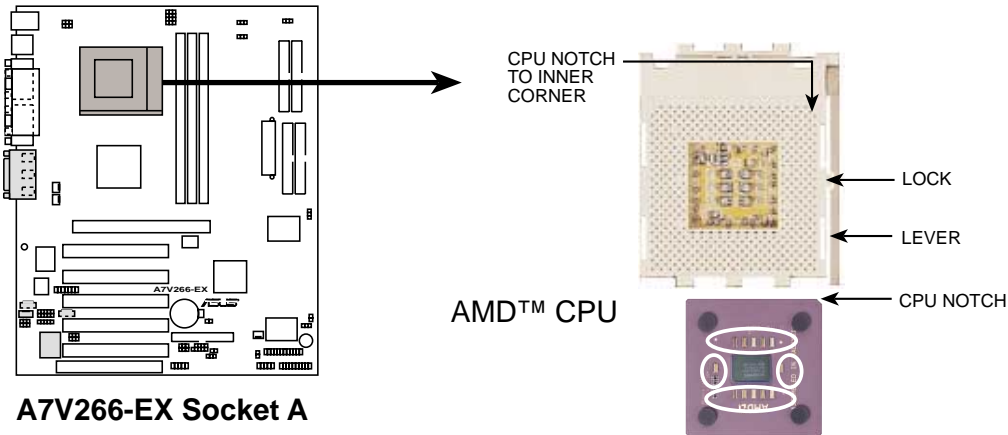

1. Locate the Socket 462 and open it by pulling the lever gently sideways away from the socket. Then lift the lever upwards. The socket lever must be fully opened (90 to 100 degrees).
2. Insert the CPU with the correct orientation. The *notched corner* of the CPU must be oriented toward the inner corner of the socket base nearest to the lever hinge.

CAUTION! The CPU fits in one orientation and should drop easily into place. *Do not force the CPU* into the socket to avoid bending the pins. If the CPU does not fit, check its alignment and look for bent pins.

3. Once completely inserted, press the CPU firmly and close the socket lever until it snaps into its locked position.
4. Place the CPU fan and heatsink on the CPU. The heatsink should entirely cover the CPU. Carefully attach the heatsink locking brace to the plastic clips on the socket base. With the added weight of the CPU fan and heatsink locking brace, no extra force is required to keep the CPU in place.

CAUTION! Take care not to scrape the motherboard surface when mounting a clamp-style processor fan, or else damage may occur. When mounting a heatsink onto your CPU, make sure that exposed CPU capacitors do not touch the heatsink, or else damage may occur! Refer to heatsink/CPU documentation.

NOTE! Do not forget to set the correct Bus Frequency and Multiple (available only on unlocked processors) to avoid start-up problems.

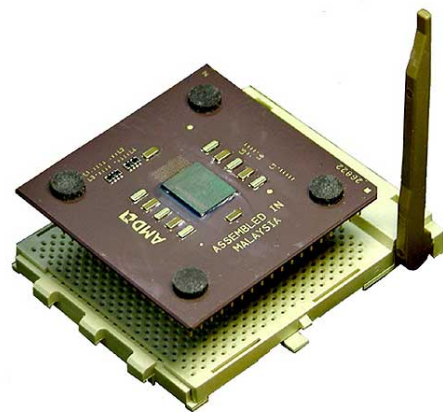

3. HARDWARE SETUP

3.7 Expansion Cards

In the future, you may need to install expansion cards. The motherboard has five PCI expansion slots to support these cards. Follow the steps in the next section when installing expansion cards.

WARNING! Unplug the system power cord when adding or removing expansion cards or other system components. Failure to do so may cause severe damage to both the motherboard and expansion cards.

3.7.1 Installing an Expansion Card

1. Read the documentation that comes with the expansion card and make any necessary hardware settings for the card before installing it.
2. Remove the system unit cover and the bracket plate on the slot you intend to use. Keep the screw for later use.
3. Align the card connectors with the slot and press firmly until the card fits in place.
4. Secure the card to the slot with the screw you removed earlier.
5. Replace the system cover.
6. Change the necessary BIOS settings, if any.
(see section **4.4.3 PCI Configuration** to change the settings.)
7. Install the necessary software drivers for the expansion card.

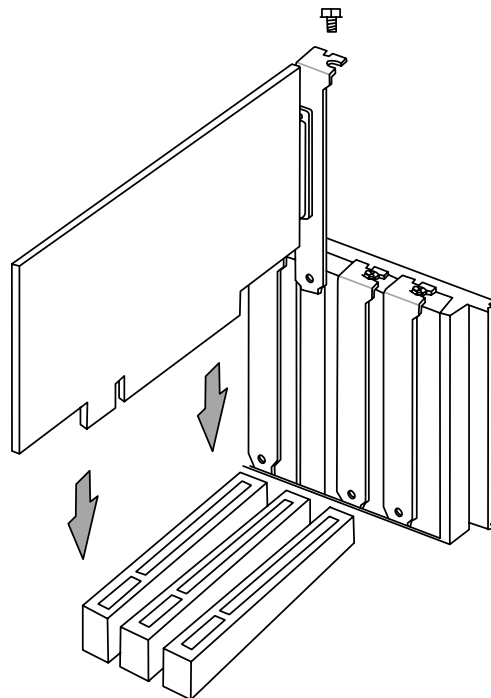

3. HARDWARE SETUP

3.7.2 Assigning IRQs for Expansion Cards

Some expansion cards need an IRQ to operate. Generally, an IRQ must be exclusively assigned to one use. In a standard design, there are 16 IRQs available but most of them are already in use, leaving 6 IRQs free for expansion cards. If your motherboard has **PCI** audio onboard, an additional IRQ will be used. If your motherboard also has **MIDI** enabled, another IRQ will be used, leaving 4 IRQs free.

IMPORTANT: If using PCI cards on shared slots, make sure that the drivers support “Share IRQ” or that the cards do not need IRQ assignments. Conflicts arise between the two PCI groups that will make the system unstable or cards inoperable.

The following table lists the default IRQ assignments for standard PC devices. Use this table when configuring your system and for resolving IRQ conflicts.

Standard Interrupt Assignments

IRQ	Priority	Standard Function
0	1	System Timer
1	2	Keyboard Controller
2	N/A	Programmable Interrupt
3*	11	Communications Port (COM2)
4*	12	Communications Port (COM1)
5*	13	Sound Card (sometimes LPT2)
6	14	Floppy Disk Controller
7*	15	Printer Port (LPT1)
8	3	System CMOS/Real Time Clock
9*	4	ACPI Mode when used
10*	5	IRQ Holder for PCI Steering
11*	6	IRQ Holder for PCI Steering
12*	7	PS/2 Compatible Mouse Port
13	8	Numeric Data Processor
14*	9	Primary IDE Channel
15*	10	Secondary IDE Channel

*These IRQs are usually available for ISA or PCI devices.

Interrupt Request Table for this Motherboard

	INT-A	INT-B	INT-C	INT-D
PCI slot 1	—	—	—	shared
PCI slot 2	shared	—	—	—
PCI slot 3	—	shared	—	—
PCI slot 4	—	—	used	—
PCI slot 5	—	—	—	shared
AGPPro slot	shared	shared	—	—
ACR slot	shared	—	—	—
Onboard audio controller	—	shared	—	—
Onboard USB controller	—	—	—	shared
Onboard IDE controller	—	—	—	shared

3. HARDWARE SETUP

3.7.3 Accelerated Graphics Port (AGP) Pro Slot

This motherboard has an Accelerated Graphics Port (AGP) Pro slot to support the new generation graphics cards with ultra-high memory bandwidth.

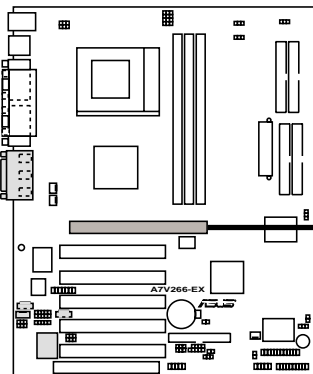

A7V266-EX Accelerated Graphics Port (AGP PRO)

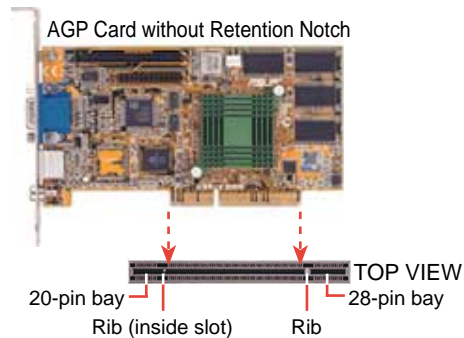

CAUTION! The AGP Pro slot is shipped with a warning label over the 20-pin bay. DO NOT remove this label and the safety tab underneath it if you are using an AGP card *without* a retention notch. Removing may cause the card to shift and may cause damage to the card, slot, and motherboard. Remove the label and tab **ONLY** if you are using an *AGP Pro* card. Use a rigid tip, such as a pen tip, to dislodge

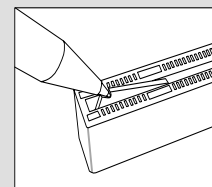

Removing the tab

3.7.4 Advanced Communication Riser (ACR) Slot

This motherboard has an Advanced Communication Riser (ACR) slot for communications and audio subsystems. The slot supports modem, audio, LAN, and Home Phoneline Networking Alliance (HPNA) or Home Networking cards. The ACR slot is backward compatible with the Audio Modem Riser (AMR) cards.

IMPORTANT! The ACR slot on the motherboard shares the same expansion slot with PCI Slot 5.

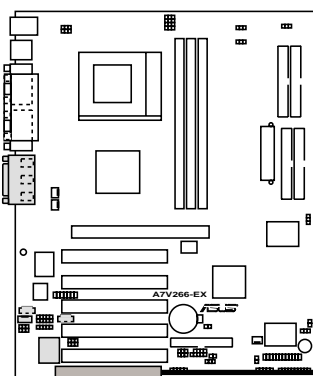

A7V266-EX Advanced Communication Riser (ACR)



3. HARDWARE SETUP

3.8 Connectors

3.8.1 External Connectors

WARNING! Some pins are used for connectors or power sources. These are clearly distinguished from jumpers in the Motherboard Layout. Placing jumper caps over these connector pins will cause damage to your motherboard.

IMPORTANT: Ribbon cables should always be connected with the red stripe to Pin 1 on the connectors. Pin 1 is usually on the side closest to the power connector on hard drives and CD-ROM drives, but may be on the opposite side on floppy disk drives. Check the connectors before installation because there may be exceptions. IDE ribbon cable must be less than 46 cm (18 in.), with the second drive connector no more than 15 cm (6 in.) from the first connector.

1) PS/2 Mouse Port (Green 6-pin PS2KBMS)

The system automatically directs IRQ12 to the PS/2 mouse if one is detected. If no mouse is detected, IRQ12 become available to expansion cards. See **PS/2 Mouse Function Control** in *4.4 Advanced Menu*.

PS/2 Mouse (6-pin Female)

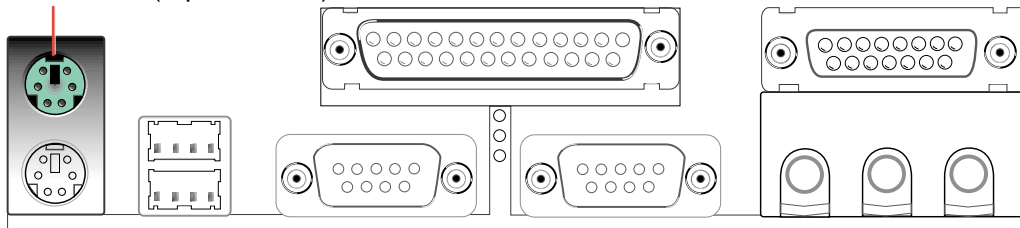

2) PS/2 Keyboard Port (Purple 6-pin PS2KBMS)

This connection is for a standard keyboard using an PS/2 plug (mini DIN). **This connector does not allow standard AT size (large DIN) keyboard plugs. You may use a DIN to mini DIN adapter on standard AT keyboards.**

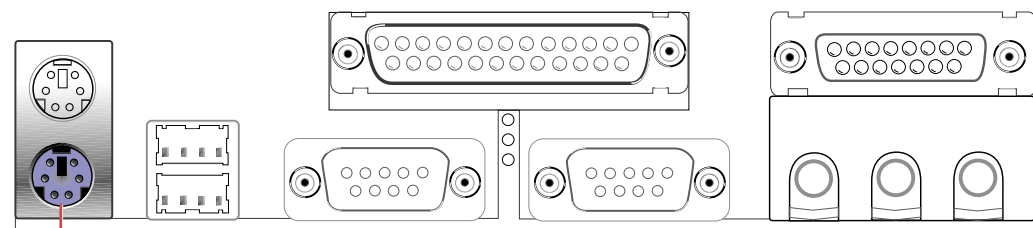

PS/2 Keyboard (6-pin Female)

3. HARDWARE SETUP

3) Universal Serial Bus Ports 1 & 2 (Black two 4-pin USB)

Two USB ports are available for connecting USB devices.

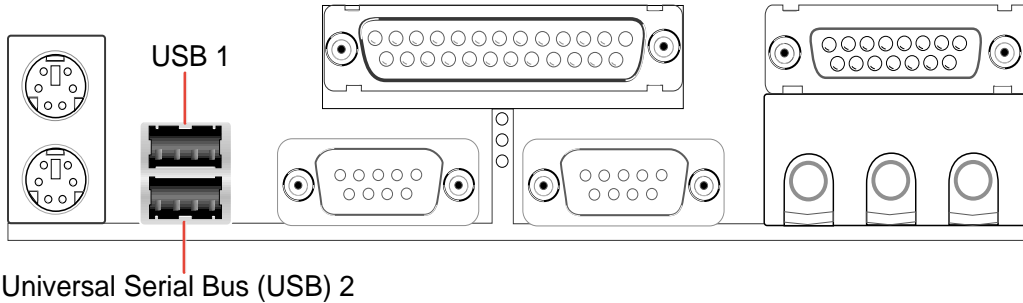

4) Parallel Port (Burgundy 25-pin PRINTER)

You can enable the parallel port and choose the IRQ through **Onboard Parallel Port** (see **4.4.2 I/O Device Configuration**).

NOTE: Serial printers must be connected to the serial port.

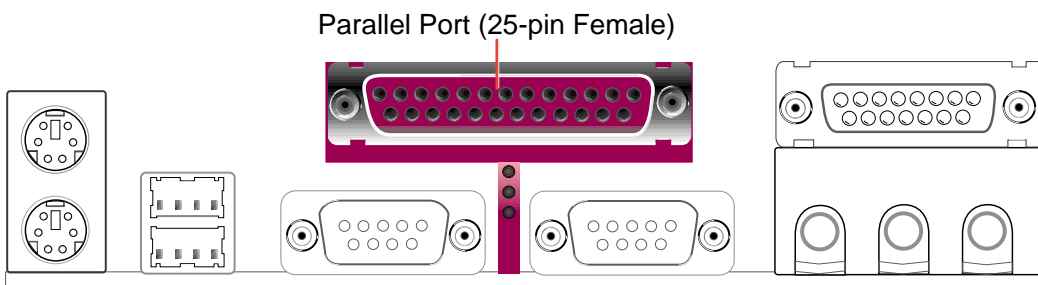

5) Serial Ports (Teal/Turquoise 9-pin COM1 / 9-pin COM2)

Two serial ports can be used for pointing devices or other serial devices. To enable these ports, see **Onboard Serial Port 1 / Onboard Serial Port 2** in **4.4.2 I/O Device Configuration** for the settings.

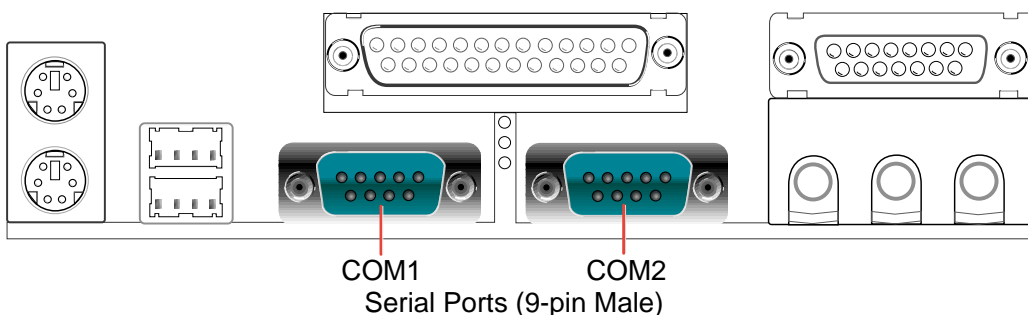

3. HARDWARE SETUP

6) Game/MIDI Ports (Gold 15-pin GAME_AUDIO) (optional)

This connector supports a joystick or a game pad for playing games, and MIDI devices for playing or editing audio files.

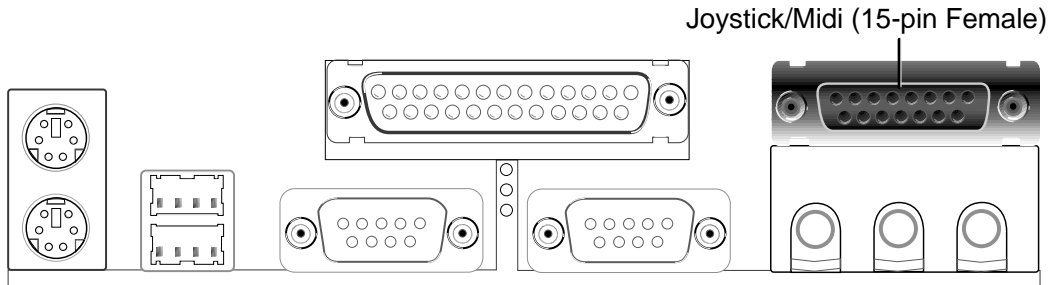

7) Audio Connectors (Three 1/8" AUDIO) (optional)

The **Line Out** (lime) connects a headphone or speakers. The **Line In** (light blue) connects a tape players or other audio sources. The **Mic** (pink) connects a microphone.

NOTE: The functions of the audio connectors Line Out, Line In, and Mic change when the 6-channel audio feature is enabled. Refer to **Chapter 5. SOFTWARE SETUP.**

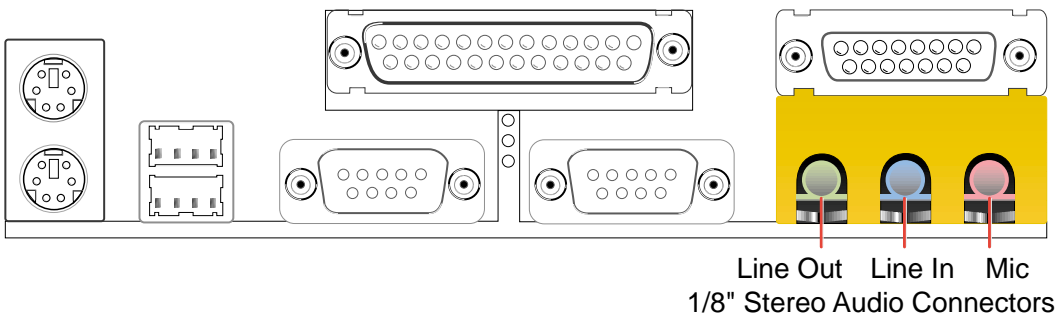

3. HARDWARE SETUP

8) IDE Activity LED (2-pin IDELED)

This connector supplies power to the cabinet's IDE activity LED. Read and write activity by devices connected to the Primary or Secondary IDE connectors cause the IDE LED to light up.

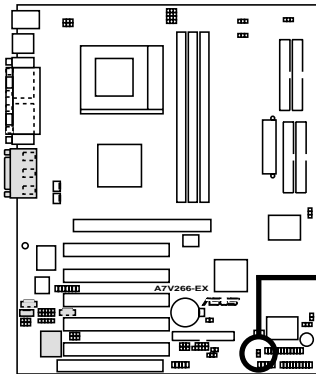

IDELED



TIP: If the case-mounted LED does not light, try reversing the 2-pin plug.

A7V266-EX IDE Activity LED

9) Floppy Disk Drive Connector (34-1 pin FLOPPY)

This connector supports the provided floppy drive ribbon cable. After connecting the single end to the board, connect the two plugs on the other end to the floppy drives. **(Pin 5 is removed to prevent inserting in the wrong orientation when using ribbon cables with pin 5 plugged).**

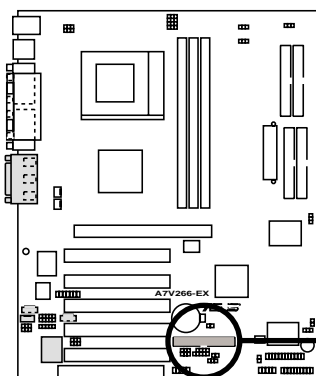

NOTE: Orient the red markings on the floppy ribbon cable to PIN 1

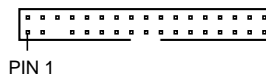

A7V266-EX Floppy Disk Drive Connector

3. HARDWARE SETUP

10) Primary (Blue) / Secondary (Black) IDE Connectors

(40-pin PRIMARY IDE and SECONDARY IDE)

(40-pin PROMISE IDE1 and PROMISE2 IDE)

These connectors support the IDE hard disk ribbon cables supplied with the motherboard. Connect the cable's blue connector to the motherboard's primary IDE connector (recommended) or the secondary IDE connector. Then connect the opposite end of the cable to your UltraDMA133//100/66 device (hard disk drive). A second slave hard disk may be attached to the intermediate connector on the cable. If a second hard disk drive is connected, you may reset its jumper to Slave mode. Refer to your hard disk documentation for the jumper settings. It is recommended that non-UltraDMA133/100/66 devices be connected to the secondary IDE connector. BIOS now supports specific device bootup (see 4.6 *Boot Menu*.) If you have more than two UltraDMA133/100/66 devices, you will need to purchase another UltraDMA100/66 cable. **(Pin 20 is removed to prevent inserting in the wrong orientation when using ribbon cables.)**

The A7V266-EX motherboard is supplied with two extra onboard IDE connectors: one Promise IDE1 and one Promise IDE2. You can use them to setup the RAID 0 or 1 arrays and to support extra IDE devices. A total of eight hard-disks, two on each IDE connector, can be connected to the A7V266-EX, but only two can function in a RAID array. See 5.4 *Software Setup* for more information about setting up a RAID array.

TIP: For high-performance and RAID 0 or 1 set ups, always setup two hard disks with *two separate* ribbon cables, one for the primary IDE connector and another for the secondary IDE connector. Usually, both disks may be set to the Master settings. Also, you may install one operating system on an IDE drive and another on a SCSI drive and select the boot disk through BIOS. (See 4.6 *Boot Menu*.)

NOTE: Do not connect any other types of IDE devices to the Promise IDE connectors; they support hard disk drive devices only.

NOTE: UltraDMA/133 is backward compatible with DMA100/66/33 and with all with existing DMA devices and systems, so there is no need to upgrade current EIDE/IDE drives and host systems.

IMPORTANT: UltraDMA66 and UltraDMA100 IDE devices require a 40-pin 80-conductor cable and RAID arrays *only operate* with such cables.

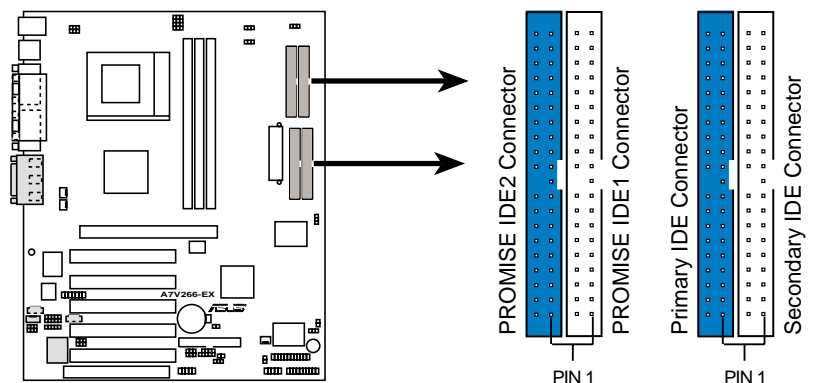

A7V266-EX IDE Connectors

NOTE: Orient the red markings (usually zigzag) on the IDE ribbon cable to PIN 1.

3. HARDWARE SETUP

11) CPU Fan, Power Fan, and Chassis Fan Connectors

(CPU_FAN, PWR_FAN, CHA_FAN)

The three fan connectors support cooling fans of 350mA (4.2 Watts) or less. Orient the fans so that the heat sink fins allow airflow to go across the onboard heat sinks instead of the expansion slots. The fan wiring and plug may vary depending on the fan manufacturer. Connect the fan cable to the connector making sure that the black wire matches the ground pin. (**NOTE:** Use the “Rotation” signal only with a specially designed fan with a rotation signal. You can monitor the Rotations Per Minute (RPM) using ASUS PC Probe (see **6. SOFTWARE REFERENCE**).

WARNING! Make sure to connect the fan cables to the fan connectors. Lack of sufficient airflow within the system could cause damage to the motherboard. **These are not jumpers, do not place jumper caps over these connectors!**

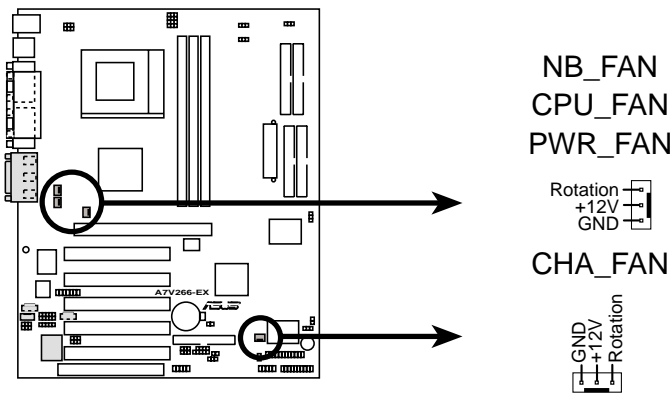

A7V266-EX 12-Volt Cooling Fan Power

12) USB Headers (10-1 pin USB2_3)

If the USB port connectors on the back panel are inadequate, two USB headers are available for two additional USB port connectors. Connect a 2-port USB connector set to a USB header and mount the USB bracket to an open slot in the chassis. (The USB connector set is optional and does not come with the motherboard package.)

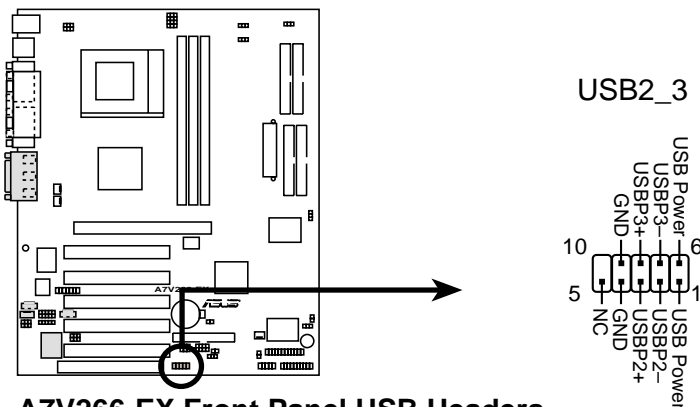

A7V266-EX Front Panel USB Headers



3. HARDWARE SETUP

13) Infrared Module Connector (10-1 pin IR_CON)

This connector supports an optional wireless transmitting and receiving infrared module. This module mounts to a small opening on system cases that support this feature. You must also configure the setting through **UART2 Use Infrared** (see **4.4.2 I/O Device Configuration**) to select whether UART2 is directed for use with COM2 or IrDA. Use the five pins as shown in Back View and connect a ribbon cable from the module to the motherboard SIR connector according to the pin definitions. (NOTE: The SIR module is not supplied with the motherboard. The CIR module is currently not available.)

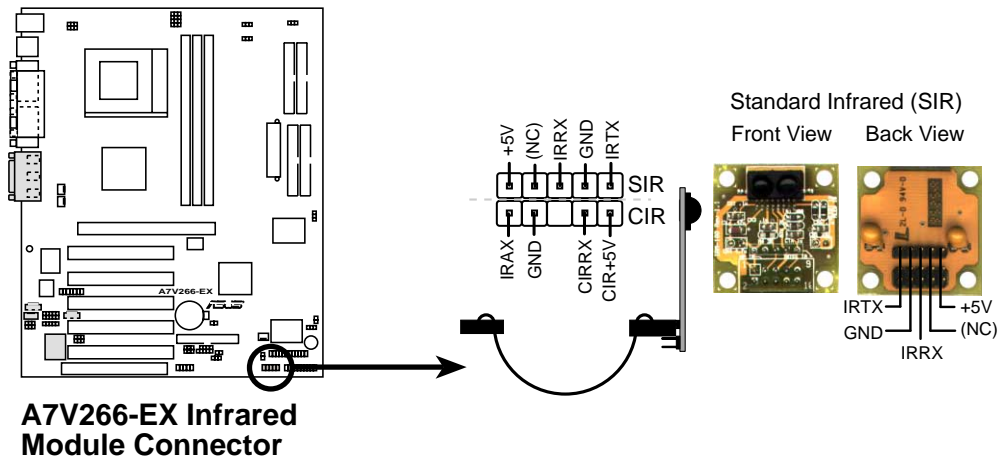

14) ASUS iPanel Connector (24-1 pin AFPANEL)

This connector supports an optional ASUS iPanel, an easy to access drive bay with front I/O ports, status LEDs, and space reserved for a hard disk drive. Alternatively, if not using an ASUS iPanel, connect an optional wireless transmitting and receiving infrared module to the SIR connector, or an optional consumer infrared connector set for wireless transmitting/remote control functions through one external infrared module.

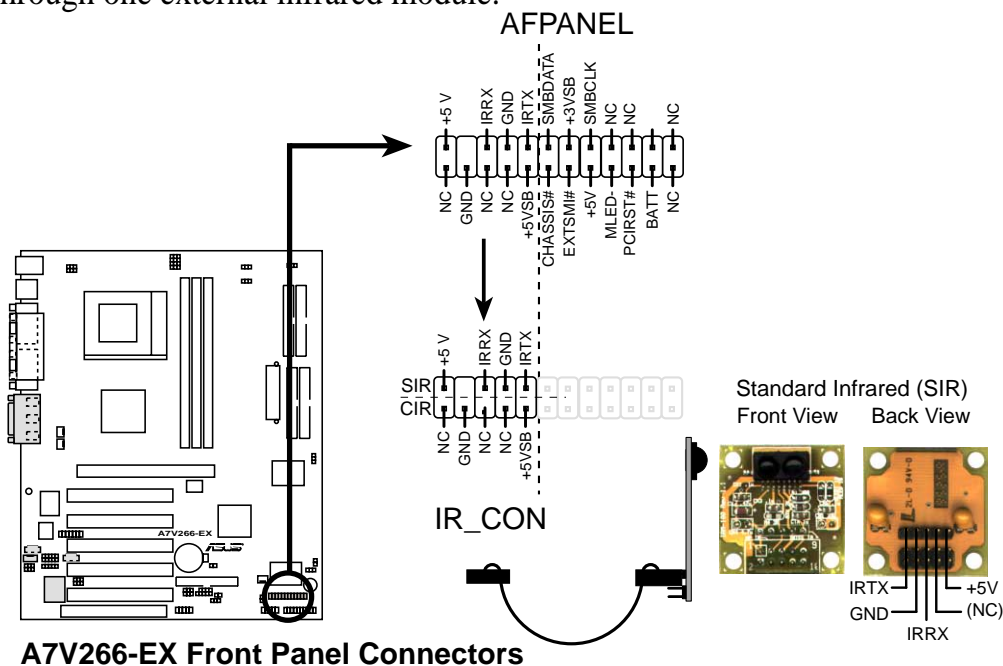

3. HARDWARE SETUP

15) Power Supply Connectors (20-pin block ATXPWR)

This connector connects to an ATX 12V power supply. The plug from the power supply fits in only one orientation because of the different hole sizes. Find the proper orientation and push down firmly making sure that the pins are aligned.

IMPORTANT: Make sure that the ATX 12V power supply (minimum recommended wattage: 230W) can supply at least 10mA on the +5-volt standby lead (+5VSB). The system may become unstable and may experience difficulty powering up if the power supply is inadequate. For Wake-On-LAN support, the ATX power supply must supply at least 720mA +5VSB.

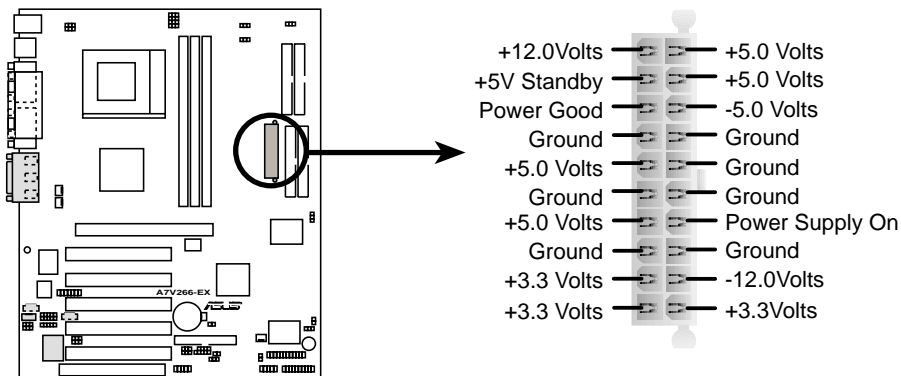

A7V266-EX ATX Power Connector

16) SMBus Connector (5-1 pin SMB)

This connector allows you to connect SMBus (System Management Bus) devices. SMBus devices communicate by means of the SMBus with an SMBus host and/or other SMBus devices. SMBus is a specific implementation of an I²C bus, a multi-device bus that allows multiple chips to connect to the same bus and enabling each one to act as a master by initiating data transfer.

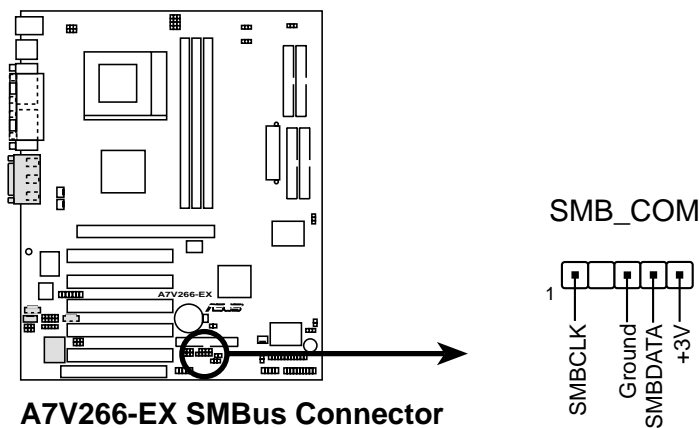

A7V266-EX SMBus Connector

3. HARDWARE SETUP

17) Internal Audio Connectors (4-1 pin CD, AUX, MODEM) (optional)

These connectors allow you to receive stereo audio input from sound sources as a CD-ROM, TV tuner, or MPEG card. The MODEM connector allows the onboard audio to interface with a voice modem card with a similar connector. It also allows the sharing of mono_in (such as a phone) and a mono_out (such as a speaker) between the audio and a voice modem card.

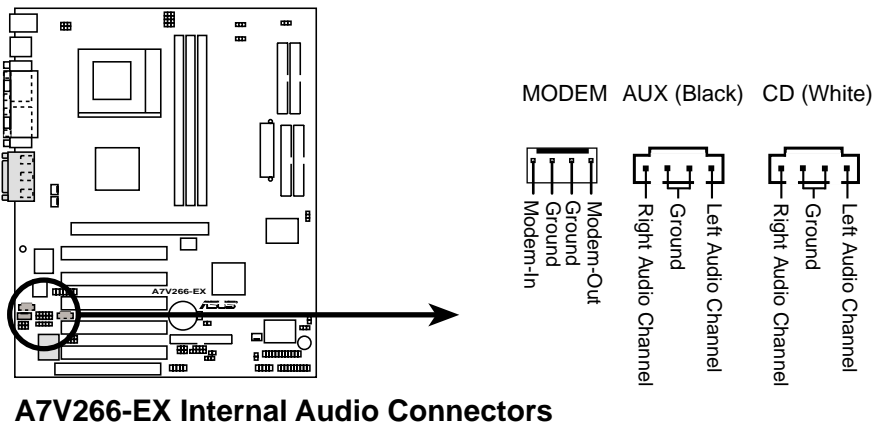

18) Power Supply Thermal Sensor Connector (2-pin JTPWR)

If you have a power supply with thermal monitoring, connect its thermal sensor cable to this connector.

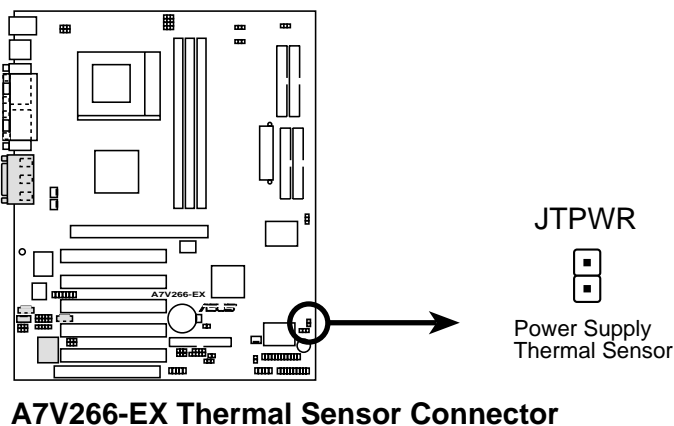

3. HARDWARE SETUP

19) Digital Audio Interfaces (2-pin SPDIFOUT/CDSPDIFIN) (optional)

These connectors connect SPDIF audio cable that allows digital instead of analog sound output from CD-ROM, DVD-ROM, CD-RW, and advanced sound cards such as SoundBlaster. Live.

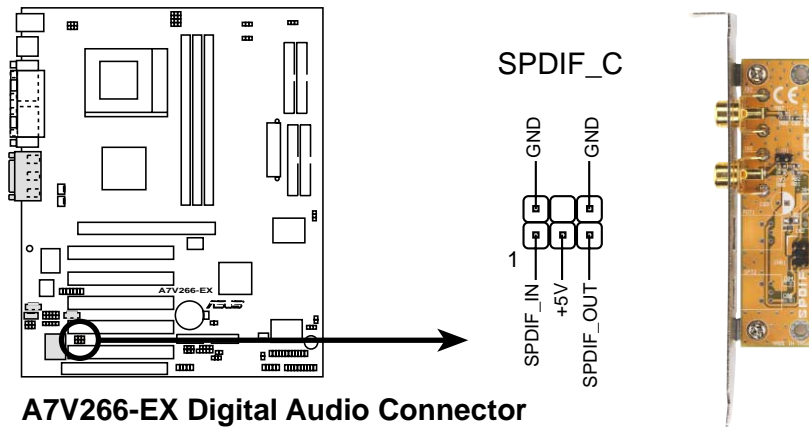

A7V266-EX Digital Audio Connector

20) Chassis Open Alarm Lead (4-pin CHASSIS)

This lead is for a chassis designed for chassis intrusion detection. This requires an external detection mechanism such as a chassis intrusion monitor/sensor or microswitch. When any chassis component is removed, the sensor is triggered and a high-level signal is sent to this lead to record a chassis intrusion event. The event is then be processed by software such as LDCM. When not using the chassis intrusion lead, place a jumper cap over the pins to close the circuit.

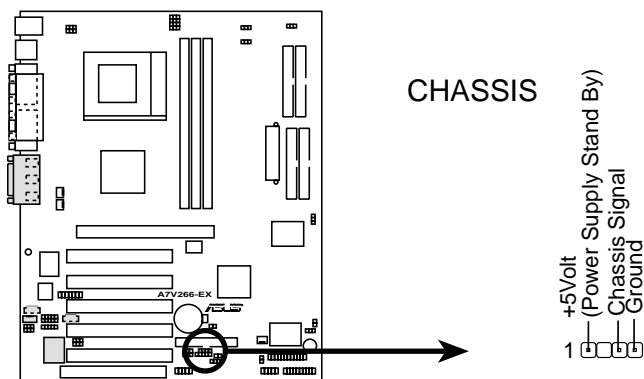

A7V266-EX Chassis Open Alarm Lead

3. HARDWARE SETUP

21) ASUS iPanel Audio Connector (10-1 pin IPANEL)

Connect the audio cable from the optional ASUS iPanel to this for front panel audio control.

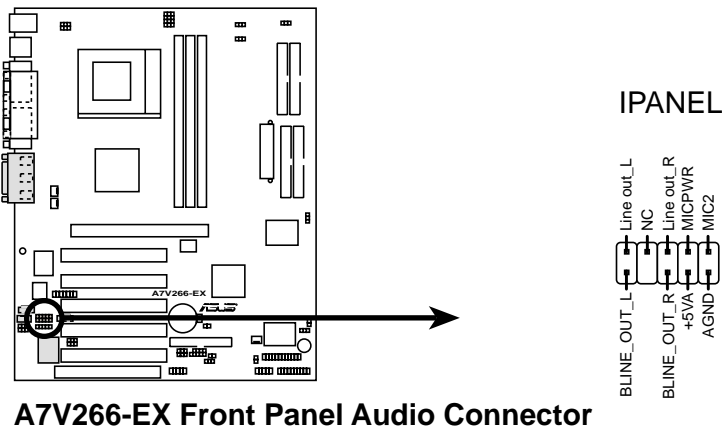

A7V266-EX Front Panel Audio Connector

22) ASUS SmartCard Connector (14-1 pin SMARTCON)

This connector attaches to an optional SmartCard reader device. The SmartCard reader permits data access from the memory chip of PC/SC smart cards.

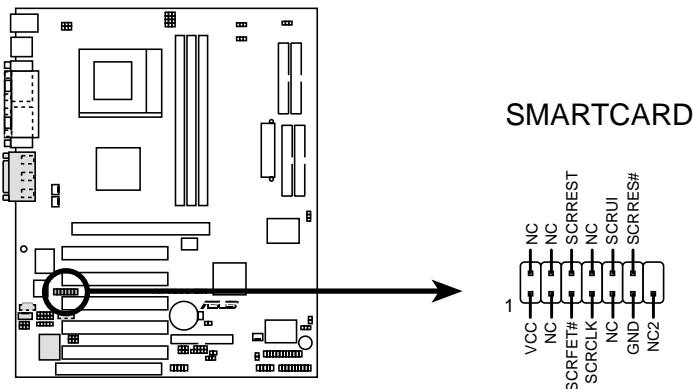

A7V266-EX Smartcard

23) ASUS Internal Line Out Connector (14-1 pin BACK_LT/BACK_RT)

This connector supplies extra audio line-out.

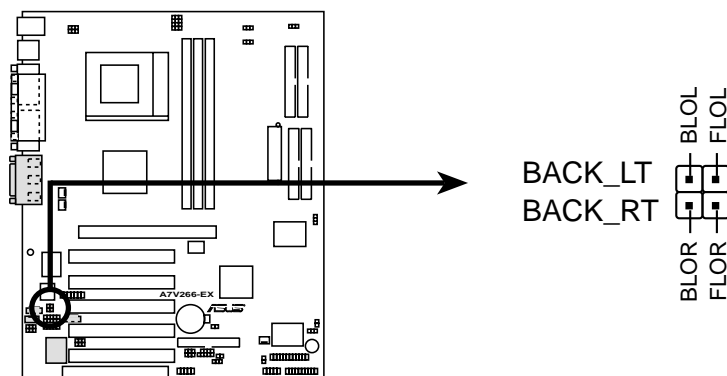

A7V266-EX Internal Line Out Connectors

3. HARDWARE SETUP

The following 20-pin PANEL illustration is for items 24-30:

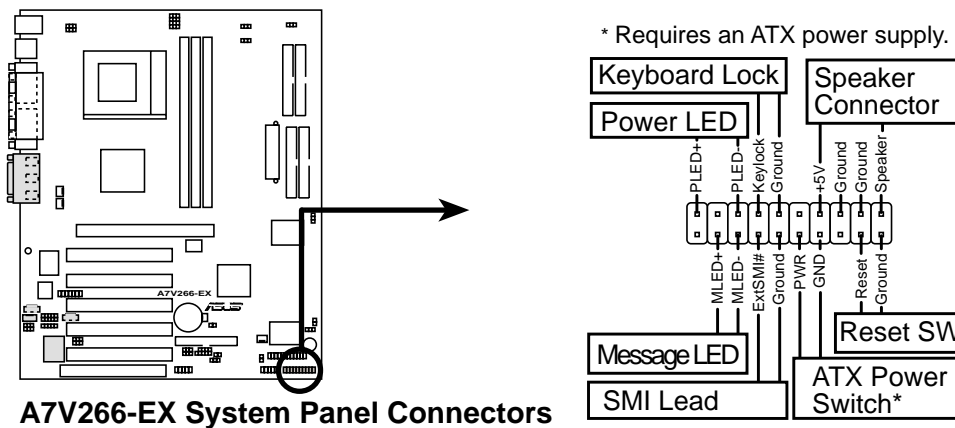

24) System Power LED Lead (3-1 pin PWR.LED)

This 3-1 pin connector connects to the system power LED. The LED lights up when you turn on the system power, and blinks when the system is in sleep or soft-off mode.

25) Keyboard Lock Switch Lead (2-pin KEYLOCK)

This 2-pin connector connects to the case-mounted key switch to allow keyboard locking.

26) System Warning Speaker Lead (4-pin SPEAKER)

This 4-pin connector connects to the case-mounted speaker and allows you to hear system beeps and warnings.

27) System Message LED Lead (2-pin MSG.LED)

This 2-pin connector is for the system message LED that indicates receipt of messages from a fax/modem. The normal status for this LED is ON, when there is no incoming data signal. The LED blinks when data is received. The system message LED feature requires an ACPI OS and driver support.

28) System Management Interrupt Lead (2-pin SMI)

This 2-pin connector allows you to manually place the system into a suspend mode, or “Green” mode, where system activity is instantly decreased to save power and to expand the life of certain system components. Attach the case-mounted suspend switch this 2-pin connector.

29) ATX Power Switch / Soft-Off Switch Lead (2-pin PWR.SW)

The system power is controlled by a momentary switch attached to this connector. Pressing the button switches the system between ON and SLEEP, or ON and SOFT OFF, depending on the BIOS or OS settings. Pressing the button while in the ON mode for more than 4 seconds turns the system off.

30) Reset Switch Lead (2-pin RESET)

This 2-pin connector connects to the case-mounted reset switch for rebooting the system without turning off the power switch. This is a preferred method.

4. BIOS SETUP

4.1 Managing and Updating Your BIOS

4.1.1 Upon First Use of the Computer System

It is recommended that you save a copy of the original motherboard BIOS along with a Flash Memory Writer utility (AFLASH.EXE) to a bootable floppy disk in case you need to reinstall the BIOS later. **AFLASH.EXE** is a Flash Memory Writer utility that updates the BIOS by uploading a new BIOS file to the programmable flash ROM on the motherboard. This file works only in DOS mode. To determine the BIOS version of your motherboard, check the last four numbers of the code displayed on the upper left-hand corner of your screen during bootup. Larger numbers represent a newer BIOS file.

1. Type **FORMAT A:/S** at the DOS prompt to create a bootable system disk. **DO NOT** copy AUTOEXEC.BAT and CONFIG.SYS to the disk.
2. Type **COPY D:\AFLASH\AFLASH.EXE A:** (assuming D is your CD-ROM drive) to copy AFLASH.EXE to the boot disk you created.
NOTE: AFLASH works only in DOS mode. It does not work in the DOS prompt within Windows and does not work with certain memory drivers that may be loaded when you boot from the hard drive. It is recommended that you reboot using a floppy disk.
3. Reboot the computer from the floppy disk.

NOTE: BIOS setup must specify “Floppy” as the first item in the boot sequence.

4. In DOS mode, type **A:\AFLASH <Enter>** to run AFLASH.

```
ASUS ACPI BIOS
FLASH MEMORY WRITER V1.29
Copyright (C) 1994-99, ASUSTeK COMPUTER INC.

Flash Memory: Winbond W29C020 or SST 29EE020 or Intel B2802AB

Current BIOS Version: ASUS XXX-XX ACPI BIOS Revision 100X
BIOS Model          : XXX-XX
BIOS Built Date     : 09/25/98

Choose one of the followings:

1. Save Current BIOS To File
2. Update BIOS Including Boot Block and ESCD

Enter choice: [1]

Press ESC To Exit
```

IMPORTANT! If the word “unknown” appears after **Flash Memory:**, the memory chip is either not programmable or is not supported by the ACPI BIOS and therefore, cannot be programmed by the Flash Memory Writer utility.

4. BIOS SETUP

5. Select **1. Save Current BIOS to File** from the Main menu and press <Enter>. The **Save Current BIOS To File** screen appears.

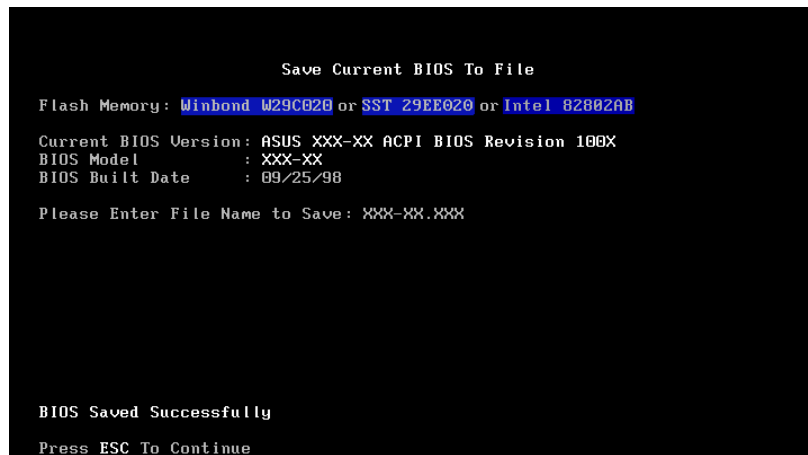

```
Save Current BIOS To File
Flash Memory: Winbond W29C020 or SST 29EE020 or Intel 82802AB
Current BIOS Version: ASUS XXX-XX ACPI BIOS Revision 100X
BIOS Model          : XXX-XX
BIOS Built Date     : 09/25/98
Please Enter File Name to Save: XXX-XX.XXX

BIOS Saved Successfully
Press ESC To Continue
```

6. Type a filename and the path, for example, **A:\XXX-XX.XXX** and then press <Enter>.

4. BIOS SETUP

4.1.2 Updating BIOS Procedures

WARNING! Update the BIOS only if you have problems with the motherboard and you know that the new BIOS revision will solve your problems. Careless updating can result in your motherboard having more problems!

1. Download an updated ASUS BIOS file from the Internet (WWW or FTP) (see ASUS CONTACT INFORMATION on page 3 for details) and save to the boot floppy disk you created earlier.
2. Boot from the floppy disk.
3. At the “A:\” prompt, type **AFLASH** and then press <Enter>.
4. At the **Main Menu**, type **2** then press <Enter>. The **Update BIOS Including Boot Block and ESCD** screen appears.
5. Type the filename of your new BIOS and the path, for example, **A:\XXX-XX.XXX**, then press <Enter>.

NOTE: To cancel this operation, press <Enter>.

```
Update BIOS Including Boot Block and ESCD
Flash Memory: Winbond W29C020 or SST 29EE020 or Intel 82802AB
Current BIOS Version: ASUS XXX-XX ACPI BIOS Revision 100X
BIOS Model          : XXX-XX
BIOS Built Date     : 09/25/98
Please Enter File Name for NEW BIOS: A:\XXX-XX.XXX
```

6. When prompted to confirm the BIOS update, press **Y** to start the update.

```
Update BIOS Including Boot Block and ESCD
Flash Memory: Winbond W29C020 or SST 29EE020 or Intel 82802AB
BIOS Version
[CURRENT] ASUS XXX-XX ACPI BIOS Revision 100X
[test.awd] ASUS XXX-XX ACPI BIOS Revision 100X
BIOS Model
[CURRENT] XXX-XX
[test.awd] XXX-XX
Date of BIOS Built
[CURRENT] 09/25/99
[XXXX.XXX] 05/29/00
Check sum of 1001.010 is F266.
Are you sure (Y/N) ? [Y]
Press ESC To Return to Main Menu
```

4. BIOS SETUP
Updating BIOS

4. BIOS SETUP

- The utility starts to program the new BIOS information into the Flash ROM. The boot block is updated automatically only when necessary. This minimizes the possibilities of boot problems in case of update failures. When the programming is done, *Flashed Successfully* appears.

```
Update BIOS Including Boot Block and ESCD
Flash Memory: Winbond W29C020 or SST 29EE020 or Intel B2802AB
BIOS Version
[CURRENT] ASUS XXX-XX ACPI BIOS Revision 100X
[test.awd] ASUS XXX-XX ACPI BIOS Revision 100X
BIOS Model
[CURRENT] XXX-XX
[test.awd] XXX-XX
Date of BIOS Built
[CURRENT] 09/25/99
[XXXX.XXX] 05/29/00
Check sum of 1001.010 is F266.
Are you sure (Y/N) ? [Y]
Block Erasing -- Done
Programming -- 3FFFF
Flashed Successfully
Press ESC To Continue
```

- Follow the onscreen instructions to continue.

```
ASUS ACPI BIOS
FLASH MEMORY WRITER V1.29
Copyright (C) 1994-99, ASUSTeK COMPUTER INC.
Flash Memory: Winbond W29C020 or SST 29EE020 or Intel B2802AB
Current BIOS Version: ASUS XXX-XX ACPI BIOS Revision 100X
BIOS Model : XXX-XX
BIOS Built Date : 05/29/99
Choose one of the followings:
1. Save Current BIOS To File
2. Update BIOS Including Boot Block and ESCD
Enter choice: [1]
You have flashed the EPROM;It is recommended that you turn off
the power, enter SETUP and LOAD Setup Defaults to have CMOS
updated with new BIOS when exits.
Press ESC To Exit
```

WARNING! If you encounter problems while updating the new BIOS, DO NOT turn off the system because this may cause boot problems. Just repeat the process, and if the problem still persists, load the original BIOS file you saved to the boot disk. If the Flash Memory Writer utility is not able to successfully update a complete BIOS file, the system may not boot. If this happens, call the ASUS service center for support.

4. BIOS SETUP

4.2 BIOS Setup Program

This motherboard supports a programmable EEPROM that you can update using the provided utility described in *4.1 Managing and Updating Your BIOS*.

The utility is used if you are installing a motherboard, reconfiguring your system, or prompted to “**Run Setup**”. This section describes how to configure your system using this utility.

Even if you are not prompted to use the Setup program, at some time in the future you may want to change the configuration of your computer. For example, you may want to enable the Security Password Feature or make changes to the power management settings. It will then be necessary to reconfigure your system using the BIOS Setup program so that the computer can recognize these changes and record them in the CMOS RAM of the EEPROM.

The EEPROM on the motherboard stores the Setup utility. When you start up the computer, the system provides you with the opportunity to run this program. This appears during the Power-On Self Test (POST). Press <Delete> to call up the Setup utility. If you are a little bit late in pressing the mentioned key, POST will continue with its test routines, thus preventing you from calling up Setup. If you still need to call Setup, restart the system by pressing <Ctrl> + <Alt> + <Delete>, or by pressing the Reset button on the system chassis. You can also restart by turning the system off and then back on again. But do so only if the first two methods fail.

The Setup program has been designed to make it as easy to use as possible. It is a menu-driven program, which means you can scroll through the various sub-menus and make your selections among the predetermined choices.

To access the BIOS Setup program, press the <Delete> key after the computer has run through its POST.

NOTE: Because the BIOS software is constantly being updated, the following BIOS setup screens and descriptions are for reference purposes only, and may not exactly match what you see on your screen.

4. BIOS SETUP

4.2.1 BIOS Menu Bar

The top of the screen has a menu bar with the following selections:

- MAIN** Use this menu to make changes to the basic system configuration.
- ADVANCED** Use this menu to enable and make changes to the advanced features.
- POWER** Use this menu to configure and enable Power Management features.
- BOOT** Use this menu to configure the default system device used to locate and load the Operating System.
- EXIT** Use this menu to exit the current menu or specify how to exit the Setup program.

To access the menu bar items, press the right or left arrow key on the keyboard until the desired item is highlighted.

4.2.2 Legend Bar

At the bottom of the Setup screen is a legend bar. The keys in the legend bar allow you to navigate through the various setup menus. The following table lists the keys found in the legend bar with their corresponding functions.

Navigation Key(s)	Function Description
<F1> or <Alt + H>	Displays the General Help screen from anywhere in the BIOS Setup
<Esc>	Jumps to the Exit menu or returns to the main menu from a sub-menu
← or → (keypad arrow)	Selects the menu item to the left or right
↑ or ↓ (keypad arrow)	Moves the highlight up or down between fields
- (minus key)	Scrolls backward through the values for the highlighted field
+ (plus key) or spacebar	Scrolls forward through the values for the highlighted field
<Enter>	Brings up a selection menu for the highlighted field
<Home> or <PgUp>	Moves the cursor to the first field
<End> or <PgDn>	Moves the cursor to the last field
<F5>	Resets the current screen to its Setup Defaults
<F10>	Saves changes and exits Setup

4. BIOS SETUP

General Help

In addition to the Item Specific Help window, the BIOS setup program also provides a General Help screen. You may launch this screen from any menu by simply pressing <F1> or the <Alt> + <H> combination. The General Help screen lists the legend keys with their corresponding functions.

Saving Changes and Exiting the Setup Program

See *4.7 Exit Menu* for detailed information on saving changes and exiting the setup program.

Scroll Bar

When a scroll bar appears to the right of a help window, it indicates that there is more information to be displayed that will not fit in the window. Use <PgUp> and <PgDn> or the up and down arrow keys to scroll through the entire help document. Press <Home> to display the first page, press <End> to go to the last page. To exit the help window, press <Enter> or <Esc>.

Sub-Menu

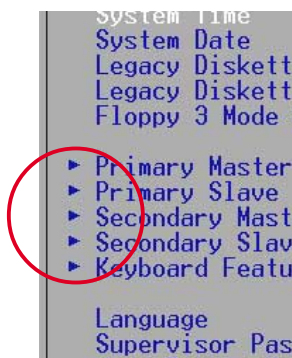

Note that a right pointer symbol (as shown in the left view) appears to the left of certain fields. This pointer indicates that you can display a sub-menu from this field. A sub-menu contains additional options for a field parameter. To display a sub-menu, move the highlight to the field and press <Enter>. The sub-menu appears. Use the legend keys to enter values and move from field to field within a sub-menu as you would within a menu. Use the <Esc> key to return to the main menu.

Take some time to familiarize yourself with the legend keys and their corresponding functions. Practice navigating through the various menus and sub-menus. If you accidentally make unwanted changes to any of the fields, use the set default hot key <F5> to load the Setup default values. While moving around through the Setup program, note that explanations appear in the Item Specific Help window located to the right of each menu. This window displays the help text for the currently highlighted field.

NOTE: The item heading in square brackets represents the default setting for that field.

4. BIOS SETUP

4.3 Main Menu

When you enter the Setup program, the following screen appears:

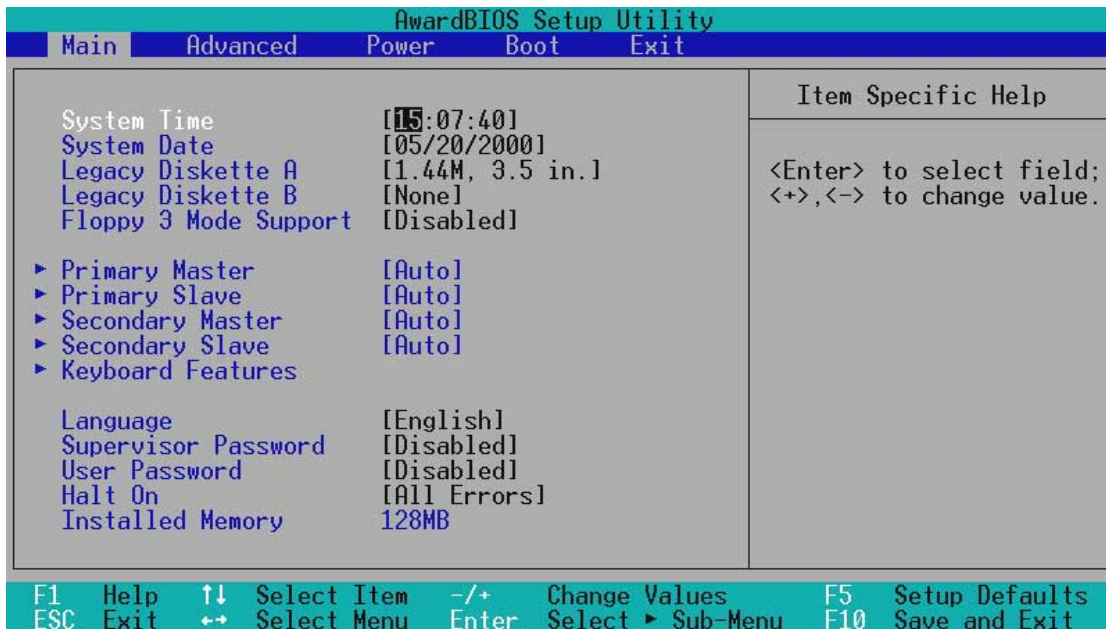

System Time [XX:XX:XX]

Sets the system to the time that you specify (usually the current time). The format is hour, minute, second. Valid values for hour, minute and second are **Hour: (00 to 23)**, **Minute: (00 to 59)**, **Second: (00 to 59)**. Use the <Tab> or <Shift> + <Tab> keys to move between the hour, minute, and second fields.

System Date [XX/XX/XXXX]

Sets the system to the date that you specify (usually the current date). The format is month, day, year. Valid values for month, day, and year are **Month: (1 to 12)**, **Day: (1 to 31)**, **Year: (100 year range)**. Use the <Tab> or <Shift> + <Tab> keys to move between the month, day, and year fields.

Legacy Diskette A [1.44M, 3.5 in.], Legacy Diskette B [None]

Sets the type of floppy drives installed. Configuration options: [None] [360K, 5.25 in.] [1.2M, 5.25 in.] [720K, 3.5 in.] [1.44M, 3.5 in.] [2.88M, 3.5 in.]

Floppy 3 Mode Support [Disabled]

This is required to support older Japanese floppy drives. The Floppy 3 Mode feature allows reading and writing of 1.2MB (as opposed to 1.44MB) on a 3.5-inch diskette. Configuration options: [Disabled] [Enabled]

4. BIOS SETUP

4.3.1 Primary & Secondary Master/Slave

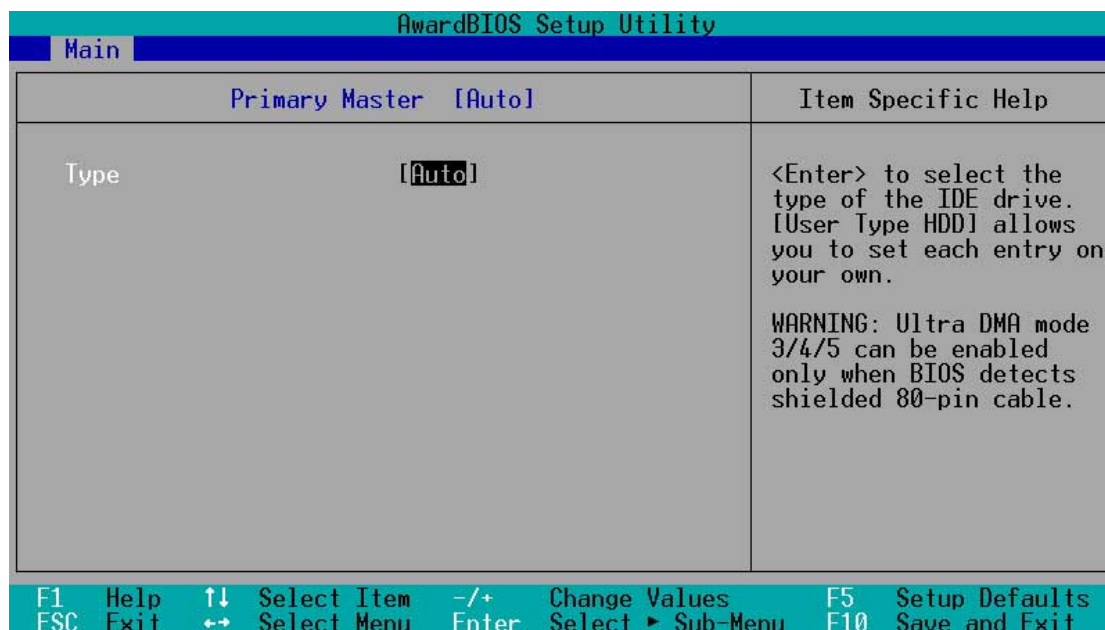

Type [Auto]

Select [Auto] to automatically detect an IDE hard disk drive. If automatic detection is successful, Setup automatically fills in the correct values for the remaining fields on this sub-menu. If automatic detection fails, this may be because the hard disk drive is too old or too new. If the hard disk was already formatted on an older system, Setup may detect incorrect parameters. In these cases, select [User Type HDD] to manually enter the IDE hard disk drive parameters. Refer to the next section for details.

NOTE: After entering the IDE hard disk drive information into BIOS, use a disk utility, such as FDISK, to partition and format new IDE hard disk drives. This is necessary so that you can write or read data from the hard disk. Make sure to set the partition of the Primary IDE hard disk drives to active.

CAUTION! Before attempting to configure a hard disk drive, make sure you have the configuration information supplied by the drive manufacturer. Incorrect settings may cause the system to fail to recognize the installed hard disk.

4. BIOS SETUP

[User Type HDD]

AwardBIOS Setup Utility			
Main			
Primary Master [User Type HDD]		Item Specific Help	
Type	[User Type HDD]	<p><Enter> to select the type of the IDE drive. [User Type HDD] allows you to set each entry on your own.</p> <p>WARNING: Ultra DMA mode 3/4/5 can be enabled only when BIOS detects shielded 80-pin cable.</p>	
Translation Method	[LBA]		
Cylinders	[1024]		
Head	[255]		
Sector	[63]		
CHS Capacity	8422MB		
Maximum LBA Capacity	25590MB		
Multi-Sector Transfers	[Maximum]		
SMART Monitoring	[Disabled]		
PIO Mode	[4]		
ULTRA DMA Mode	[Disabled]		
F1 Help ↑↓ Select Item -/+ Change Values F5 Setup Defaults ESC Exit ↔ Select Menu Enter Select ► Sub-Menu F10 Save and Exit			

Manually enter the number of cylinders, heads and sectors per track for the drive. Refer to the drive documentation or on the drive label for this information. If no drive is installed or if you are removing a drive and not replacing it, select [None].

Translation Method [LBA]

Select the hard disk drive type in this field. When Logical Block Addressing (LBA) is enabled, 28-bit addressing of the hard drive disregarding cylinders, heads, or sectors. Note that LBA Mode is necessary for drives with more than 504MB storage capacity. Configuration options: [LBA] [LARGE] [Normal] [Match Partition Table] [Manual]

Cylinders

This field configures the number of cylinders. Refer to the drive documentation to determine the correct value to enter into this field. **NOTE:** To make changes to this field, set the **Type** field to [User Type HDD] and the **Translation Method** field to [Manual].

Head

This field configures the number of read/write heads. Refer to the drive documentation to determine the correct value to enter into this field. **NOTE:** To make changes to this field, set the **Type** field to [User Type HDD] and the **Translation Method** field to [Manual].

Sector

This field configures the number of sectors per track. Refer to the drive documentation to determine the correct value to enter into this field. **NOTE:** To make changes to this field, set the **Type** field to [User Type HDD] and the **Translation Method** field to [Manual].

4. BIOS SETUP

CHS Capacity

This field shows the drive's maximum CHS capacity as calculated by the BIOS based on the drive information you entered.

Maximum LBA Capacity

This field shows the drive's maximum LBA capacity as calculated by the BIOS based on the drive information you entered.

Multi-Sector Transfers [Maximum]

This option automatically sets the number of sectors per block to the highest number that the drive supports. Note that when this field is automatically configured, the set value may not always be the fastest value for the drive. You may also manually configure this field. Refer to the documentation that came with the hard drive to determine the optimum value and set it manually. **NOTE:** To make changes to this field, set the **Type** field to [User Type HDD]. Configuration options: [Disabled] [2 Sectors] [4 Sectors] [8 Sectors] [16 Sectors] [32 Sectors] [Maximum]

SMART Monitoring [Disabled]

This field allows you to enable or disable the S.M.A.R.T. (Self-Monitoring, Analysis and Reporting Technology) system that utilizes internal hard disk drive monitoring technology. This parameter is normally disabled because the resources used in the SMART monitoring feature may decrease system performance. Configuration options: [Disabled] [Enabled]

PIO Mode [4]

This option lets you set a PIO (Programmed Input/Output) mode for the IDE device. Modes 0 through 4 provide successively increased performance. Configuration options: [0] [1] [2] [3] [4]

Ultra DMA Mode [Disabled]

Ultra DMA capability allows improved transfer speeds and data integrity for compatible IDE devices. Set to [Disabled] to suppress Ultra DMA capability.

NOTE: To make changes to this field, set the **Type** field to [User Type HDD]. Configuration options: [0] [1] [2] [3] [4] [5] [Disabled]

Other options for the **Type** field are:

[CD-ROM] - for IDE CD-ROM drives

[LS-120] - for LS-120 compatible floppy disk drives

[ZIP-100] - for ZIP-100 compatible disk drives

[MO] - for IDE magneto optical disk drives

[Other ATAPI Device] - for IDE devices not listed here

After making your selections on this sub-menu, press the <Esc> key to return to the Main menu. When the Main menu appears, the hard disk drive field displays the size for the hard disk drive that you configured.

4. BIOS SETUP

4.3.2 Keyboard Features

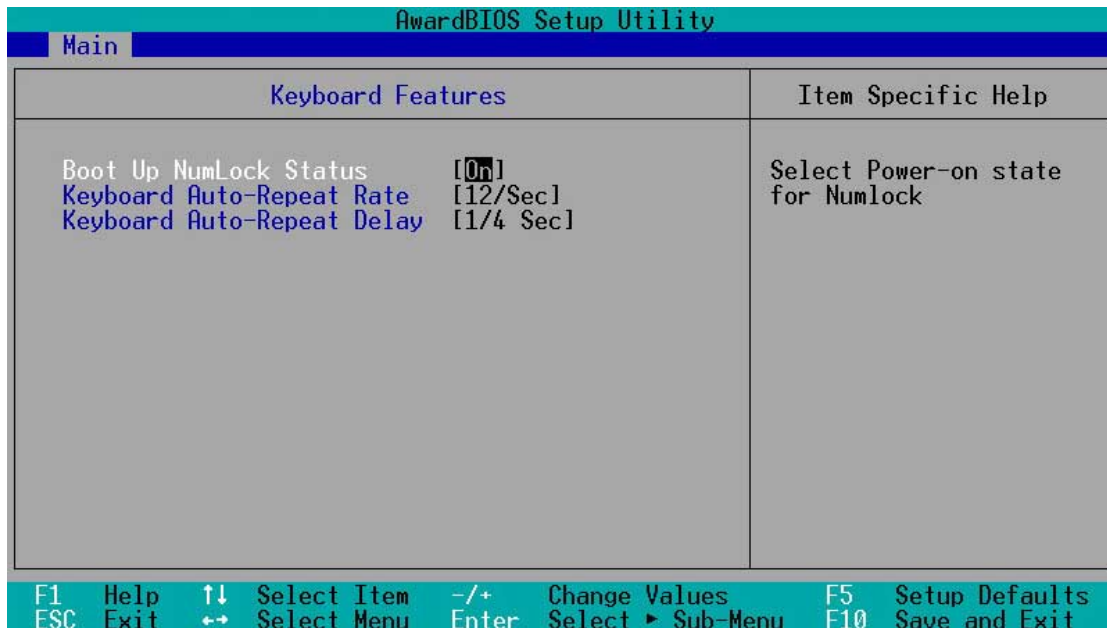

Boot Up NumLock Status [On]

This field enables users to activate the Number Lock function upon system boot. Configuration options: [Off] [On]

Keyboard Auto-Repeat Rate [12/Sec]

This controls the speed at which the system registers repeated keystrokes. Options range from 6 to 30 characters per second. Configuration options: [6/Sec] [8/Sec] [10/Sec] [12/Sec] [15/Sec] [20/Sec] [24/Sec] [30/Sec]

Keyboard Auto-Repeat Delay [1/4 Sec]

This field sets the time interval for displaying the first and second characters. Configuration options: [1/4 Sec] [1/2 Sec] [3/4 Sec] [1 Sec]

4. BIOS SETUP

Language [English]

This field displays the BIOS language version.

Supervisor Password [Disabled] / User Password [Disabled]

These fields allow you to set passwords. To set a password, highlight the appropriate field and press <Enter>. Type in a password then press <Enter>. You can type up to eight alphanumeric characters. Symbols and other characters are ignored. To confirm the password, type the password again and press <Enter>. The password is now set to [Enabled]. This password allows full access to the BIOS Setup menus. To clear the password, highlight this field and press <Enter>. The same dialog box as above appears. Press <Enter>. The password is set to [Disabled].

A Note about Passwords

The BIOS Setup program allows you to specify passwords in the Main menu. The passwords control access to the BIOS during system startup. Passwords are not case sensitive, meaning, it makes no difference whether you the password using uppercase or lowercase letters. The BIOS Setup program allows you to specify two different passwords: a Supervisor password and a User password. If you did not set a Supervisor password, anyone can access the BIOS Setup program. If you did, the Supervisor password is required to enter the BIOS Setup program and to gain full access to the configuration fields.

Forgot the Password?

If you forget your password, you can clear it by erasing the CMOS Real Time Clock (RTC) RAM. The RAM data containing the password information is powered by the onboard button cell battery.

To erase the RTC RAM:

1. Turn OFF the computer and unplug the power cord.
2. Remove the battery.
3. Short the jumper.
4. Re-install the battery.
5. Plug the power cord and turn ON the computer.
6. Hold down the key during the boot process and enter BIOS setup to re-enter data.

Halt On [All Errors]

This field specifies the types of errors that will cause the system to halt. Configuration options: [All Errors] [No Error] [All but Keyboard] [All but Disk] [All but Disk/Keyboard]

Installed Memory [XXX MB]

This field automatically displays the amount of conventional memory detected by the system during the boot process.

4. BIOS SETUP

4.4 Advanced Menu

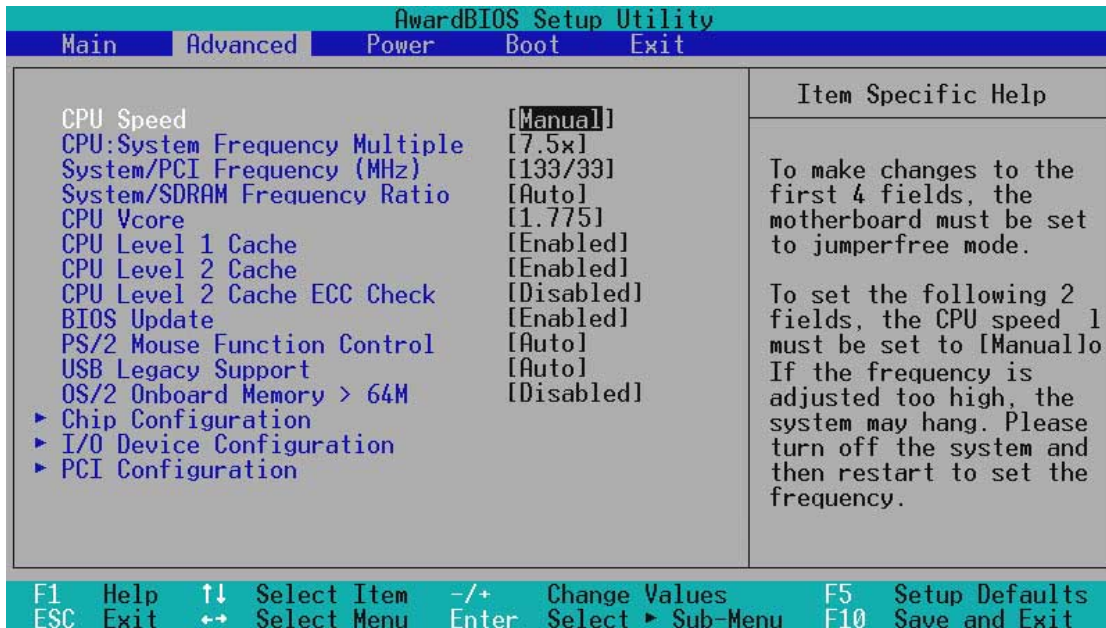

CPU Speed [Manual]

When the motherboard is set to JumperFree™ mode, this field sets the internal frequency of your CPU. Select [Manual] if you want to make changes to the next two fields. Note that selecting a frequency higher than the CPU manufacturer recommends may cause the system to hang or crash. Configuration options: [Manual] [750MHz] [1000MHz]

CPU : System Frequency Multiple, (if CPU Speed set to [Manual])

This field is for unlocked processors only and will not be available to standard AMD processors. If the processor frequency multiple is detected as being locked, you cannot access this field. For unlocked processors, this field sets the frequency multiple between the CPU's *internal* frequency (CPU speed) and the *external* frequency. Set this field in conjunction with the **System/PCI Frequency (MHz)** to match the speed of the CPU. Configuration options: [5x/14x] [5.5x] [6.0x]...[12.0x] [12.5x]

System/PCI Frequency (MHz) (if CPU Speed set to [Manual])

This feature tells the clock generator what frequency to send to the system bus and PCI bus. The bus frequency (external frequency) multiplied by the bus multiple equals the **CPU speed**. Configuration ranges from 100/33 to 227/57.

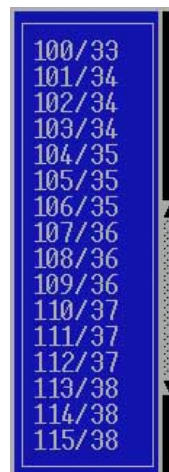

4. BIOS SETUP

System/SDRAM Frequency Ratio [Auto]

This field determines whether the memory clock frequency is set to be in synchronous or asynchronous mode with respect to the system frequency. The options that appear in the popup menu vary according to the **System/PCI Frequency (MHz)**. Configuration options: [Auto] [100:100] [100:133]

Vcore [1.775V]

This field determines the range of core voltage available to the Central Processing Unit. Configuration options: [1.850] [1.825] [1.800] [1.775] [1.750]

CPU Level 1 Cache, CPU Level 2 Cache [Enabled]

These fields allow you to choose from the default of [Enabled] or choose [Disabled] to turn on or off the CPU Level 1 and Level 2 built-in cache. Configuration options: [Disabled] [Enabled]

CPU Level 2 Cache ECC Check [Disabled]

This function controls the ECC capability in the CPU level 2 cache. Configuration options: [Disabled] [Enabled]

BIOS Update [Enabled]

This field functions as an update loader integrated into the BIOS to supply the processor with the required data. When set to [Enabled], the BIOS loads the update on all processors during system bootup. Configuration options: [Disabled] [Enabled]

PS/2 Mouse Function Control [Auto]

The default setting [Auto] allows the system to detect a PS/2 mouse at startup. If a mouse is detected, the BIOS assigns IRQ12 to the PS/2 mouse. Otherwise, IRQ12 can be used for expansion cards. When you set this field to [Enabled], BIOS always reserves IRQ12, whether or not a PS/2 mouse is detected at startup. Configuration options: [Enabled] [Auto]

USB Legacy Support [Auto]

This motherboard supports Universal Serial Bus (USB) devices. The default of [Auto] allows the system to detect a USB device at startup. If detected, the USB controller is enabled. If not detected, the USB controller is disabled. When you set this field to [Disabled], the USB controller is disabled whether you are using a USB device or not. Configuration options: [Disabled] [Enabled] [Auto]

OS/2 Onboard Memory > 64M [Disabled]

When using OS/2 operating systems with installed DRAM of greater than 64MB, you need to set this option to [Enabled]. Otherwise, leave to the default setting [Disabled]. Configuration options: [Disabled] [Enabled]

4. BIOS SETUP

Notes for JumperFree Mode

CPU Upgrade/Reinstallation

To ensure that the system can enter BIOS Setup after changing the processor, the system starts up running at a bus speed of 100MHz and a fail-safe CPU internal frequency. Then it automatically enters the Advanced menu with a popup display of all the possible CPU internal frequencies.

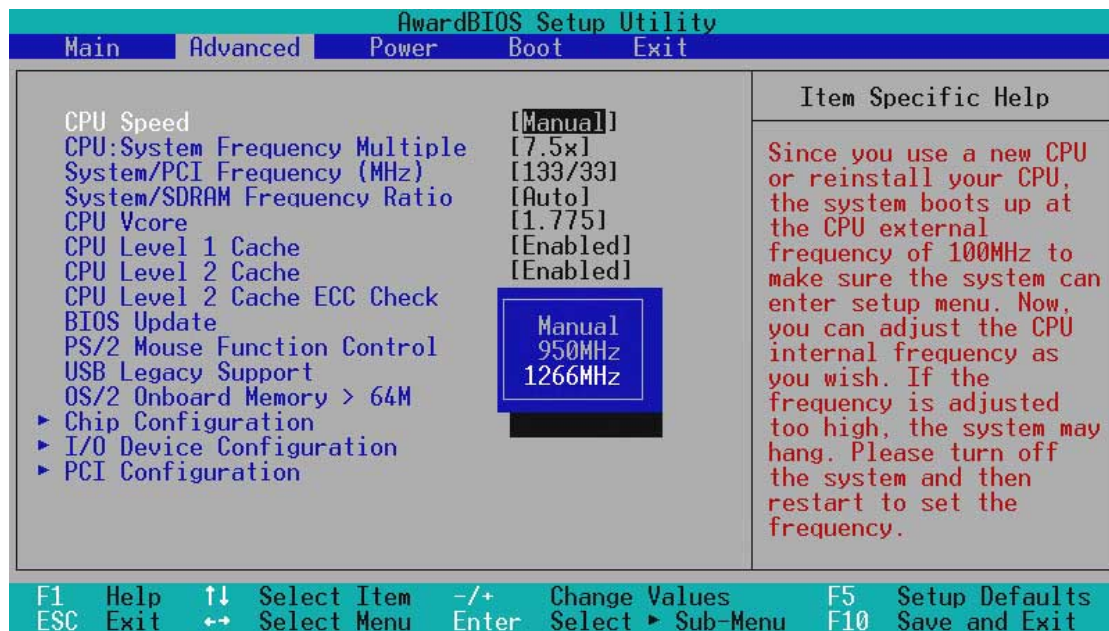

For processors with locked frequency multiplier

4. BIOS SETUP

System Hangup

If the system crashes or hangs due to improper frequency settings, power OFF the system and restart. The system starts up in safe mode running at a bus speed of 100MHz and enters the BIOS Setup.

AwardBIOS Setup Utility				
Main	Advanced	Power	Boot	Exit
CPU Speed	[750MHz]	Item Specific Help		
CPU: System Frequency Multiple	[7.5x]	During the last boot-up, your system hung for an		
System/PCI Frequency (MHz)	[133/33]			
System/SDRAM Frequency Ratio	[Auto]			

Cause for Hangup: Improper CPU Speed

AwardBIOS Setup Utility				
Main	Advanced	Power	Boot	Exit
CPU Speed	[Manual]	Item Specific Help		
CPU: System Frequency Multiple	[7.5x]	During the last boot-up, your system hung for		
System/PCI Frequency (MHz)	[133/33]			
System/SDRAM Frequency Ratio	[Auto]			

**Cause for Hangup: Improper CPU: System Frequency Multiple
(For processors with unlocked frequency multiplier only)**

AwardBIOS Setup Utility				
Main	Advanced	Power	Boot	Exit
CPU Speed	[Manual]	Item Specific Help		
CPU: System Frequency Multiple	[7.5x]	During the last boot-up, your system hung for		
System/PCI Frequency (MHz)	[133/33]			
System/SDRAM Frequency Ratio	[Auto]			

Cause for Hangup: Improper System/SDRAM Frequency

4. BIOS SETUP

4.4.1 Chip Configuration

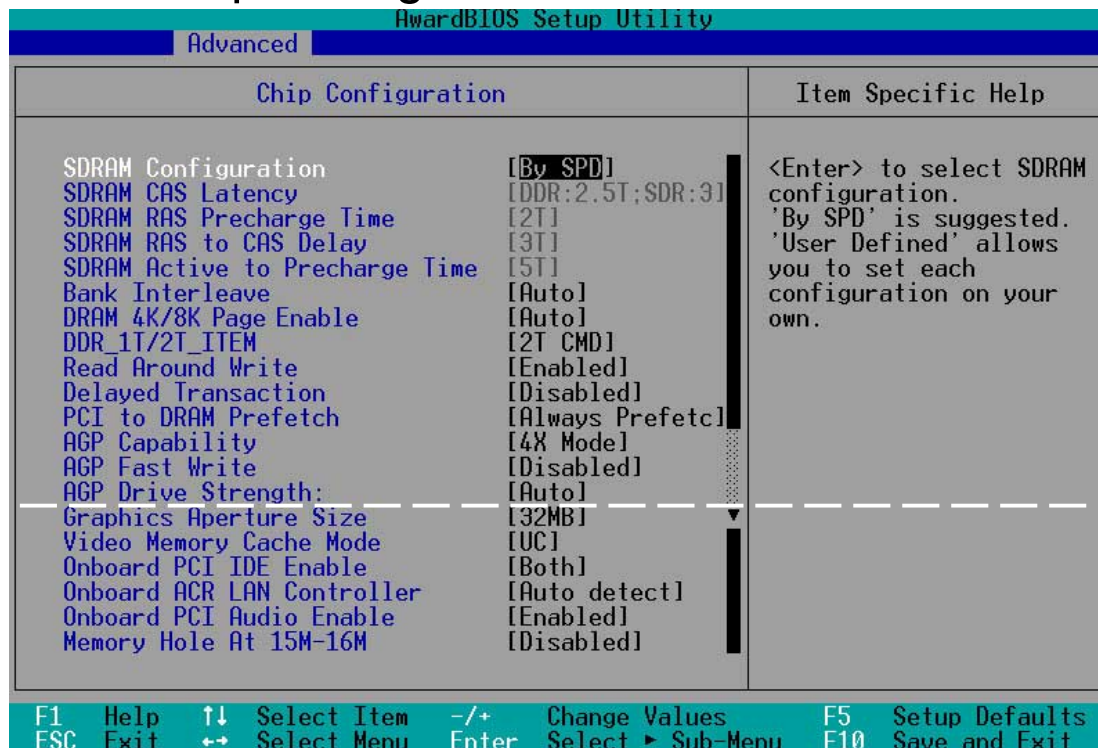

SDRAM Configuration [By SPD]

This sets the optimal timings for items 2–5, depending on the memory modules that you are using. The default setting is [By SPD], which configures items 2–5 by reading the contents in the SPD (Serial Presence Detect) device. The EEPROM on the memory module stores critical parameter information about the module, such as memory type, size, speed, voltage interface, and module banks. Configuration options: [User Defined] [7ns (143MHz)] [8ns (125MHz)] [By SPD]

SDRAM CAS Latency [DDR:2.5T;SDR:3]

This controls the latency between the SDRAM read command and the time that the data actually becomes available. **NOTE:** This field appears only when you set the **SDRAM Configuration** to [User Defined]. Configuration options: [DDR:2.5T;SDR:3T] [2T]

SDRAM RAS Precharge Time [2T]

This controls the idle clocks after issuing a precharge command to the SDRAM. **NOTE:** This field appears only when you set the **SDRAM Configuration** to [User Defined]. Configuration options: [3T] [2T]

SDRAM RAS to CAS Delay [3T]

This controls the latency between the SDRAM active command and the read/write command. **NOTE:** This field appears only if the **SDRAM Configuration** is set: [User Defined]. Configuration options: [3T] [2T]

4. BIOS SETUP

SDRAM Active to Precharge Time [6T]

To make changes to this field, set the SDRAM Configuration field to [User Defined]. Configuration options: [6T] [5T]A7V

Bank Interleave [Auto]

Configuration options: [None] [2 Banks] [4 Banks] [Auto]

DRAM 4K/8K Page Enable [Auto]

Configuration options: [Auto] [4K page enable] [8K page enable]

DDR_1T/2T_ITEM [2T CMD]

Configuration options: [1T CMD] [2T CMD] [Auto Mode]

Burst Len [Auto]

The DRAM burst length supports 8QW and 4QW. The default [Auto] detects the appropriate setting. Configuration options: [Auto] [4]

Read Around Write [Enabled]

Setting this field to [Enabled] allows the memory controller to store write data in its buffer whenever the CPU issues a write command. The next time the CPU needs the data, it retrieves the data from the memory buffer without accessing the SDRAM. Configuration options: [Disabled] [Enabled]

Delayed Transaction [Disabled]

When set to [Enabled], this feature frees the PCI bus when the CPU is accessing 8-bit ISA cards. This process normally consumes about 50-60 PCI Clocks without PCI delayed transaction. Set this field to [Disabled] when using ISA cards that are not PCI 2.1 compliant. Configuration options: [Enabled] [Disabled]

PCI to DRAM Prefetch [Always prefetc]

Configuration options: [Always Prefetch] [Prefetch disabled] [Prefetch only enhance command]

AGP Capability [4X Mode]

This motherboard supports the AGP 4x interface that transfers video data at 1066MB/s. AGP 4x is backward-compatible, so you may leave the default [4X Mode] on even if you are using an AGP 1x or 2x video card. When set to [1X Mode], the AGP interface only provides a peak data throughput of 266MB/s even if you are using an AGP 2x/4x card. When set to [2X Mode], the AGP interface only provides a peak data throughput of 533MB/s even if you are using an AGP 4x card. Configuration options: [1X Mode] [2X Mode] [4X Mode]

AGP Fast Write [Disabled]

Configuration options: [Disabled] [Enabled]

4. BIOS SETUP

AGP Drive Strength [Auto]

Configuration options: [Auto] [Manual]

Graphics Aperture Size [32MB]

This feature allows you to select the size of mapped memory for AGP graphic data. Configuration options: [4MB] [8MB] [16MB] [32MB] [64MB] [128MB] [256MB]

Video Memory Cache Mode [UC]

USWC (uncacheable, speculative write combining) is a new cache technology for the video memory of the processor. It can greatly improve the display speed by caching the display data. You must set this to UC (uncacheable) if your display card does not support this feature, otherwise the system may not boot. Configuration options: [UC] [USWC]

Onboard PCI IDE Enable [Both]

This field allows enable either the primary IDE channel or secondary IDE channel, or both. You can also set both channels to [Disabled]. Configuration options: [Both] [Primary] [Secondary] [Disabled]

Onboard ACR LAN Enable [Auto Detect]

This field enables or disable the onboard Advanced Communication Riser (ACR) and Local Area Network (LAN) controller built-in the VT8233 chipset. Configuration options: [Enabled] [Auto Detect] [Disabled]

Onboard PCI Audio Enable [Enabled]

This field enables PCI audio. Configuration options: [Enabled] [Disabled]

Memory Hole At 15M-16M [Disabled]

This field reserves an address space for ISA expansion cards. Setting the address space to a particular setting makes that memory space unavailable to other system components. Expansion cards can only access memory up to 16MB. Configuration options: [Disabled] [Enabled]

4. BIOS SETUP

4.4.2 I/O Device Configuration

AwardBIOS Setup Utility	
Advanced	
I/O Device Configuration	Item Specific Help
Onboard FDC Swap A & B [No Swap]	<Enter> to select if switch drive letter assignments or not.
Onboard Serial Port 1 [3F8H/IRQ4] Onboard Serial Port 2 [2F8H/IRQ3] UART2 Use [Com Port]	
Onboard Parallel Port [378H/IRQ7] Parallel Port Mode [ECP+EPP] ECP DMA Select [3]	
▶ Onboard Peripheral Resource Control	
Onboard CIR I/O [Disabled]	

F1 Help ↑↓ Select Item -/+ Change Values F5 Setup Defaults
ESC Exit ↔ Select Menu Enter Select ▶ Sub-Menu F10 Save and Exit

Onboard FDC Swap A & B [No Swap]

This field allows you to reverse the hardware drive letter assignments of your floppy disk drives. Configuration options: [No Swap] [Swap AB]

Onboard Serial Port 1 [3F8H/IRQ4]

Onboard Serial Port 2 [2F8H/IRQ3]

These fields allow you to set the addresses for the onboard serial connectors. Serial Port 1 and Serial Port 2 must have different addresses. Configuration options: [3F8H/IRQ4] [2F8H/IRQ3] [3E8H/IRQ4] [2E8H/IRQ10] [Disabled]

UART2 Use [COM Port]

This field can activate the onboard standard infrared feature and sets the second serial UART to support the infrared module connector on the motherboard. It also may be used to configure another COM port or to support a serial smart card reader. See **IrDA-Compliant Infrared Module Connector** in **3.8 Connectors**. Configuration options: [COM Port] [IR] [Smart Card Reader]

Onboard Parallel Port [378H/IRQ7]

This field sets the address of the onboard parallel port connector. If you disable this field, the **Parallel Port Mode** and **ECP DMA Select** configurations are not available. Configuration options: [Disabled] [378H/IRQ7] [278H/IRQ5]

4. BIOS SETUP

Parallel Port Mode [ECP+EPP]

This field allows you to set the operation mode of the parallel port. [Normal] allows normal-speed operation but in one direction only; [EPP] allows bidirectional parallel port operation; [ECP] allows the parallel port to operate in bidirectional DMA mode; [ECP+EPP] allows normal speed operation in a two-way mode. Configuration options: [Normal] [EPP] [ECP] [ECP+EPP]

ECP DMA Select [3]

This field allows you to configure the parallel port DMA channel for the selected **ECP** mode. This selection is available only if you select [ECP] or [ECP+EPP] in **Parallel Port Mode** above. Configuration options: [1] [3] [Disabled]

Onboard CIR I/O [Disabled]

This field allows you to select the I/O address and IRQ for consumer infrared device. Configuration options: [Disabled] [2E0-2E8H] [3E0-3E8H]

Onboard Peripheral Resource Control

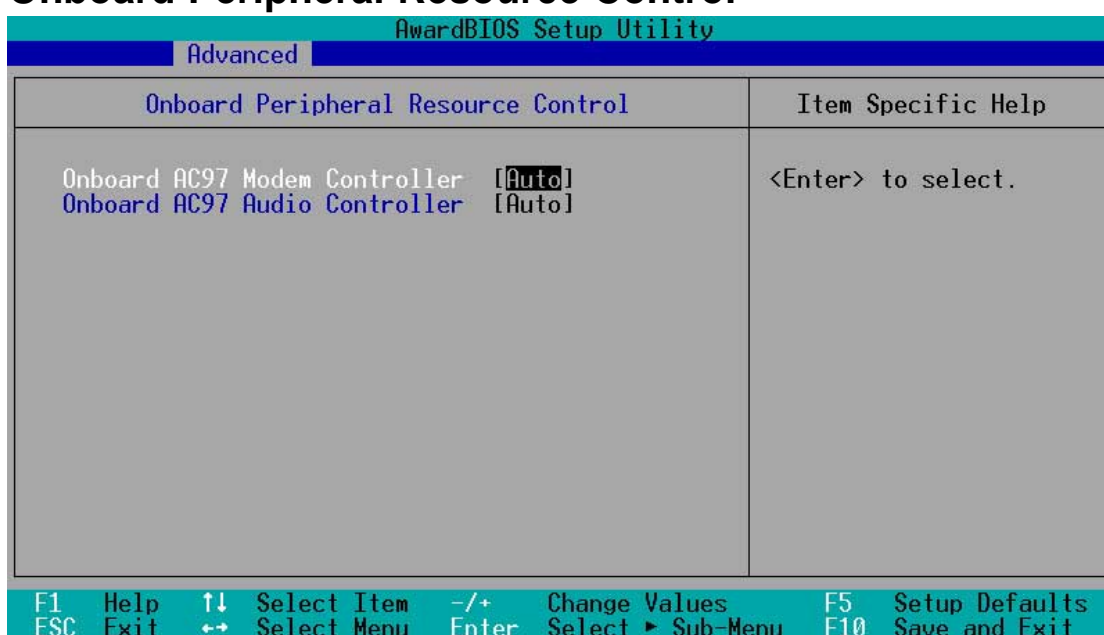

Onboard AC97 Modem Controller [Auto]

Onboard AC97 Audio Controller [Auto]

[Auto] allows the BIOS to detect whether you are using any modem/audio device. If a modem/audio device is detected, the onboard modem/audio controller is enabled; if no modem/audio device is detected, the controller is disabled. If there are conflicts with the onboard modem/audio controller, set the appropriate field to [Disabled]. Configuration options: [Disabled] [Auto]

4. BIOS SETUP

4.4.3 PCI Configuration

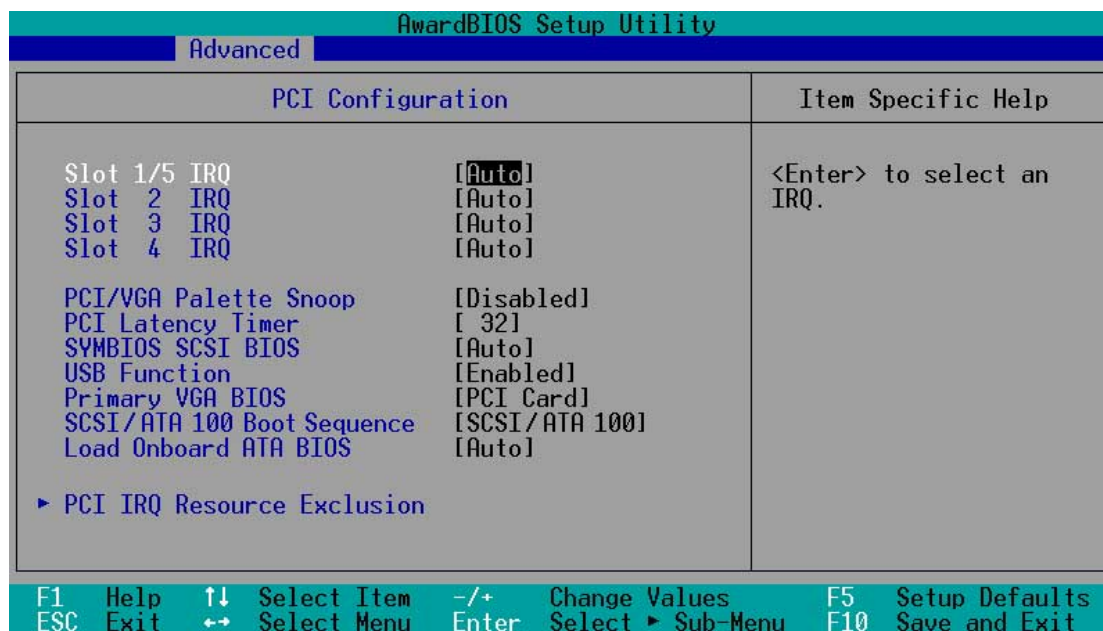

Slot 1, Slot 2, Slot 3, Slot 4/5 IRQ [Auto]

These fields automatically assign the IRQ for each PCI slot. The default setting for each field is [Auto], which utilizes auto-routing to determine IRQ assignments. Configuration options: [Auto] [NA] [3] [4] [5] [7] [9] [10] [11] [12] [14] [15]

PCI/VGA Palette Snoop [Disabled]

Some non-standard VGA cards, such as graphics accelerators or MPEG video cards, may not show colors properly. Setting this field to [Enabled] corrects this problem. If you are using standard VGA cards, leave this field to the default setting [Disabled]. Configuration options: [Disabled] [Enabled]

PCI Latency Timer [32]

Leave this field to the default setting [32] for best performance and stability.

SYMBIOS SCSI BIOS [Auto]

[Auto] allows the BIOS to detect whether you have a SYMBIOS SCSI card. If such card is detected, the SCSI BIOS is enabled. Otherwise, the onboard SCSI BIOS is disabled.

The setting [Disabled] disables the onboard SYMBIOS SCSI BIOS so that the BIOS on an add-on SYMBIOS SCSI card can be used. If the SYMBIOS SCSI card does not have a BIOS, the Symbios SCSI card will not work. Configuration options: [Auto] [Disabled]

4. BIOS SETUP

USB Function [Enabled]

Set this field to [Enabled] if you want to use Universal Serial Bus (USB) devices. Configuration options: [Disabled] [Enabled]

Primary VGA BIOS [PCI Card]

This field allows you to select the primary graphics card. Configuration options: [PCI Card] [AGP Card]

SCSI/ATA100 Boot Sequence [ATA100/SCSI]

This field sets the priority of boot sequencing for either the ATA100 or the SCSI controller. Configuration options: [ATA100/SCSI] [SCSI/ATA100]

Load Onboard ATA BIOS [Auto]

This field sets the priority of the onboard Promise controller BIOS. The default automatically displays the Promise ATA BIOS at start up. Selecting [Disable] or resetting the RAID_EN jumper overrides the ATA BIOS and skips detection of arrays. Configuration options: [Auto] [Disabled]

PCI IRQ Resource Exclusion

The screenshot shows the 'AwardBIOS Setup Utility' interface. At the top, there is a blue bar with 'AwardBIOS Setup Utility' and a sub-menu 'Advanced'. Below this is a table titled 'PCI IRQ Resource Exclusion' with two columns: 'Item Specific Help' and a list of IRQ settings. The settings are as follows:

IRQ	Used By	ISA	[No/ICU]
IRQ 3	Used By	ISA	[No/ICU]
IRQ 4	Used By	ISA	[No/ICU]
IRQ 5	Used By	ISA	[No/ICU]
IRQ 7	Used By	ISA	[No/ICU]
IRQ 9	Used By	ISA	[No/ICU]
IRQ 10	Used By	ISA	[No/ICU]
IRQ 11	Used By	ISA	[No/ICU]
IRQ 12	Used By	ISA	[No/ICU]
IRQ 14	Used By	ISA	[No/ICU]
IRQ 15	Used By	ISA	[No/ICU]

The 'Item Specific Help' column contains the text: 'Select [Yes] if this IRQ is required by a legacy ISA card and you are not using ICU; otherwise, select [No/ICU].'

At the bottom of the screenshot, there is a legend for navigation keys:

F1	Help	↑↓	Select Item	-/+	Change Values	F5	Setup Defaults
ESC	Exit	←→	Select Menu	Enter	Select ► Sub-Menu	F10	Save and Exit

IRQ XX Used By ISA [No/ICU]

These fields indicate whether or not the displayed IRQ for each field is being used by a legacy (non-PnP) ISA card. The setting [No/ICU] for an IRQ field indicates that you are using the ISA Configuration Utility (ICU), and that this particular IRQ is NOT required by a legacy ISA card. Set the IRQ field to [Yes] if you install a legacy ISA card that requires a unique IRQ and you are NOT using ICU. Configuration options: [No/ICU] [Yes]

4. BIOS SETUP

4.5 Power Menu

The Power menu allows you to reduce power consumption. This feature turns off the video display and shuts down the hard disk after a period of inactivity.

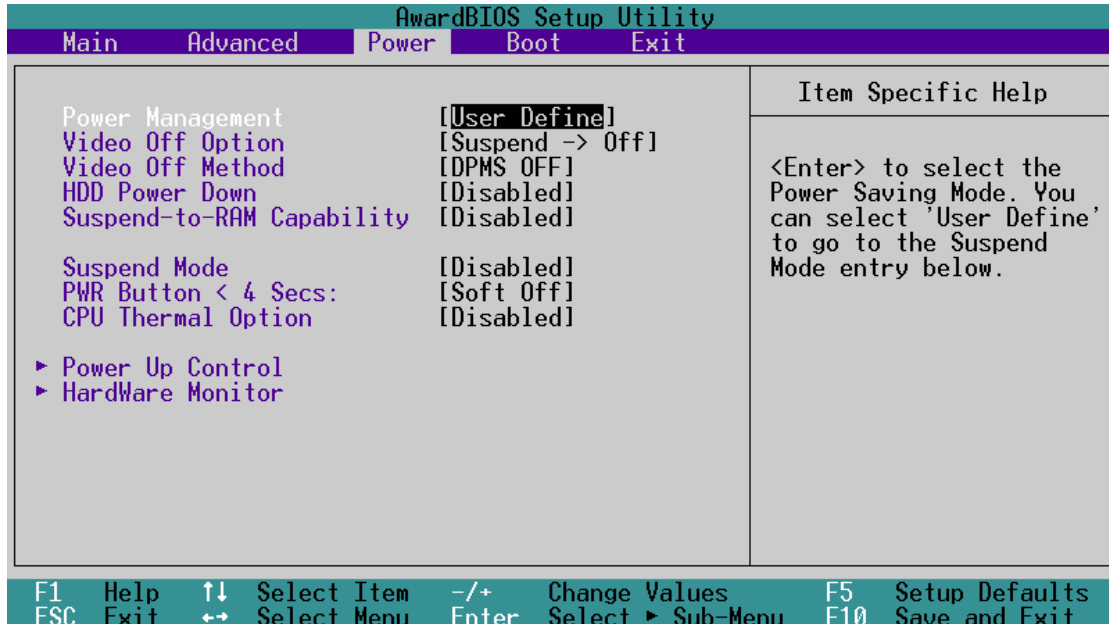

Power Management [User Defined]

This field must be enabled to activate the automatic power saving features. When set to [Disabled], the power management features do not function regardless of the other settings on this menu. The [User Defined] option allows you to make your own selections in the Power menu. When set to [Max Saving], system power conserved to its greatest amount. The **Suspend Mode** field is then be set to a predefined value that ensures maximum power savings.

This field acts as the master control for the power management modes. [Max Saving] puts the system into power saving mode after a brief period of system inactivity. [Min Saving] is almost the same as [Max Saving] except that the system inactivity period is longer. [Disabled] deactivates the power saving features, [User Defined] allows you to set power saving options according to your preference. Configuration options: [User Defined] [Disabled] [Min Saving] [Max Saving]

IMPORTANT: You should install the Advanced Power Management (APM) utility to keep the system time updated even when the computer enters suspend mode. In DOS environment, you need to add the statement, DEVICE=C:\DOS\POWER.EXE, to the CONFIG.SYS file. In Windows 3.x and Windows 95, you need to install Windows with the APM feature. In Windows 98 or later, APM is automatically installed as indicated by a battery and power cord icon labeled “Power Management” in the “Control Panel.” Select the item “Advanced” in the Power Management Properties dialog box.

4. BIOS SETUP

Video Off Option [Suspend -> Off]

This field determines when to activate the video off feature for monitor power management. Configuration options: [Always On] [Suspend -> Off]

Video Off Method [DPMS OFF]

This field defines the video off features. The DPMS (Display Power Management System) feature allows the BIOS to control the video display card if it supports the DPMS feature. [Blank Screen] only blanks the screen (use this for monitors without power management or “green” features. If set up in your system, your screen saver will not display with [Blank Screen] selected). [V/H SYNC+Blank] blanks the screen and turns off vertical and horizontal scanning. Configuration options: [Blank Screen] [V/H SYNC+Blank] [DPMS Standby] [DPMS Suspend] [DPMS OFF] [DPMS Reduce ON]

HDD Power Down [Disabled]

Shuts down any IDE hard disk drives in the system after a period of inactivity as set in this user-configurable field. This feature does not affect SCSI hard drives. Configuration options: [Disabled] [1 Min] [2 Min] [3 Min]...[15 Min]

Suspend-to-RAM Capability [Disabled]

This field lets you to enable or disable the Suspend-to-RAM (STR) feature allowing the system to go into suspend mode after the specified time in the Suspend Mode parameter. Configuration options: [Disabled] [enabled]

Suspend Mode [Disabled]

Sets the time period before the system goes into suspend mode. Configuration options: [Disabled] [30 Sec] [1 Min] [2 Min]...[1 Hour]

PWR Button < 4 Secs [Soft Off]

When set to [Soft off], the ATX switch can be used as a normal system power-off button when pressed for less than 4 seconds. [Suspend] allows the button to have a dual function where pressing less than 4 seconds will place the system in sleep mode. Regardless of the setting, holding the ATX switch for more than 4 seconds will power off the system. Configuration options: [Soft off] [Suspend]

CPU Thermal Option [Throttle]

Configuration options: [Throttle] [Shutdown]

4. BIOS SETUP

4.5.1 Power Up Control

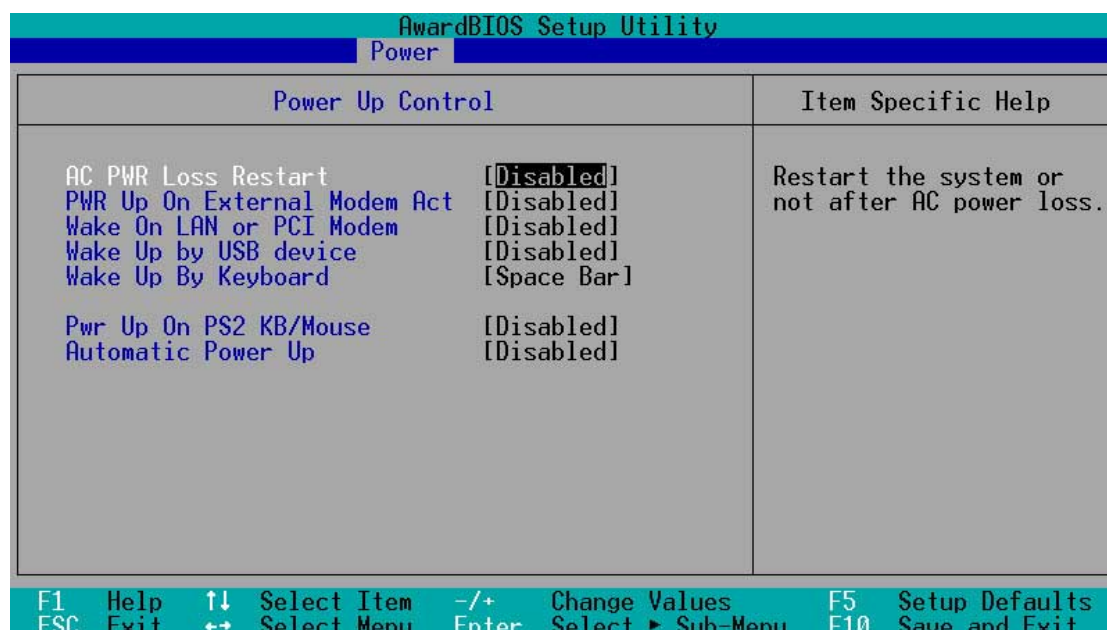

AC PWR Loss Restart [Disabled]

This allows you to set whether you want your system to reboot after the power has been interrupted. [Disabled] leaves your system off and [Enabled] reboots your system. [Previous State] sets your system back to the state it is before the power interruption. Configuration options: [Disabled] [Enabled] [Previous State]

PWR Up On External Modem Act [Disabled]

This allows either settings of [Enabled] or [Disabled] for powering up the computer when the external modem receives a call while the computer is in Soft-off mode. **NOTE:** The computer cannot receive or transmit data until the computer and applications are fully running. Thus connection cannot be made on the first try. Turning an external modem off and then back on while the computer is off causes an initialization string that will also cause the system to power on. Configuration options: [Disabled] [Enabled]

Wake On LAN or PCI Modem [Disabled]

Wake-On-LAN/PCI Modem allows your computer to be booted from another computer via a network by sending a wake-up frame or signal. Configuration options: [Disabled] [Enabled]

IMPORTANT: This feature requires an optional network interface with Wake-On-LAN and an ATX power supply with at least 720mA +5V standby power.

4. BIOS SETUP

Wake Up by USB Device [Disabled]

When set to [Enabled], this field allows you to wake up the system by a USB device activity. This feature requires an ATX power supply that can supply at least 1A on the +5VSB lead. The default is [Disabled] because not all computer have the appropriate power supply. A computer without the correct power supply will power up if you set this field to [Enabled]. Configuration options: [Disabled] [Enabled]

Wake Up by Keyboard [Space Bar]

This parameter allows you to use specific keys on the keyboard to power up the computer. Configuration options: [Space Bar] [Ctrl-Esc] [Power Key]

Power Up on PS2 KB/Mouse [Disabled]

Set this field to [Enabled] if you want to use your PS/2 keyboard or PS/2 mouse to power up the computer. This feature requires an ATX power supply that can supply at least 300mA on the +5VSB lead. The default is [Disabled] because not all computer have the appropriate power supply. Configuration options: [Disabled] [Enabled]

Automatic Power Up [Disabled]

This allows an unattended or automatic system power up. You may configure your system to power up at a certain time of the day by selecting [Everyday] or at a certain time and day by selecting [By Date]. Configuration options: [Disabled] [Everyday] [By Date]

4. BIOS SETUP

4.5.2 Hardware Monitor

AwardBIOS Setup Utility		
Power		
Hardware Monitor	Item Specific Help	
MB Temperature	33°C/91°F	<Enter> to switch between Monitoring or Ignore.
CPU Temperature	61°C/141°F	
JTPWR Temperature	[Ignore]	
CPU Fan Speed	7500RPM	
Power Fan Speed	7670RPM	
Chassis Fan Speed	N/A	
VCORE Voltage	1.52V	
+3.3V Voltage	3.33V	
+5V Voltage	5.00V	
+12V Voltage	12.00V	
F1 Help ↑↓ Select Item -/+ Change Values F5 Setup Defaults		
ESC Exit ↔ Select Menu Enter Select ▶ Sub-Menu F10 Save and Exit		

MB Temperature [xxxC/xxxF]

CPU1/CPU2 Temperature [xxxC/xxxF]

JTPWR Temperature [xxxC/xxxF]

The onboard hardware monitor automatically detects the MB (motherboard), CPU, and JTPWR (power supply) temperatures.

CPU Fan Speed [xxxxRPM]

Power Fan Speed [xxxxRPM]

Chassis Fan Speed [N/A]

The onboard hardware monitor automatically detects the speeds of the CPU fan, chassis fan, and chassis fan measured in rotations per minute (RPM).

VCORE1/VCORE2 Voltage

+3.3V Voltage, +5V Voltage, +12V Voltage

The onboard hardware monitor automatically detects the voltage output through the onboard voltage regulators.

NOTE: If any of the monitored items is out of range, the following error message appears: “Hardware Monitor found an error. Enter Power setup menu for details”. You will then be prompted to “Press **F1** to continue or **DEL** to enter SETUP”.

4. BIOS SETUP

4.6 Boot Menu

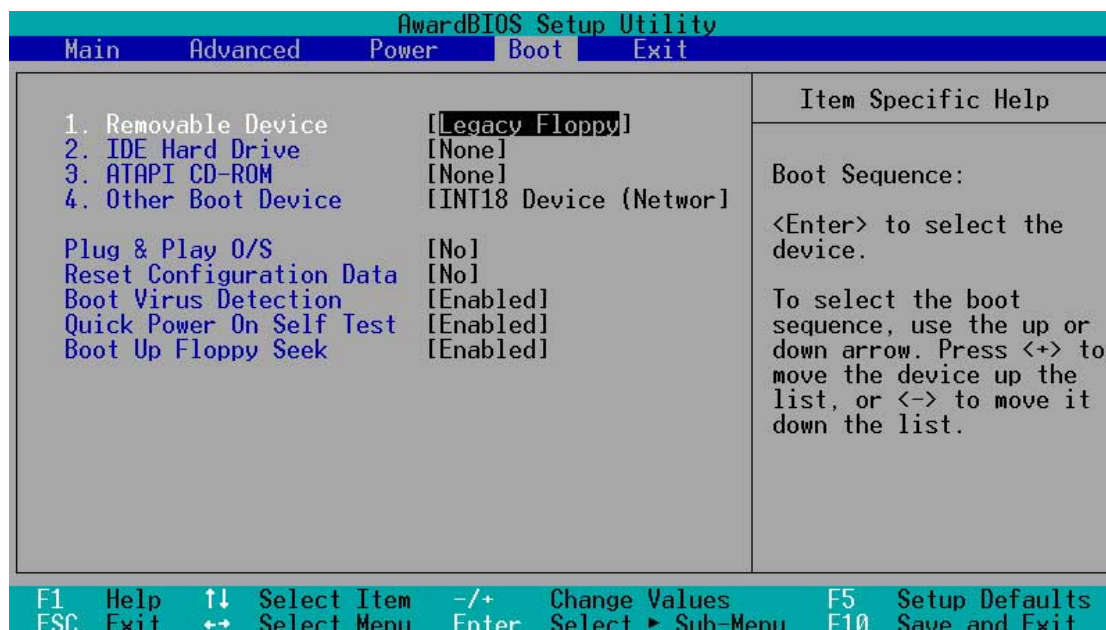

Boot Sequence

The Boot menu allows you to select among the four possible types of boot devices listed using the up and down arrow keys. By using the <+> or <Space> key, you can promote devices and by using the <-> key, you can demote devices. Promotion or demotion of devices alters the priority which the system uses to search for a boot device on system power up. Configuration fields include **Removable Devices**, **IDE Hard Drive**, **ATAPI CD-ROM**, and **Other Boot Device**.

Removable Device [Legacy Floppy]

Configuration options: [Disabled] [Legacy Floppy] [LS120] [ZIP] [ATAPI MO]

IDE Hard Drive

This field allows you to select which IDE hard disk drive to use in the boot sequence. Pressing [Enter] will show the product IDs of all connected IDE hard disk drives.

ATAPI CD-ROM

This field allows you to select which ATAPI CD-ROM drive to use in the boot sequence. Pressing [Enter] will show the product IDs of all your connected ATAPI CD-ROM drives.

Other Boot Device Select [INT18 Device (Network)]

Configuration options: [Disabled] [SCSI Boot Device] [INT18 Device (Network)]

4. BIOS SETUP

Plug & Play O/S [No]

This field allows you to use a Plug-and-Play (PnP) operating system to configure the PCI bus slots instead of using the BIOS. When [Yes] is selected, interrupts may be reassigned by the OS. When a non-PnP OS is installed or you want to prevent reassigning of interrupt settings, select the default setting of [No]. Configuration options: [No] [Yes]

Reset Configuration Data [No]

The Extended System Configuration Data (ESCD) contain information about non-PnP devices. It can also hold the complete record of how the system was configured the last time it was booted. Select [Yes] only if you want to clear these data during the Power-On Self Test (POST). Configuration options: [No] [Yes]

Boot Virus Detection [Enabled]

This field allows you to set boot virus detection, ensuring a virus-free boot sector. The system halts and displays a warning message when it detects a virus. If this occurs, you can either allow the operation to continue or use a virus-free bootable floppy disk to restart and investigate your system. Configuration options: [Disabled] [Enabled]

Quick Power On Self Test [Enabled]

This field speeds up the Power-On-Self Test (POST) routine by skipping retesting a second, third, and fourth time. Configuration options: [Disabled] [Enabled]

Boot Up Floppy Seek [Enabled]

When enabled, the BIOS will seek the floppy disk drive to determine whether the drive has 40 or 80 tracks. Configuration options: [Disabled] [Enabled]

4. BIOS SETUP

4.7 Exit Menu

When you have made all of your selections from the various menus in the Setup program, save your changes and exit Setup. Select **Exit** from the menu bar to display the following menu:

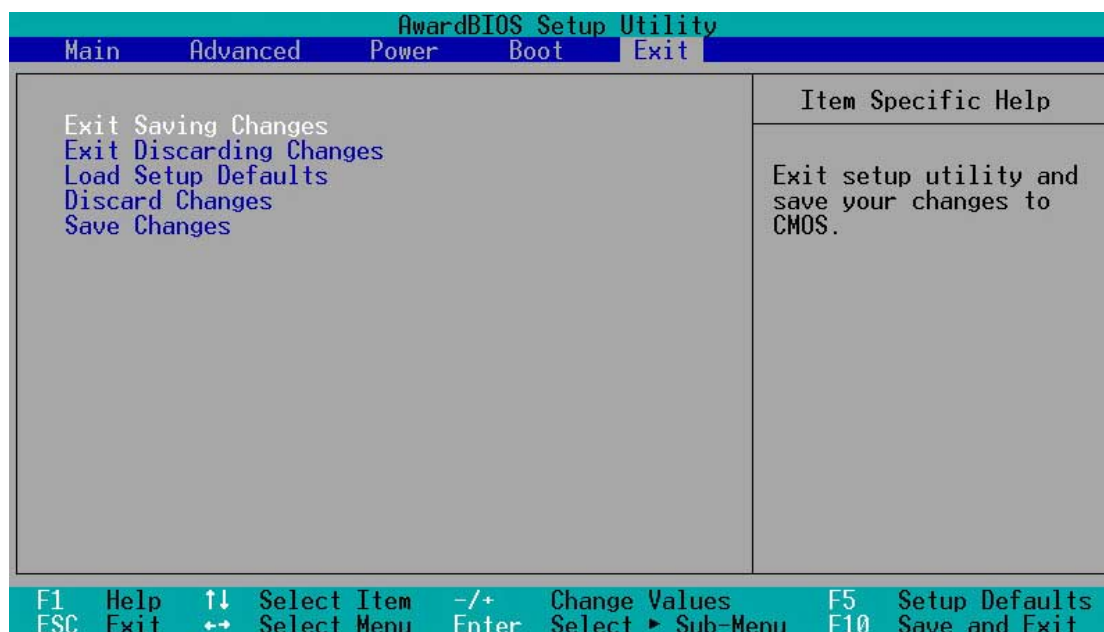

NOTE: Pressing <Esc> does not immediately exit this menu. Select one of the options from this menu or <F10> from the legend bar to exit this menu.

Exit Saving Changes

Once you are finished making your selections, choose this option from the Exit menu to ensure the values you selected are saved to the CMOS RAM. The CMOS RAM is sustained by an onboard backup battery and stays on even when the PC is turned off. When you select this option, a confirmation window appears. Select [Yes] to save changes and exit.

NOTE: If you attempt to exit the Setup program without saving your changes, the program prompts you with a message asking if you want to save your changes before exiting. Pressing <Enter> saves the changes while exiting.

Exit Discarding Changes

Select this option only if you do not want to save the changes that you made to the Setup program. If you made changes to fields other than system date, system time, and password, the BIOS asks for a confirmation before exiting.

4. BIOS SETUP

Load Setup Defaults

This option allows you to load the default values for each of the parameters on the Setup menus. When you select this option or if you press <F5>, a confirmation window appears. Select [Yes] to load default values. Select **Exit Saving Changes** or make other changes before saving the values to the non-volatile RAM.

Discard Changes

This option allows you to discard the selections you made and restore the previously saved values. After selecting this option, a confirmation appears. Select [Yes] to discard any changes and load the previously saved values.

Save Changes

This option saves your selections without exiting the Setup program. You can then return to other menus and make further changes. After you select this option, a confirmation window appears. Select [Yes] to save any changes to the non-volatile RAM.

4. BIOS SETUP

(This page was intentionally left blank.)

5. SOFTWARE SETUP

5.1 Install Operating System

You should always use the latest operating system and updates when using new hardware to ensure full compliancy. You may use any version of Windows 98/2000/Millennium, but for Windows 95, you must use OSR 2.0 or later. For Windows NT 4.0, you must use Service Pack 3.0 or later.

NOTE: To configure your system to use the RAID 0 or 1 option, you must run the FastTrack133™ BIOS before installing the OS. Normally, this firmware will be activated automatically upon first boot-up. If not, double check: 1) the RAID_EN jumper, and 2) the BIOS default in the PCI Configuration sub-menu under the Advanced menu: the “SCSI/Promise Boot Sequence” field should be set to [Promise/SCSI] and the “Load Onboard ATA BIOS” field should be [Enabled].

5.2 Start Windows

When you start Windows 98 for the first time after installing your motherboard, Windows will detect all plug-and-play devices. Follow the Add New Hardware Wizard to install all necessary device drivers. The system should auto-detect the Promise Chip and the user should browse the support CD to install the RAID *driver*, in the Promise driver folder: PDC20267. When prompted to restart, select **No** and then follow all the setup procedures in this section.

NOTE: Because there are various motherboard settings, options, and expansion cards, the following can only be used as a general reference and may not reflect exactly the screen contents displayed on your screen.

5. SOFTWARE SETUP

5.3 A7V266-EX Motherboard Support CD

NOTE: The support CD contents are subject to change at any time without notice.

To begin using your support CD disc, just insert it into your CD-ROM drive and the support CD installation menu should appear. If the menu does not appear, double-click or run **D:\ASSETUP.EXE** (assuming that your CD-ROM drive is drive **D:**).

5.3.1 Installation Menu

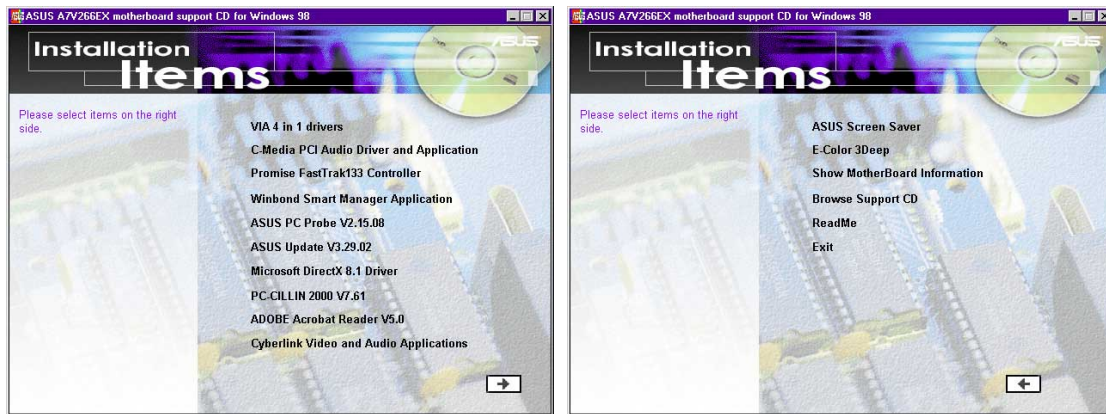

- **VIA 4 in 1 drivers:** Installs PCI Bus Master IDE Driver, VIA AGP Driver, VIA INF Driver, and IRQ Routing Driver.
- **C-Media PCI Audio Driver and Application:** Installs the drivers for the C-Media Audio Driver and the sound system to support the C-Media Audio Chip and HRTF 3D Audio circuitry.
- **Promise FastTrack133 Controller:** Installs the Promise Ultra 133 IDE Controller Driver.
- **Winbond Smart Manager Application:** Installs the Winbond Smart Card management application program.
- **ASUS PC Probe:** Installs a smart utility to monitor your computer's fan, temperature, and voltages.
- **ASUS Update:** Installs a program that can help you update BIOS or download a BIOS image file.
- **Microsoft DirectX Driver:** Installs basic drivers to enable compatibility with audio and other special functions.
- **PC-Cillin 2000 Vx.xx:** Installs the PC-cillin virus protection software. View online help for more information.
- **ADOBE Acrobat Reader Vx.xx:** Installs the Adobe Acrobat Reader software necessary to view user's manuals saved in PDF format. Updated or other language versions of this motherboard's manual is available in PDF format at any of our web sites.
- **Cyberlink Video and Audio Applications:** Installs Cyberlink PowerPlayer SE and Cyberlink VideoLive Mail.

(TO SEE THE NEXT PAGE, CLICK RIGHT ARROW ON THE LOWER-RIGHT CORNER OF THE MAIN MENU)

5. SOFTWARE SETUP

- **ASUS Screen Saver:** Installs the nifty ASUS screen saver.
- **E-Color 3Deep:** Installs graphical driver and an application for tuning the quality of color output from CRT and LCD monitors.
- **Show Motherboard Information:** Allows you to view information about your motherboard, such as product name, BIOS version, and CPU.
- **Browse Support CD:** Allows you to view the contents of the CD.
- **ReadMe:** Allows you to view the support CD file list and contact information.
- **Exit:** Exits the CD installation menu.

(RETURN TO THE MAIN MENU, CLICK LEFT ARROW ON THE LOWER-RIGHT CORNER)

5. SOFTWARE SETUP

5.4 Using the Promise Chip for RAID 0 or 1

The Promise® chip, PDC20276, onboard the A7V266-EX, offers a high performance Redundant Array of Independent Disks (RAID) configuration that supports *only* UltraDMA-133/100/66/33, EIDE or FastATA-2 hard disks. After connecting two hard disks to the motherboard, activating either RAID 0 or 1 function is easily configured through the *MBMBMBFastTrak133™* “Lite” firmware BIOS during boot up. In addition, the support CD permits installation of system drivers according to the Operating System (OS) on your computer. Read through this section in its entirety before setting up a new RAID system.

RAID 0 is also known as “data striping.” Striping optimizes two identical hard disk drives to read and write data in parallel, interleaved stacks. Two hard disks perform the same work as a single drive, and at a sustained data transfer rate double that of a single disk alone. The main advantage of a RAID 0 array is to improve the ***Speed Performance*** of data access and storage. With FAT32 and NTFS partitioning, the array will be addressed as one large volume.

RAID 1 is also known as “data mirroring.” Mirroring optimizes two identical hard disk drives to copy all data from one hard disk drive to the other and vice versa. As new data is written, it is duplicated onto both disks using a parallel write process. The main advantage of RAID 1 is that it greatly increases ***Fault Tolerance*** of the entire system, especially if each hard disk is connected separately to both ATA-133 IDE channels available on the A7V266-EX. Should one hard disk suffer mechanical trouble, all system data will be preserved on the other drive.

IMPORTANT! Before setting up your new RAID array, verify the status of your hard disks. It is possible to use a pre-existing hard disk for RAID 0 only if the data is backed up before configuring the array as all hard disk data will be lost during the set up. RAID 0 requires at least two hard disks for optimal results. It is possible to use a pre-existing hard disk for RAID 1 to duplicate the source data; also, RAID 1 can set up two or more new disks. The Promise® chip, the *FastTrak™* “Lite” BIOS and the *FastBuild™* Utility on the A7V266-EX permit only *two* disks to be configured in RAID 0 or RAID 1 pairs and combinations; a third, “hot” spare hard disk may be used to support a RAID 1 array; (*see the end of this section for more detail*). For optimal performance, install only identical hard disks of the same model and storage capacity. Use only UltraDMA-100/66 compatible IDE cables and connectors. The Promise® chip also supports UltraDMA-133 specifications of up to 133 MB/sec per disk, with or without multiple disk arrays up to four hard disks.

5. SOFTWARE SETUP

5.4.1 Installing the Hard Disks

The RAID 0 setting allows users to reformat two hard disks with the same new OS simultaneously. RAID 1 arrays can use a pre-existing hard disk along with a blank hard disk, or two new hard disks.

1. Install the first and second hard disk into the hard disk bays of your system. Connect each hard disk drive with a separate *UltraDMA/100* cable, one to the Promise IDE1 connector, and the other to the Promise IDE2 connector onboard the A7V266-EX. NOTE: Do not connect any other types of IDE devices to the Promise IDE connectors; they support hard disk drive devices only.
2. Connect the power cables to the hard disks.
3. Make sure the RAID_EN jumper is reset to [1-2] and, if available, ensure the BIOS settings in the *Advanced PCI Configuration* sub-menu are set to enable RAID arrays: “SCSI/ATA100 Boot Sequence” field should be set to [ATA100/SCSI] and the “Load Onboard ATA BIOS” field should be set to [Auto].
4. Boot-up the PC.

5.4.2 Enter MBFastTrak133 BIOS and FastBuild Utility

1. If this is the first time booting with two hard disks correctly installed, then MBFastTrak133™ “Lite” BIOS scans the IDE drives and displays this screen:

```
MBFastTrak133 (tm) "Lite" BIOS
(c) 1995-2000 Promise Technology, Inc. All Rights Reserved.

No Array is defined . . .

Press <Ctrl-F> to enter FastBuild (tm) Utility or
Press <ESC> to continue booting . . .
```

2. Press <Ctrl-F> keys to display the *FastBuild*™ Utility Main Menu:

```
FastBuild (tm) Utility 1.31 (c) 1996-2000 Promise Technology, Inc.
-----[ Main Menu ]-----

Auto Setup . . . . . [F1]
View Drive Assignments . . . . [F2]
View Array . . . . . [F3]
Delete Array . . . . . [F4]
Rebuild Array. . . . . [F5]
Controller Configuration . . . [F6]

-----[ Keys Available ]-----

Press 1..6 to select Option [ESC] Exit
```

5. SW SETUP
RAID

5. SOFTWARE SETUP

5.4.3 Creating a RAID 0 Array

1. In the *FastBuild™* Utility **Main Menu**, select **Auto Setup [1]**. The screen below is displayed. The **Auto Setup Options Menu** configures hard disks for RAID 0 and RAID 1 arrays. These selections assign all available drives that are appropriate for the new array and configures data formats and the IDE channels.

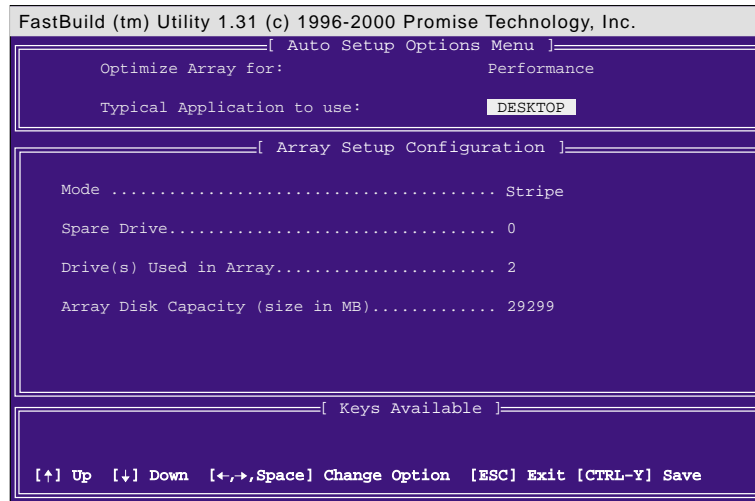

2. Go to the field **Optimize Array for:** and select **Performance** using the arrow and space keys. The **Mode** field displays **Stripe**.
3. Then go to the **Typical Application Menu**. Three options are available: **A/V Editing**, **DESKTOP**, or **Server**. These selections determine how data blocks are managed to enhance performance. *A/V Editing* is intended for audio/video applications, or similar programs that require larger file transfers; *Desktop* combines large and small file sizes; *Server* is for numerous file transfers.
4. After making the selection, use <Ctrl-Y> to save it. *FastBuild™* automatically constructs the RAID 0 array.
5. Then the command appears: “Press Any Key to Reboot.” Reboot the system and the *MBFastTrak133™* “Lite” BIOS checks and displays the status of the new array:

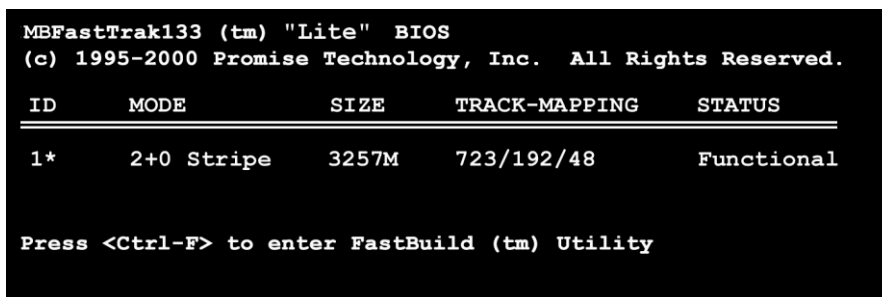

6. To finish installation of your new Operating System to the RAID 0 array, reboot with a floppy disk to format the hard disks with the *FDISK* command and then install the OS from a CD; alternatively, with a bootable OS CD, you may install the new OS automatically. As you install the OS, the system always treats the RAID 0 array of hard disks as if they are a single drive unit.

5. SOFTWARE SETUP

5.4.4 Creating a RAID 1 Array

1. In the *FastBuild™* Utility **Main Menu**, select *Auto Setup* [1].

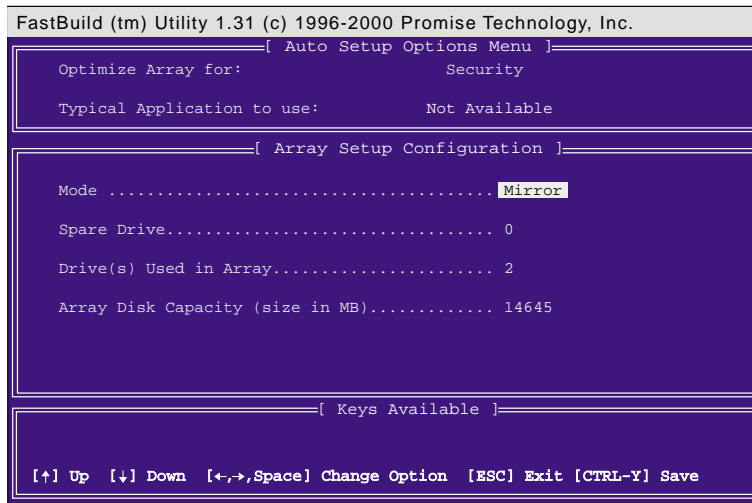

2. Go to the field **Optimize Array for:** and select *Security*. The **Mode** field displays *Mirror*.
3. After making the selection, use <Ctrl-Y> to save it. *FastBuild™* offers a choice between two options. Use <Y> for *Create and Duplicate* to mirror a pre-existing hard disk formatted with data that you want to save on both hard disks; (Go to step 4.) Use <N> for *Create Only* if using two new hard disks to configure a new RAID 1 mirrored array; (Go to step 6.)

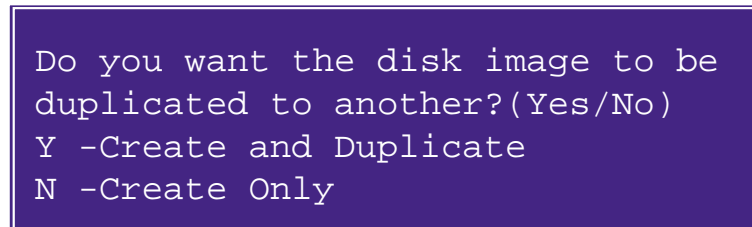

4. If selecting <Y>, for *Create and Duplicate*, this screen will be displayed:

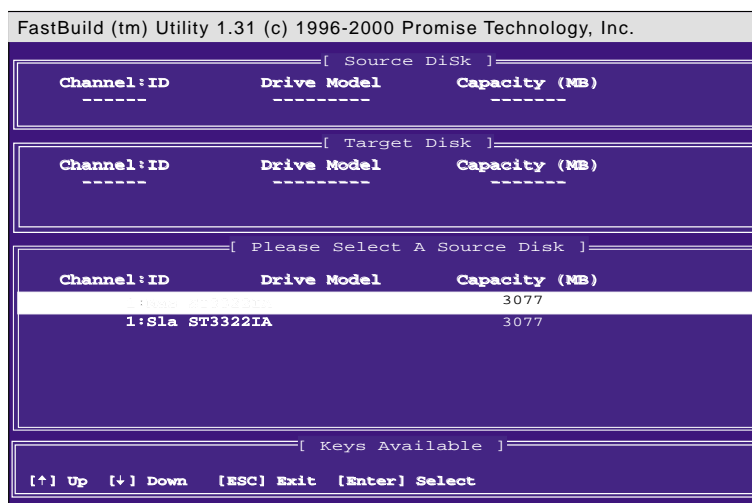

5. SOFTWARE SETUP

5. The utility prompts: *Please Select A Source Disk*. Choose the pre-existing hard disk as the source and then a new, blank hard disk as the target. Then select **<Ctrl-Y>** to save the selection. The utility prompts a choice between **<Y>** to continue and **<N>** to stop and escape. Choosing **<Y>** begins to duplicate the source hard disk onto the target hard disk.
6. To configure two new blank hard disks in a RAID 1 array, choose **<N>** for *Create Only*; (At step 3). The *FastBuild™* utility configures the RAID 1 array and a message appears: *Array has been created... <Press Any Key to REBOOT>*
7. Rebooting the system allows the *MBFastTrak133™* "Lite" BIOS to display the status of your new array:

```
MBFastTrak133 (tm) "Lite" BIOS
(c) 1995-2000 Promise Technology, Inc. All Rights Reserved.

ID      MODE          SIZE    TRACK-MAPPING  STATUS
-----
1*      1x2 Mirror     1628M   827/64/63      Functional

Press <Ctrl-F> to enter FastBuild (tm) Utility
```

8. If duplicating an original Operating System to another new hard disk, the system will start up automatically. If creating a brand new RAID 1 array only, it will be necessary to install a new OS. Reboot with a rescue floppy disk to format the hard disks with the *FDISK* command and then install the OS from a CD; alternatively, with a *bootable* OS CD, install the new OS automatically.

NOTES for Troubleshooting Array Set Ups:

Always use two separate UltraDMA/100 cables for linking each of two hard disks to the Primary DMA-100 and the Secondary DMA-100 connectors. Usually, a two disk array will set up properly if both sets of hard disk jumpers are set to *Master*. However, it may be necessary to reset the jumpers on each of the hard disks; in such cases, try *Master* for the *Source* disk, and *Master/Slave* or *Slave* for the *Target* disk. Also, if a Source hard disk larger than the Target disk is selected, the *FastBuild™* utility suggests using a larger or equal size disk for the Target instead. During reboots after configuring a RAID array, the IDE scan process determines if the system is working okay. Normally the *MBFastTrak133™* "Lite" BIOS displays system status as *Functional* after rebooting the new RAID array. However, two warnings may appear: *Critical* indicates that one or more drives in the array are not functional, or are disconnected. In this case, enter the *FastBuild™* Utility to diagnose the problem and replace the faulty drive. The second warning, *Offline*, indicates that one hard disks in a striped array has failed, cannot be detected, or has become disconnected. In this case, adjust or replace the hard disk if necessary and rebuild data from a back-up source.

5. SOFTWARE SETUP

5.4.5 Other FastBuild Utility Commands

Command options 3-6 on the *FastBuild*TM Utility **Main Menu** are not required for setting up an array, but they are useful for modifying or reconfiguring an array:

View Array (3): View the drive assignments of hard disks in an array.

Delete Array (4): Deletes an array to reconfigure the system. Deleting an array does not remove information on the hard disks. If an array is deleted by mistake, recover it immediately by redefining it as the deleted array.

Rebuild Array (5): This command restores the array and system data after faults on RAID 1 arrays. Follow the steps below to rebuild and restore data in the array:

1. On boot-up, an error message notifies of a system failure.
2. Press <Ctrl-F> keys to enter the *FastBuild*TM**Main Menu**.
3. Select <3> for **View Array** to verify the ID of the defunct hard disk.
4. Power off the system and replace the hard disk with an identical model.
5. Reboot and enter the *FastBuild*TM **Main Menu** again.
6. Select <5> for **Rebuild Array**. The malfunctioning array is highlighted.

Press <Enter> to select it:

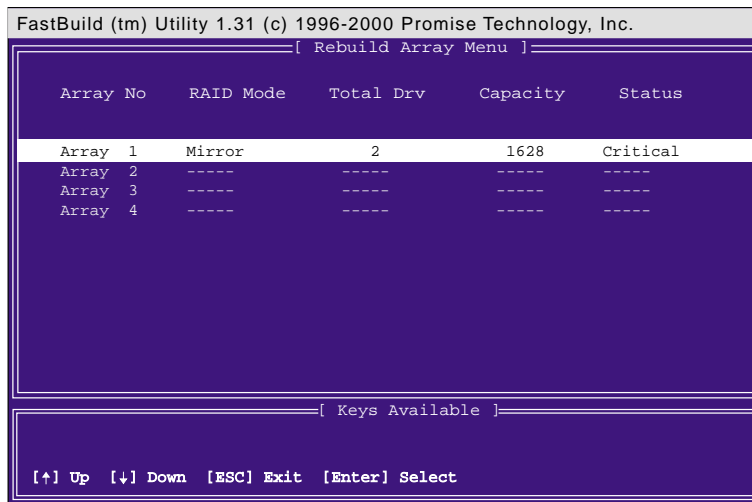

7. Select the replacement drive. Press <Enter>:

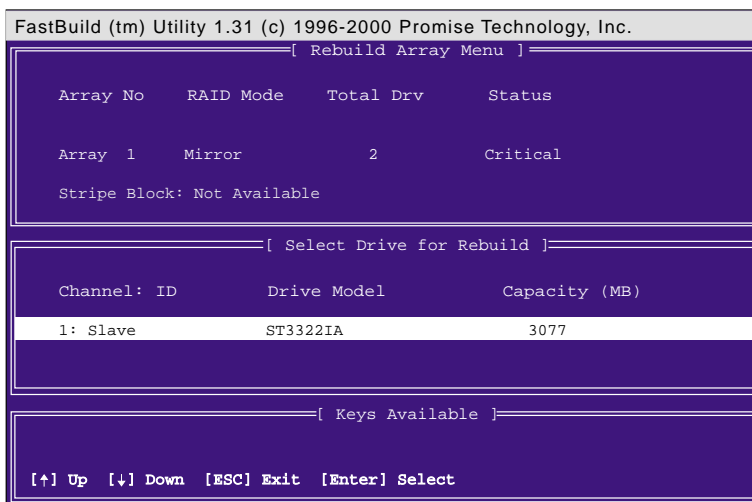

5. SOFTWARE SETUP

8. Confirm the command to copy data from the intact source hard disk onto a new replacement hard disk. A progress gauge displays the copy progress for the duration of the task.
9. After the rebuild is complete, the user is prompted to reboot the system.

Controller Configuration (6): Default for Controller Configuration is: [enabled].

5.4.6 Alternative Set Ups and Other Details

Hot Spares

A hot spare hard disk may be installed to support a RAID 1 array. This spare hard disk must share one of the UltraDMA/100 cables attached to either of the hard disks active in a RAID 1 array. In the event of a failure of either *active* hard disk in the array, the “Lite” BIOS detects the hot spare and automatically rebuilds the mirrored data from the functional hard disk. The FastBuild Utility will report a warning message after such a hard disk failure; it may indicate that the good hard disk and the hot spare are connected to the same cable, so then it will be necessary to transfer the hot spare to the other cable and reboot again.

Use Both ATA-133 Connectors

Optimal performance for RAID 0 and 1 arrays require that each hard disk be connected to separate IDE channels; the first hard disk should be connected to the Primary ATA-133 connector and the second hard disk, to the Secondary ATA-133 connector.

Adding Extra Hard Disks

The A7V266-EX is supplied with two additional Primary IDE and Secondary IDE connectors. Only two hard disks connected to the Primary and Secondary DMA-100 IDE connectors can function in a RAID 0 or RAID 1 array. Extra hard disks may be connected to the system using the onboard IDE connectors, but such disks *cannot* be configured in a RAID array. In principle, up to eight hard disks or other IDE devices may connect to the A7V266-EX. Whether an array is set up or not, all hard disks connected to the A7V266-EX will function at the ATA-133 protocol.

Use DMA-133/100, High-RPM Hard Disks with Identical Storage Capacity

The fastest available hard disks should be used in the RAID 0 array to maximize performance. Slower hard disks may be used; however, the RAID 0 array can only double the speed of particular hard disks. Since you can achieve better performance with a single ATA-133 hard disk than with two ATA-33 disks in a RAID 0 array, it is more effective to install two ATA-133/100/66 high-RPM hard disks for an array. Hard disks used for both RAID 0 and 1 arrays should always have the same storage capacity because the RAID protocol automatically formats both disks to use only up to the maximum write space available on the *smaller* of two different hard disks.

5. SOFTWARE SETUP

5.5 Manual Installation of IDE/RAID Drivers

The A7V266-EX support CD contains several IDE and RAID 0 or 1 drivers in the Promise folder, including Windows, NetWare and Nt4. Below follow two popular OS installations. The others are available on the support CD.

5.5.1 Win9x-ME Promise® MBFastTrak133 Speed BIOS

1. Ensure the Support CD-ROM is in the CD Drive and press “Start” button.
2. Move highlight bar to “Settings” and select “Control Panel”.
3. Double click on “System” icon.
4. Select “Device Manager” page.
5. View device by type and find “Other devices” node.
4. Select the “PCI Mass Storage Controller” node and then click “Properties.”
6. Please select [General] page to reinstall driver or select [Driver] page to update the driver.
7. Follow the instruction to insert your Windows CD or ASUS support CD to install the driver.

(Driver Location: {CD-ROM driver}:\Promise\Raid0or1\Win9x-ME)

5.5.2 Win2000 Promise® MBFastTrak133™ Lite/Simple Controller Driver

1. Right click “My Computer” icon on the desktop. Select “Properties” when the menu appears. Or you can Press “Start” button. Move highlight bar to “Settings” and select: “Control Panel”. Double click on “System” icon.
2. Select “Hardware” page and then click [Device Manager] button.
3. View device by type and find “Other devices” node.
4. Right Click the “Mass Storage Controller” node.
5. When the menu appears, click the “Properties” item.
6. Please select select [Driver] page to update driver.
7. Press Next while “Upgrade Device Driver Wizard” window appears.
8. Choose “Select for a suitable driver for my device(recommended)” option and then press Next.
9. Select “Specify a location” check box.
10. Type or browse the path {CD-ROM Drive}:\Promise\Raid0or1\Win2000 to the driver and click OK.
11. Press Next.
12. Press Yes.
13. Finally, press Finish to complete the installation.
14. Please restart you computer for these changes to take effect.

(Driver Location: {CD-ROM driver}:\Promise\Raid0or1\Win2000)

(This page was intentionally left blank.)

6. SOFTWARE REFERENCE

6.1 Winbond Smart Manager

The *Winbond Smart Manager* is a clever utility that helps secure the PC with a smart card containing a mini-chip insert, like a *GSM cell phone SIM card*. Once a smart card reader is configured, set up the *Smart Manager* software utility for “boot up” or “always on” system security.

6.1.1 Setting Up Smart Manager

Connect the *smart card reader* to the A7V266-EX; (refer to *page 41* in *Hardware Setup* for the *connector* location.) **Boot up** the PC and enter **BIOS** (press) to change the configuration to accept smart card hardware: in the *Advanced BIOS* menu select the *I/O Device Configuration* sub-menu, go to **UART2** and select **Smart Card Read**, save and exit.

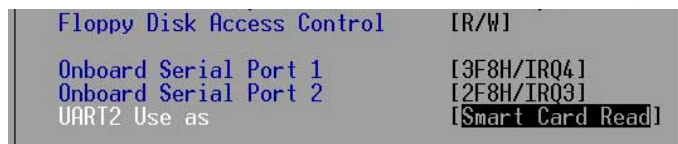

Finish booting up. Insert the ASUS Support CD and click on the selection: **Winbond Smart Manager Application**. The auto-installer prompts to install the *Base Components* and after doing show displays a *readme* file. Next, immediately install the *Smart Card Driver Library* as prompted. Finally, install the *Winbond Smart Manager* application as prompted.

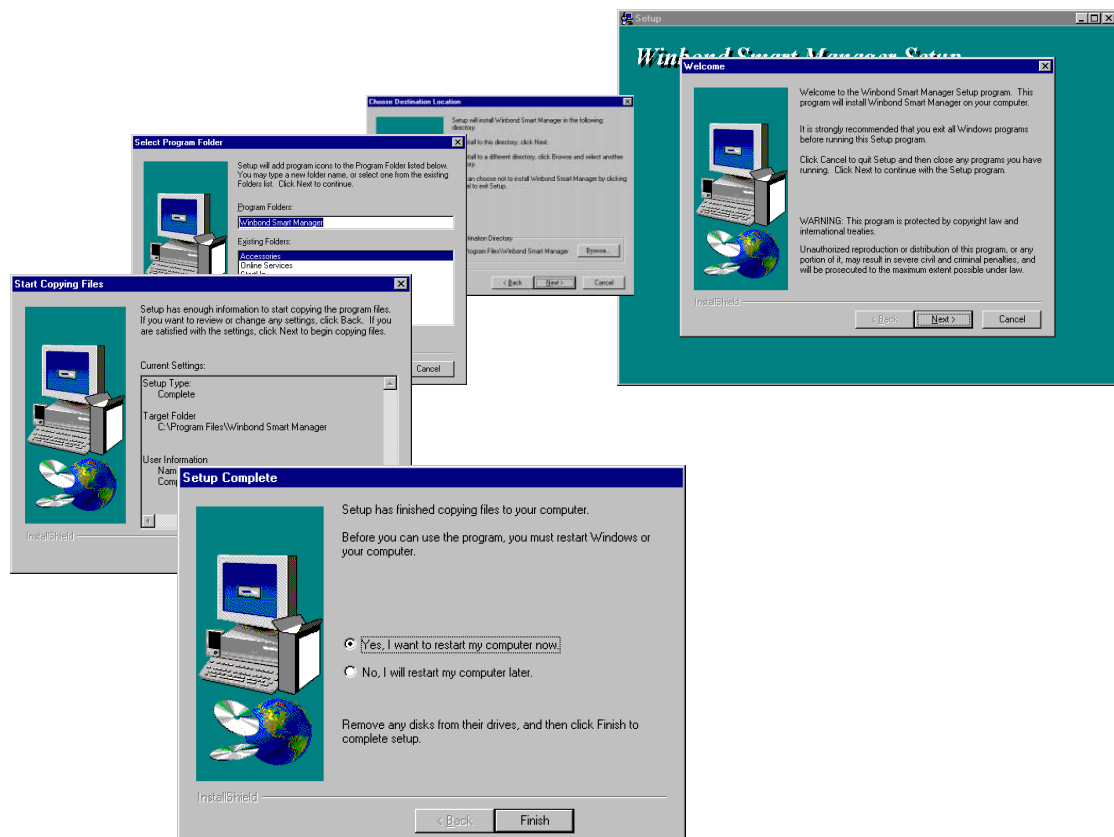

6. SOFTWARE REFERENCE

The auto-installer implements all of the drivers, base components and displays the *Winbond Smart Manager* program groups. **Restart.** *Windows* should auto-detect the *smart card reader* and install its system drivers.



NOTE: Do not install system components or *Winbond* applications *unless* you install a smart card *reader*, (see page 7). Smart card system software components support various types of smart card applications; all system components are compatible with *Windows 98, ME* and *2000*. However, the *Winbond Smart Manager* application is readily compatible *only* with *Windows 98* and *ME*.

6. SOFTWARE REFERENCE

6.1.2 Starting to Use Smart Manager

After installing the software, start *Windbond Smart Manager* for the first time: select the **Programs** menu from the **Start** bar and select the **Windbond** program group. When you click the program application, an **icon** is created for the **Logon Smart Card** software in the bottom right hand corner of the screen.

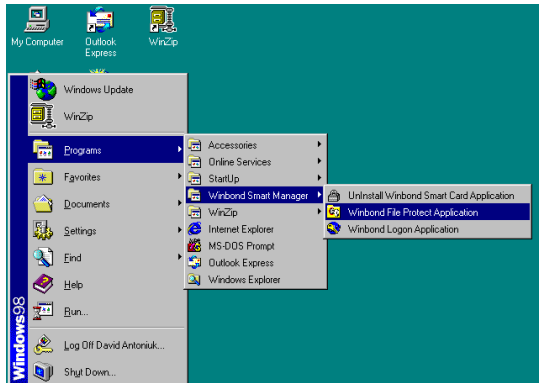

The new **icon** resembles a key.

Right click on the icon and select **Setting Logon Smart Card**.

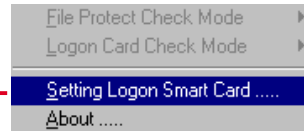

Click the **Add New** button and then select the type of card you are using. Insert the **smart card** into the card reader, then enter your name and any remarks into the fields. Click **OK**.

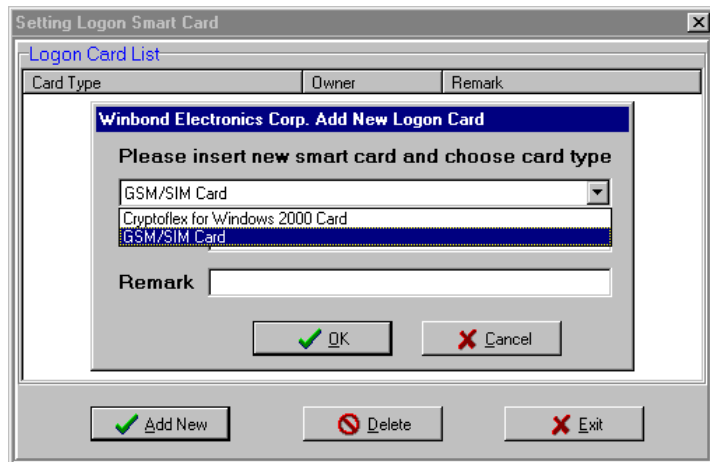

The card reader detects the smart card ID. *Smart Manager* registers the smart card for security capability and prompts to click **OK**. The card's **security status** is displayed in the main program window.

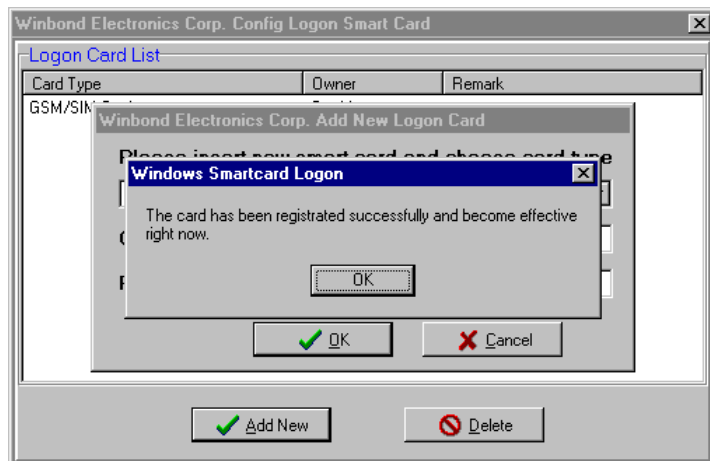

6. SOFTWARE REFERENCE

6.1.3 Smart Manager Modes

Return to the *Windbond Smart Manager* icon on the bottom right hand corner of the *Windows* screen. Select the **Logon Card Check Mode** to choose the security mode. Three basic modes are available:

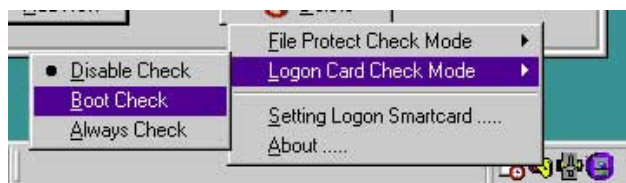

1. **Disable Check** renders the *Smart Manager* security system inoperative.
2. **Boot Check** enables the *Smart Manager* security system for start up. The user must insert the smart card into the reader during start up in order to complete the *Windows* boot up process. In this mode, the user may remove the smart card and continue to use the PC after the start cycle is complete. If no smart card, or the wrong one, is inserted during boot up, the PC displays the *Smart Manager Protection Screen*:

Whenever the *Smart Manager Protection Screen* is displayed, the computer is secured and impenetrable.

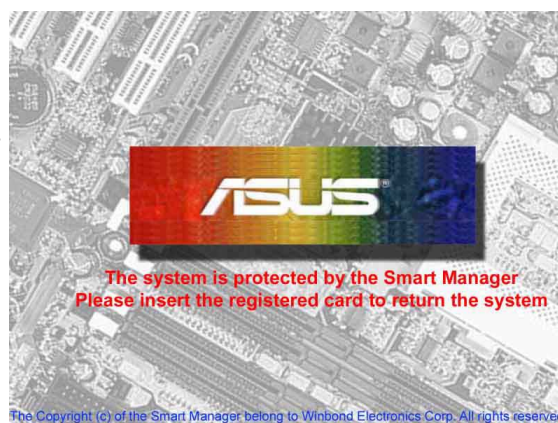

3. **Always Check** configures the *Smart Manager* to require that the user insert the smart card during start up; then, if the card is removed at any time during the operation of the PC, the *Smart Manager* protection screen will automatically pop up and the PC is secure until the card is reinserted.

File Protect Check Mode: This is a sub-program used to encrypt and decode individual files stored in the system using a smart card as a key.

NOTE: Do take care **not to lose** your smart card or you may not be able to restart the PC or decode encrypted files. Test each new smart card to ensure that it is completely compatible with the card reader; the *Read2-In-01 Smart Card Reader* is designed only to read cards with the standard PC/SC mini-chip configuration.

6. SOFTWARE REFERENCE

6.2 ASUS PC Probe

ASUS PC Probe is a convenient utility to continuously monitor your computer system's vital components, such as fan rotations, Voltages, and temperatures. It also has a utility that lets you review useful information about your computer, such as hard disk space, memory usage, and CPU type, CPU speed, and internal/external frequencies through the DMI Explorer.

6.2.1 Starting ASUS PC Probe

When ASUS PC Probe starts, a splash screen appears allowing you to select whether or not to show the screen the next time you open PC Probe. To bypass this startup screen, clear the **Show up in next execution** check box.

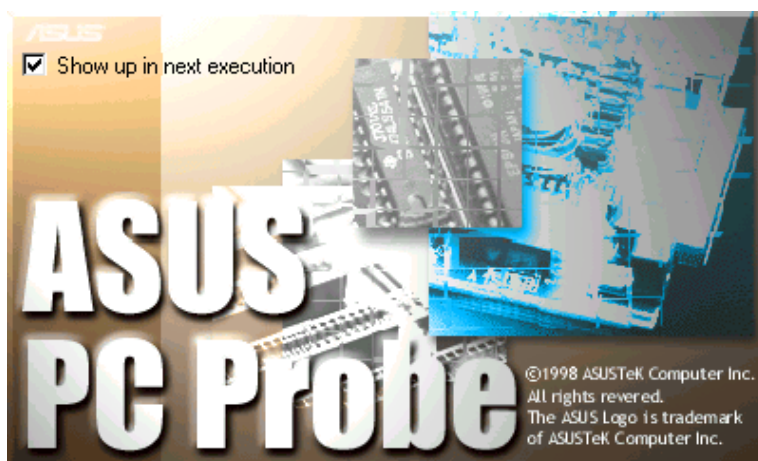

To start **ASUS PC Probe**, click the Windows **Start** button, point to **Programs**, and then **ASUS Utility**, and then click **Probe Vx.xx**.

The PC Probe icon  will appear on the taskbar's system tray indicating that ASUS PC Probe is running. Clicking the icon will allow you to see the status of your PC.

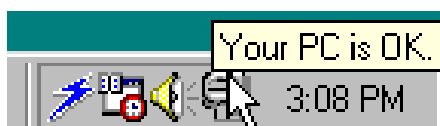

6. SOFTWARE REFERENCE

6.2.2 Using ASUS PC Probe Monitoring

Monitor Summary

Shows a summary of the items being monitored.

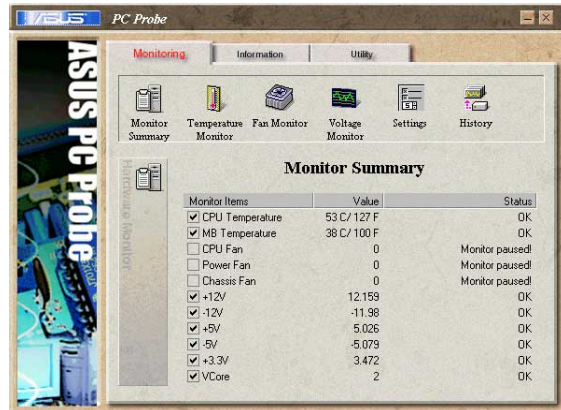

Temperature Monitor

Shows the PC's temperature.

Temperature Warning threshold adjustment
(Move the slider up to increase the threshold level or down to decrease the threshold level)

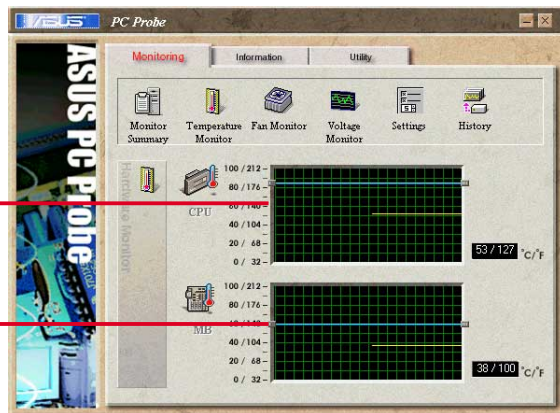

Fan Monitor

Shows the PC's fan rotation.

Fan Warning threshold adjustment
(Move the slider up to increase the threshold level or down to decrease the threshold level)

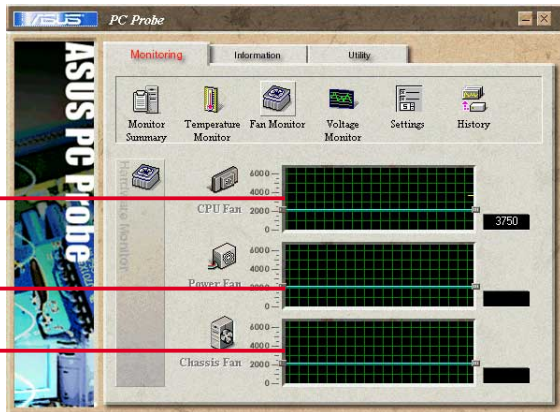

Voltage Monitor

Shows the PC's voltages.

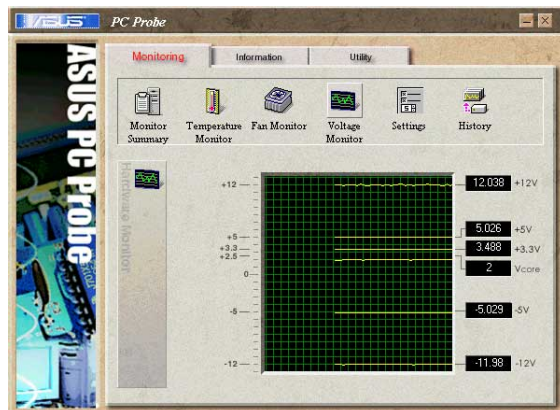

6. SOFTWARE REFERENCE

Settings

Lets you set threshold levels and polling intervals or refresh times of the PC's temperature, fan rotation, and voltages.



CPU Cooling System Setup

Lets you select when to enable software CPU cooling. When **When CPU Overheated** is selected, the CPU cooling system is enabled whenever the CPU temperature reaches the threshold value.

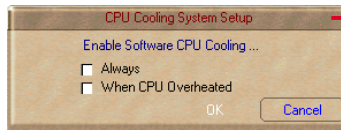

History

Lets you record the current monitoring activity of a certain component of your PC for future reference.

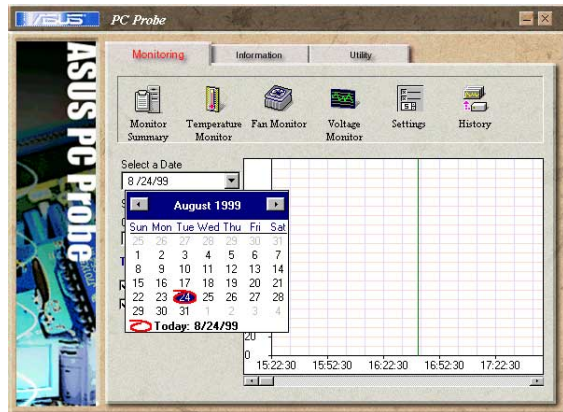

Information

Hard Drives

Shows the used and free space of the PC's hard disk drives and the file allocation table or file system used.



6. SOFTWARE REFERENCE

Memory

Shows the PC's memory load, memory usage, and paging file usage.

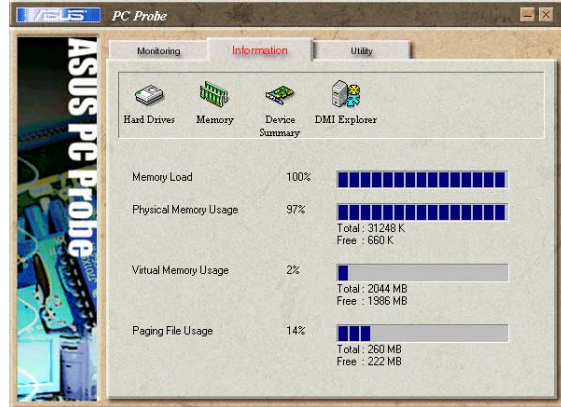

Device Summary

Shows a summary of devices in your PC.



DMI Explorer

Shows information pertinent to the PC, such as CPU type, CPU speed, and internal/external frequencies, and memory size.



Utility

Lets you run programs outside of the ASUS Probe modules. To run a program, click **Execute Program**.



6. SOFTWARE REFERENCE

6.2.3 ASUS PC Probe Task Bar Icon

Right-clicking the PC Probe icon will bring up a menu to open or exit ASUS PC Probe and pause or resume all system monitoring.



When the ASUS PC Probe senses a problem with your PC, portions of the ASUS PC Probe icon changes to red, the PC speaker beeps, and the ASUS PC Probe monitor is displayed.

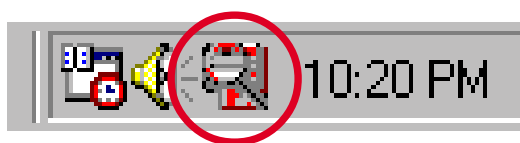

6. SOFTWARE REFERENCE

6.3 Multi-Channel Audio Feature Setup

The C-Media PCI Audio Driver and Applications are located on the Support CD. Installing the programs enables the multi-channel audio feature. **Note:** You must use 4 or 6 channel speakers for this setup.

6.3.1 The C-Media Audio Mixer

1. The C-Media Mixer

Icon appears on the bottom right of the screen, or the **Mixer** may be turned on from the **PCI Audio Applications & Audio Rack** groups on the **Main Program** menu using the Windows **Start** button:  Click on the **icon** to display the C-Media **Audio Mixer**:

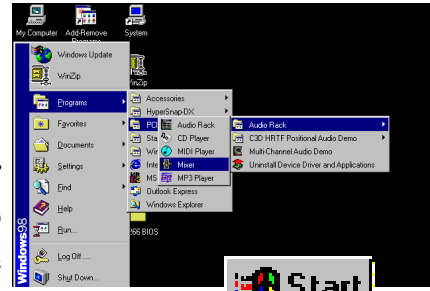

2. The **Advanced** button activates the **Speaker, Volume, Sound Effects** and **Options** menus. The **Speaker** menu offers various configurations for your speaker system. This menu enables the **Line-In** and **Mic-In** audio jacks on the back panel to setup additional speakers for 4 and 6-Channel Audio.

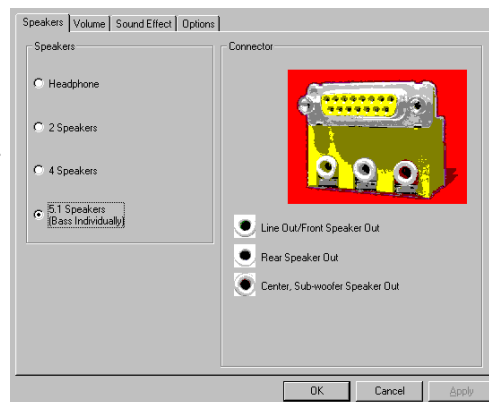

6.3.2 The C-Media Audio Demo Program

1. The Audio Demo program offers an easy way to test and tune your new speaker system. Activate the **Multi-Channel Audio Demo** program from the **PCI Audio Applications** group on the **Main Program** menu using the Windows **Start** button:

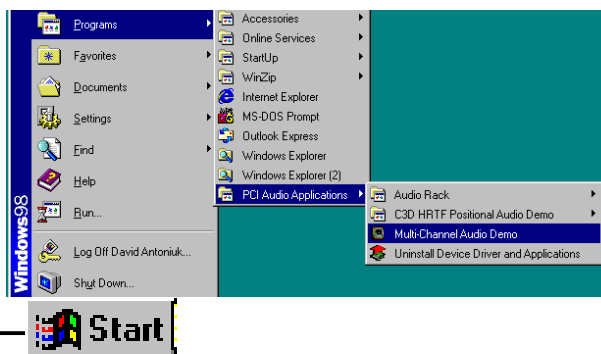

6. SOFTWARE REFERENCE

2. The **PCI Multi-Channel Audio Demo** has several **Demos** to help fine tune your PC speaker system. The **Help** menu features several pages of instructions and hardware diagrams to help configure and test the system. To activate the **Speaker Channel Configuration Menu**, point your mouse arrow and click on the **TV box**.

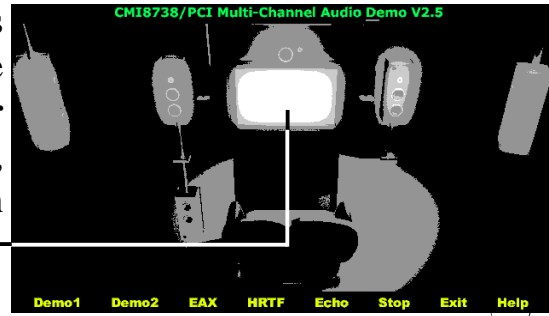

3. The **Speaker Channel Configuration Menu** displays all the options available to help tune the multi-channel audio system even more precisely.

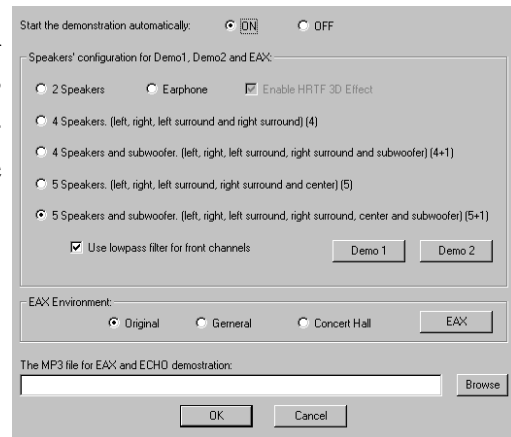

6.3.3 Connector Configuration

The **chart** below displays the configurations for the line connectors on the yellow MIDI/Game/Audio connector port located on the back panel. The three female connectors are available for use in the 6-Channel audio system.

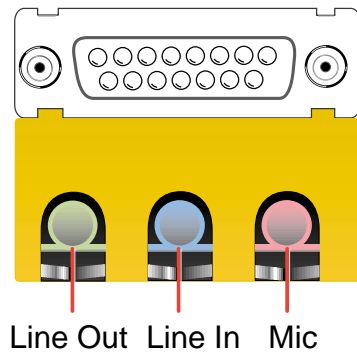

Connector Settings and Functions

	Headphone/ 2-Speaker	4-Speaker	6-Speaker
Lime	Line Out/ Front Spkr Out	Line Out/ Front Spkr Out	Line Out/ Front Spkr Out
Light Blue	Line In	Rear Speaker Out	Rear Speaker Out
Pink	Mic In	Mic In	Center Speaker Out, Sub-woofer

Note: See 7 in Section 3, *Motherboard settings* for the Bass/Center Jumper settings to fine tune the output signals.

6. SOFTWARE REFERENCE

6.4 ASUS Live Update

ASUS LiveUpdate is a utility that allows you to update your motherboard's BIOS and drivers. The use of this utility requires that you are properly connected to the Internet through an Internet Service Provider (ISP).

1. Start ASUS Update

Launch the utility from your Windows Start menu: **Programs/AsusUpdate**

2. Select an update method.

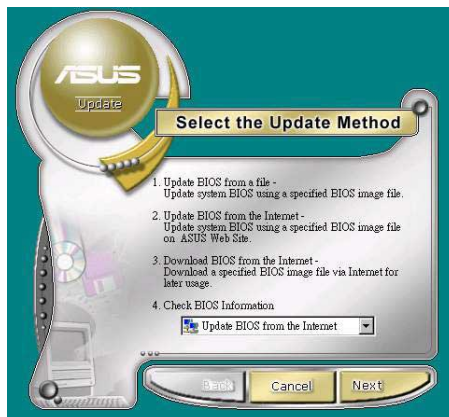

3. If you selected updating/downloading from the Internet, you will need to select an Internet site. Choose the site that is closest to you or click **Auto Select**.

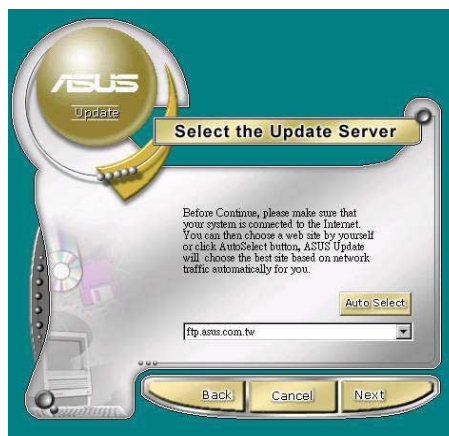

4. From the FTP site, select the BIOS version that you wish to download. Click **Next**.

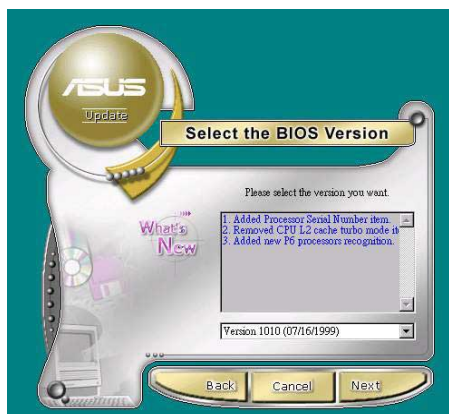

5. Follow the instructions on the succeeding screens to complete the update process. If you selected the option to update the BIOS from a file, a window pops up prompting you to locate the file. Select the file, click **Save**, then follow the screen instructions to complete the update process.

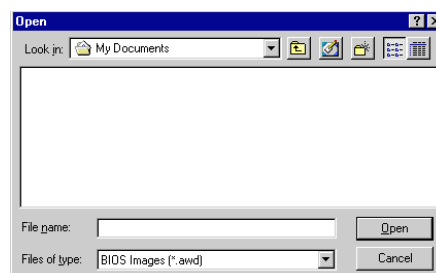

6. SOFTWARE REFERENCE

6.5 3Deep Color Tuner

The 3-Deep color tuner is designed to match your CRT or LCD color monitor to maximize the color quality of all graphical applications. Users may also tune their internet applications to match “true” internet source colors with the color displayed on the monitor.

Simply run the setup program from the start menu and follow the instructions on the various setup/test screens.

6.5.1 3Deep Color Tuning

1. Select the type of monitor connected to the computer, either **CRT** or **LCD**.

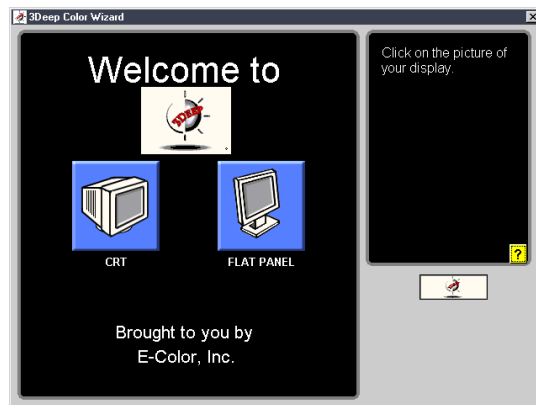

2. Follow the instructions to manually adjust the **brightness** level of the monitor.

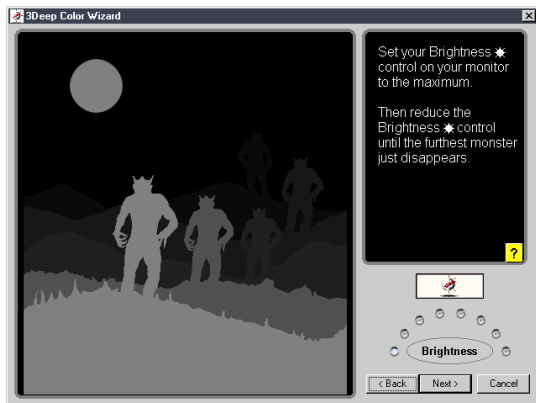

3. Select the faintest of the three colors: **blue**, **red** and **green**.

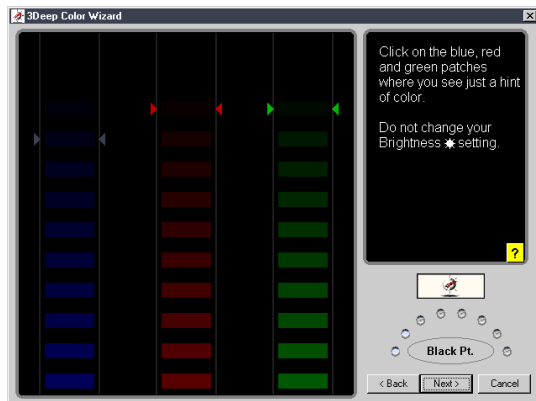

6. SOFTWARE REFERENCE

- 4. Select the color squares which most closely blend and match with the background.
- 5. The next step repeats the color matching process to achieve full color quality.

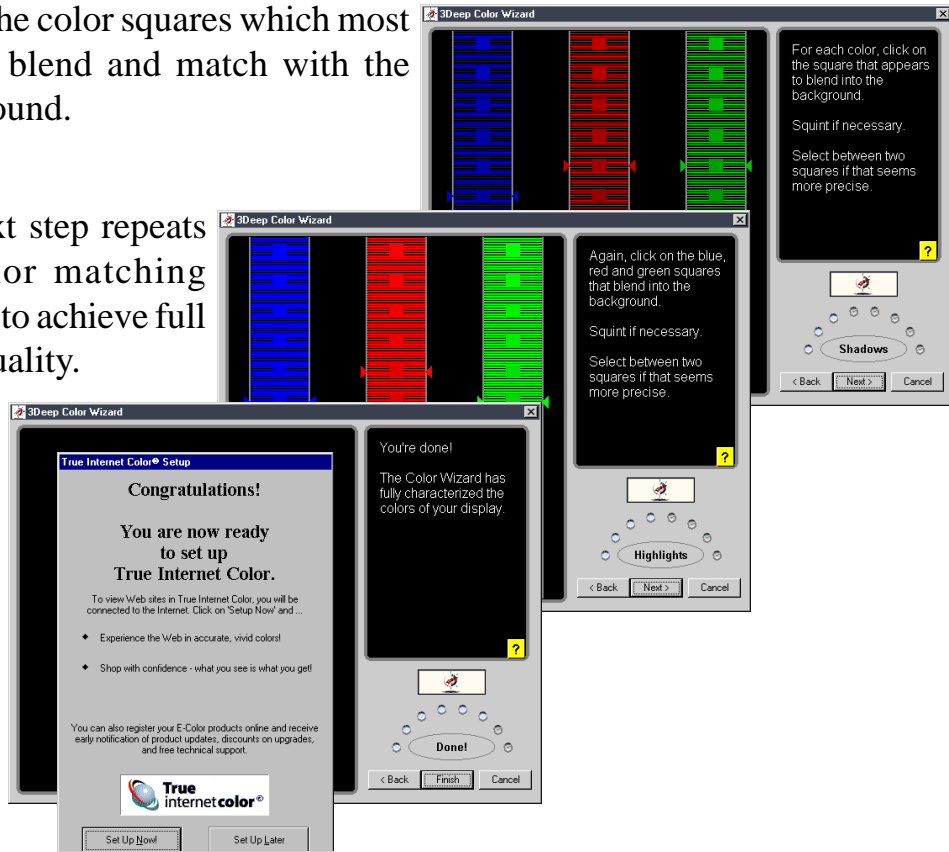

- 6. The tuning process is complete. Click on the bottom left button to connect to the internet and follow the instructions.

6.5.2 The 3Deep Control Panel

Using the Windows **Start** button, activate the **3Deep Control Panel** program from the **3Deep Applications** group on the **Main Program** menu. The control panel offers access to the **Color Wizard** tuning program, a **Game Gamma** setting and a **Tweak** slider for brightness adjustment.

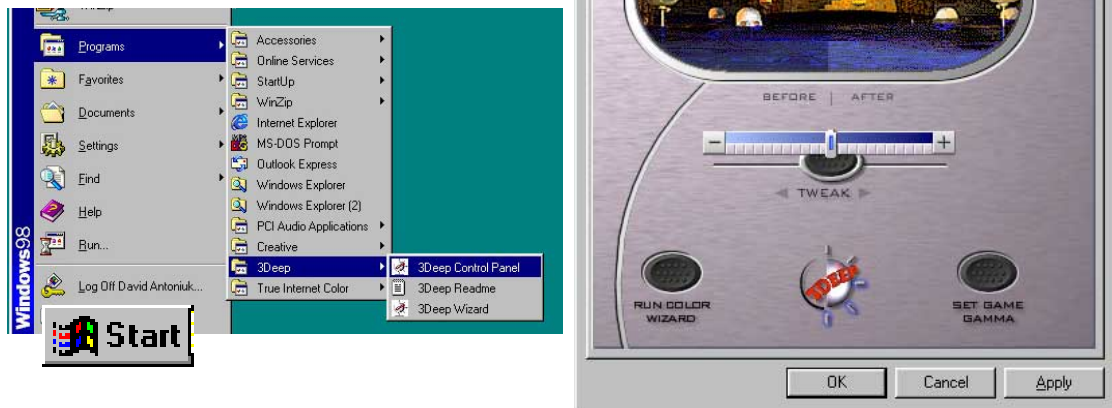

6. SOFTWARE REFERENCE

6.6 CyberLink PowerPlayer SE

CyberLink PowerPlayer SE is an intelligent software player that can automatically detect and playback all kinds of video/audio files, CD and MP3 files as well. This is the only software you need for all types of video and audio files. No need to waste time identifying your file types.

6.6.1 Starting CyberLink PowerPlayer SE

To start **CyberLink Power Player**, click the Windows **Start** button, point to **Programs**, and then **CyberLink PowerPlayer SE**, and then click **PowerPlayer**.

6.6.2 CyberLink PowerPlayer Control Panel

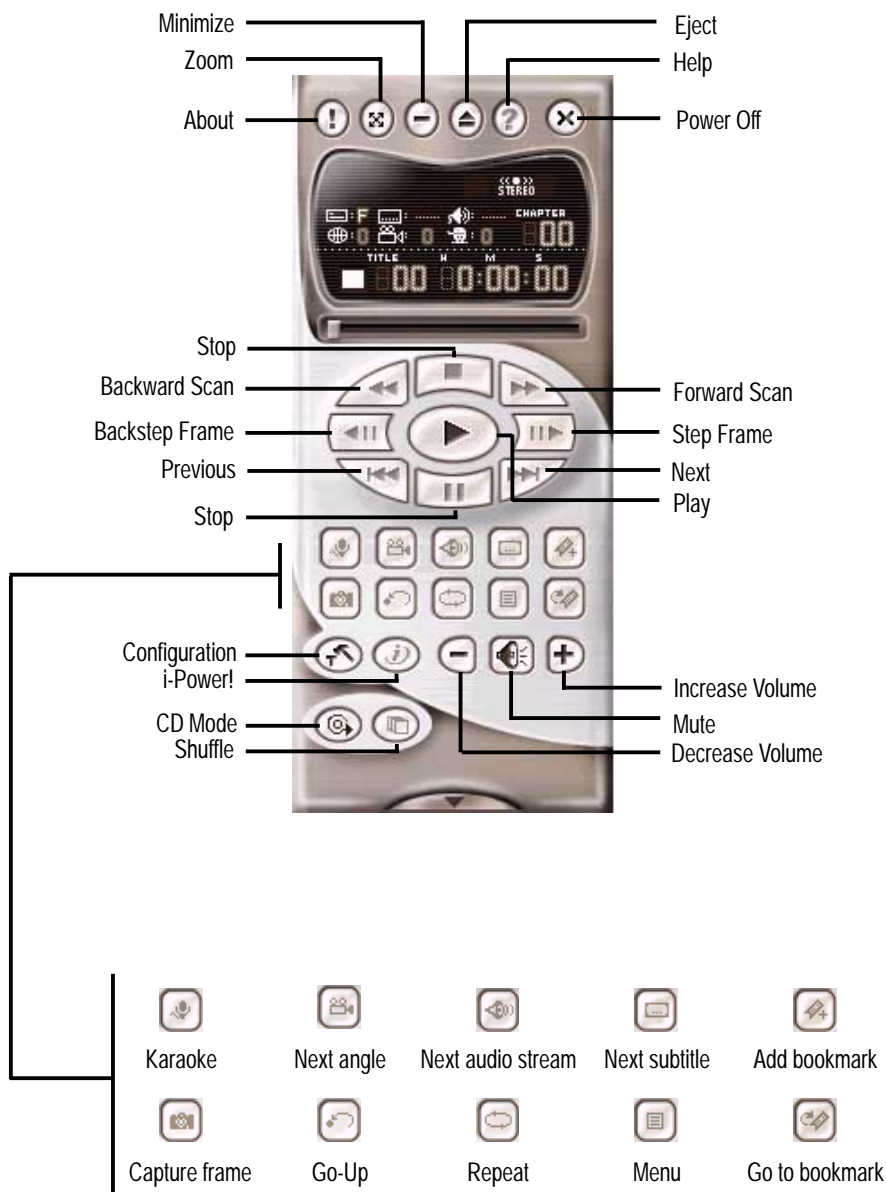

6. SOFTWARE REFERENCE

6.7 CyberLink VideoLive Mail

CyberLink's VideoLive Mail Plus Ver 3.0 (a.k.a. VLM 3) is a convenient and excellent way to create professional quality video mails from PC video/audio input devices and to send the mails to any recipients via VLM 3's built-in e-mail system through the Internet. VLM 3's mails comprise video, sound, or snapshot information; and thus may convey the most profound information to target audiences. It is very convenient for mail recipients who do not need to install additional software component in order to view VLM 3 mails.

VLM 3 works as a very applicant sales tool. It efficiently delivers profound and live product information to your target customers without costing a fortune. VLM 3 also helps corporate managers easily give vivid speeches and broadcast through corporate E-mail system. For personal or home users, VLM 3 easily records live video clips allowing users to send them to friends or family members across the Internet.

VLM 3 loads video messages from PC cameras, digital camcorders, analog camcorder via video capture cards, or from an existing AVI video clips, and captures audio messages from PC microphones. Video and audio messages are encoded at a very high compressed rate in a real-time mode. From data input, data conversion, to sending video mails via Internet, or saving data to disks, the whole procedure is done in an easy and continuous process.

VLM 3's video clip compression rate is up to 1:900, and its playback rate is up to 30 frame per second. VLM 3 provides CIF (352 x 288 pixel) display resolution, and support true color configuration. A one-minute video mail with QCIF (176 x 144) resolution takes up less than 500KB of memory, making it easy to transmit and save mail. Users may always adjust resolution and recording parameters for different purpose.

VLM 3 supports all the hardware devices that are compliant with Video for Windows standard. Video for Windows is a well-accepted and well-tested standard. Thus, users do not have to worry about compatibility issues.

6. SOFTWARE REFERENCE

6.7.1 Starting VideoLive Mail

To start **VideoLive Mail**, click the Windows **Start** button, point to **Programs**, and then **CyberLink VideoLive Mail**, and then click **VideoLive Mail x.x**. VLM 3's Setup Wizard will start and guide you through configuring the video and audio input peripherals and to setup the e-mail environment.

1. Setup Wizard first will prompt a dialog to confirm that you want to configure the hardware and E-mail setting. Click **Yes** to continue the system parameter configuration.
2. The e-mail configuration screen appears. You will need to enter your name and the e-mail address. Click **Next** to continue.
3. The Internet e-mail configuration screen appears. You may choose to use the VLM 3 built-in E-mail functionality (SMTP mail), or use MAPI compliant e-mail system. Consult your ISP or MIS staff for the E-mail server IP address if you are not sure. Click **Next** to continue.
4. Then the Video Configuration screen shows up. You may have to specify the video driver for VLM 3, if there are several video-input devices installed. Then configure the number of video frames to be captured per second. Note that the more frames you choose, the bigger the file size will be. Click **Next** to continue.
5. Then the Setup Wizard will then search for the GSM CODECS module for audio compression, and prompt you with the result. Click **Next** to continue.
6. Setup Wizard then tests the audio volume during playing and recording. Click **Next** when ready.
7. Configuration done. Click **Finish** to complete the environmental setting procedure.

6.7.2 CyberLink VideoLive Mail User Interface



(This page was intentionally left blank.)

7. APPENDIX

7.1 Modem Riser

7.1.1 56K Software Modem

The Modem Riser (MR) is a high-speed PC communication peripheral which works with AMC'97/MC'97 compliant codecs. With this software modem, you can connect your computer to a remote location, receiving data at up to 56 Kbps in V.90 or K56flex modes.

7.1.2 Primary/Secondary MR

There are two types of modem risers: primary MR and secondary MR. In appearance, the primary MR has a crystal onboard but the secondary MR does not. If your motherboard has an audio codec and no PCI audio chipset onboard, you may use the secondary MR; otherwise, you should use the primary MR.

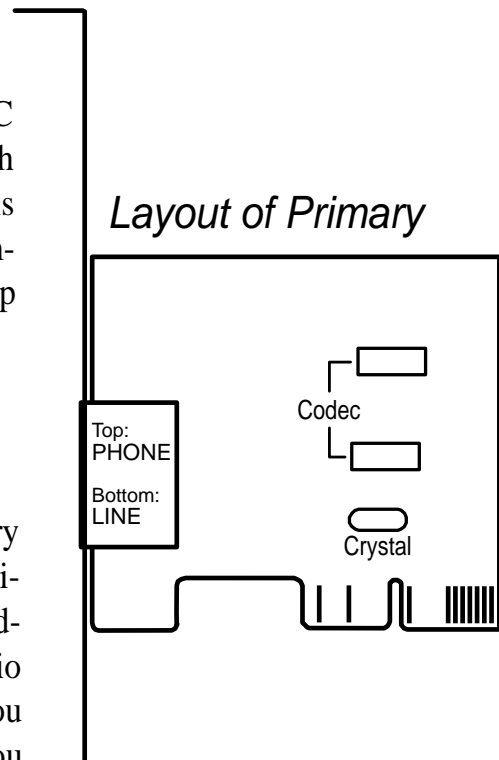

7.1.3 Hardware Installation Procedure

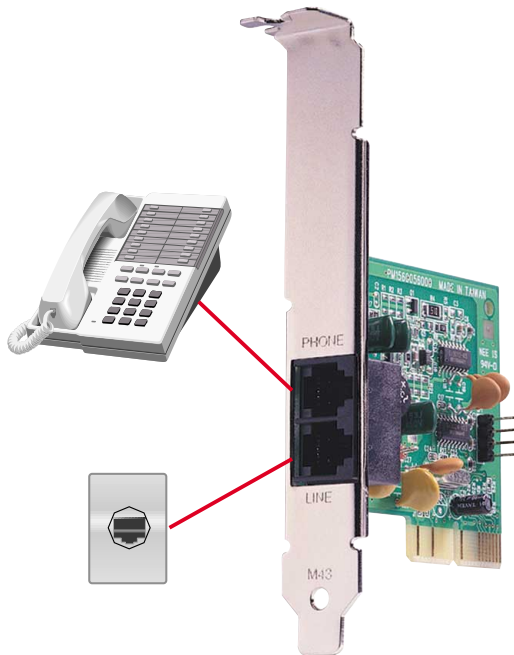

1. Power OFF your computer.
2. Open the computer chassis and remove the metal plate on the AMR expansion slot.
3. Carefully align the MR card's connector to the AMR slot and press firmly.
4. Secure the MR card onto the chassis with the screw removed in step 2.
5. Connect the MR card's **LINE** connector to a telephone wall jack. Connect the **PHONE** connector to a telephone (optional).
6. Replace the computer chassis.

7. APPENDIX

7.1.4 Software Setup in Windows 98

The Modem Riser supports the Plug and Play feature. It allows your computer to automatically set the optimal configurations for the MR and communication software. Follow the procedure below to install the modem driver.

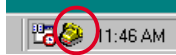
1. Power ON the computer after the hardware installation is completed.
2. Windows 98 will automatically detect the modem and display a “PCI Card” message under “Add New Hardware Found”.
3. Select **Search for the best driver for your device** and click **Next**.
4. Insert the Support CD that came with your motherboard into your CD-ROM drive. Enter the path **E:\Modem\Win98** (assuming that your CD-ROM drive is drive E:) for the MR driver.
5. After the driver is located, click **Next** and then click **Finish**.
6. Restart your computer. Double click the modem icon at the bottom-right corner of the window. 
7. Click the **Settings** tab. Select your country and language. Click **OK**.
8. Click **Start**, point to **Settings**, click **Control Panel**, double click **Modems**, click the **General** tab, and click **Motorola SM56 AC-L Modem**.
9. Click **Diagnostic** and then click the designated COM port as shown.
10. Click **More Info...**. If the computer system successfully communicates with the modem, responses will be displayed as shown.

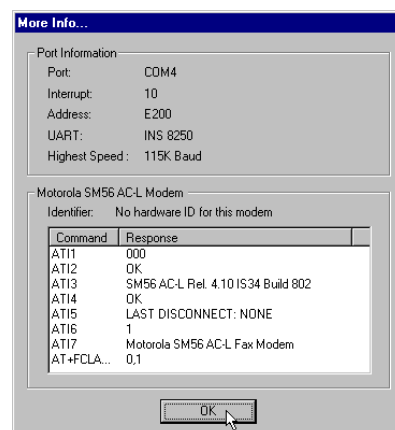
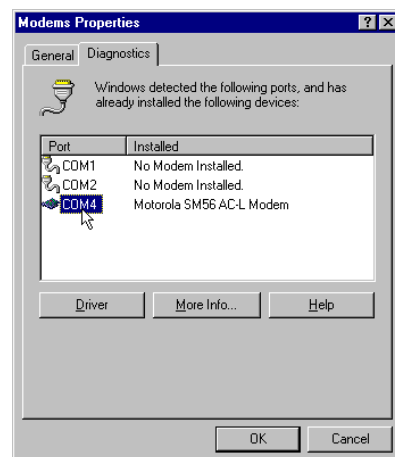

7. APPENDIX

7.2 Glossary

1394

1394 is the IEEE designation for a high performance serial bus that offers data transfers at 100/200/400 Mbps. This serial bus defines both a back plane physical layer and a point-to-point cable-connected virtual bus. The primary application of the cable version is the integration of I/O connectivity at the back panel of personal computers using a low-cost, scalable, high-speed serial interface. The 1394 standard also provides new services such as live connect/disconnect capability for external devices including disk drives, printers and hand-held peripherals such as scanners and cameras. This is a new standard to complement the slower USB interface and to compete with the more expensive SCSI interface.

AC97 (Audio Codec '97)

AC '97 is the next step in enabling PCs with audio quality comparable to consumer electronics devices. The specification defines new cost-effective options to help integrate the components necessary to support next-generation audio-intensive PC applications such as DVD, 3-D multiplayer gaming and interactive music. The specification also defines new extensions supporting modem and docking to help both desktop and mobile manufacturers adopt these new technologies more quickly and cost-effectively. This specification uses software emulation to compete with the PCI SoundBlaster specification.

ACPI (Advanced Configuration and Power Interface)

The ACPI specification defines a cross-platform interface designed to support many operating systems. ACPI defines a flexible and abstract hardware interface that provides a standard way to integrate power management features throughout a PC system, including hardware, operating system and application software. This enables the system to automatically turn ON and OFF peripherals such as CD-ROMs, network cards, hard disk drives, and printers, as well as consumer devices connected to the PC such as VCRs, TVs, phones, and stereos. With this technology, peripherals will also be able to activate the PC. For example, inserting a tape into a VCR can turn on the PC, which could then activate a large-screen TV and high-fidelity sound system.

AGP (Accelerated Graphics Port)

An interface specification that enables high-performance 3D graphics on mainstream PCs. AGP was designed to offer the necessary bandwidth and latency to perform texture mapping directly from system memory.

Bus	Bus Frequency	Bandwidth	Data Transfer Rate
PCI	33MHz	33MHz	133MByte/sec
AGP 1X	66MHz	66MHz	266MByte/sec
AGP 2X	66MHz	133MHz	512MByte/sec
AGP 4X	66MHz	266MHz	1024MByte/sec

Backup. A copy of a file, directory, or volume on a separate storage device from the original. This copy is for the purpose of data retrieval in case the original is accidentally erased, damaged, or destroyed.

BIOS (Basic Input/Output System)

BIOS is a set of routines that affect how the computer transfers data between computer components, such as memory, disks, and the display adapter. The BIOS instructions are built into the computer's read-only memory. BIOS parameters can be configured by the user through the BIOS Setup program. The BIOS can be updated using the provided utility to copy a new BIOS file into the EEPROM.

Bit (Binary Digit)

Represents the smallest unit of data used by the computer. A bit can have one of two values: 0 or 1.

7. APPENDIX

Boot

Boot means to start the computer operating system by loading it into system memory. When the manual instructs you to “boot” your system (or computer), it means to turn ON your computer. “Reboot” means to restart your computer. When using Windows 95 or later, selecting “Restart” from “Start | Shut Down...” will reboot your computer.

Bus Master IDE

PIO (Programmable I/O) IDE requires that the CPU be involved in IDE access and waiting for mechanical events. Bus master IDE transfers data to/from the memory without interrupting the CPU. Bus master IDE driver and bus master IDE hard disk drives are required to support bus master IDE mode.

Byte (Binary Term)

One byte is a group of eight contiguous bits. A byte is used to represent a single alphanumeric character, punctuation mark, or other symbol.

Cache Memory. A type of RAM that allows a faster from the CPU than a regular RAM. The cache memory eliminates the CPU wait state. When the CPU reads data from the main memory, a copy of this data is stored in the cache memory. The next time the same address, the data is transferred from the cache memory instead of from the main memory.

CODEC (Compressor/Decompressor). A software component that translates video or audio between its uncompressed form and the compressed form in which it is stored.

COM Port

COM is a logical device name used by to designate the computer serial ports. Pointing devices, modems, and infrared modules can be connected to COM ports. Each COM port is configured to use a different IRQ and address assignment.

Concurrent PCI

Concurrent PCI maximizes system performance with simultaneous CPU, PCI and ISA bus activities. It includes multi-transaction timing, enhanced write performance, a passive release mechanism and support for PCI 2.1 compliant delayed transactions. Concurrent PCI provides increased bandwidth, reduced system latencies, improves video and audio performance, and improves processing of host based applications.

CPU (Central Processing Unit)

The CPU, sometimes called “Processor,” actually functions as the “brain” of the computer. It interprets and executes program commands and processes data stored in memory. Currently, there are socket 370 (for Pentium III FC-PGA and Celeron-PPGA), socket 7 (for Pentium, AMD, Cyrix, IBM), slot 1 (for Pentium II and III), slot 2 (for Xeon), and slot A (for AMD) processors.

Device Driver

A device driver is a special set of instructions that allows the computer’s operating system to communicate with devices such as VGA, audio, printer, or modem.

DOS (Disk Operating System)

DOS is the foundation on which all other programs and software applications operate, including Windows. DOS is responsible for allocating system resources such as memory, CPU time, disk space, and access to peripheral devices. For this reason, DOS constitutes the basic interface between you and your computer.

DRAM (Dynamic Random Access Memory)

A type of RAM that requires refresh cycles to prevent the loss of the data stored in it. There are several different types of DRAM such as, EDO DRAM (Extended Data Output DRAM), SDRAM (Synchronous DRAM), and RDRAM (Rambus DRAM) and DDR DRAM, (Double-Data Rate DRAM).

Flash ROM

non-volatile memory device that retains its data even when power is removed. This device is similar to EPROM, but unlike EPROM which can be erased only using an ultra-violet light, flash ROM can be electrically erased. Flash ROM is normally used for system BIOS, which initiates hardware devices and sets up necessary parameters for the OS. Since the flash ROM contents can be modified, users can easily update the BIOS..

7. APPENDIX

IDE (Integrated Drive Electronics)

IDE devices integrate the drive control circuitry directly on the drive itself, eliminating the need for a separate adapter card (in the case for SCSI devices). UltraDMA/33 IDE devices can achieve up to 33MB/Sec transfer.

I/O (Input/Output)

The data transfers from the input devices like a keyboard, mouse, or scanner, to the output devices like a printer or the monitor screen.

I/O Address

The specific memory location for a particular device. Two devices cannot share the same I/O address space.

IrDA (Infrared Data Association)

An international organization that creates and promotes inter-operable, low cost, infrared data interconnection standards that support a walk-up, point-to-point model. The IrDA protocol is designed to support transmission of data between two devices over short-range point-to-point infrared at speeds between 9.6Kbps and 4Mbps.

ISP (Internet Service Provider)

A company that provides customer access to the Internet and the World Wide Web for a fee. The ISP also provides Internet utilities and services like e-mail, newsgroup, weather reports, and a host of others. The user can connect to the ISP using a modem installed in the computer and connected to a phone line.

LPT Port (Line Printer Port)

Logical device name reserved by DOS for the computer parallel ports. Each LPT port is configured to use a different IRQ and address assignment.

MMX

A set of 57 new instructions designed to accelerate multimedia and communications applications, such as 3D video, 3D sound, video conference.

Modem

A device that allows a computer to talk to another computer through the phone system.

Network

An interconnected computer system linked by telephone wires, or other means.

OnNow

The OnNow design initiative is a comprehensive, system-wide approach to system and device power control. OnNow is a term for PC that is always ON but appears OFF and responds immediately to user or other requests. The OnNow design initiative involves changes that will occur in the Microsoft Windows operating system, device drivers, hardware, and applications, and also relies on the changes defined in the Advanced Configuration and Power Interface (ACPI) specification.

PC100/133

This is an industry-standard designation for memory capacity as a measure of the speed of the memory bus. New platform requirements ensure that memory does not become a bottleneck to system performance.

PCI Bus (Peripheral Component Interconnect Local Bus)

PCI bus is a standard specification that defines a 32-bit data bus interface.

PCI Bus Master

The PCI Bus Master can perform data transfer without local CPU help and the CPU can be treated as one of the Bus Masters. PCI 2.1 supports concurrent PCI operation to allow the local CPU and bus master to work simultaneously.

POST (Power On Self Test)

Powering on the computer initiates the POST, a series of software-controlled diagnostic tests. The POST checks system memory, the motherboard circuitry, the display, the keyboard, the diskette drive, and other I/O devices

7. APPENDIX

PS/2 Port

PS/2 ports are based on IBM Micro Channel Architecture. This type of architecture transfers data through a 16-bit or 32-bit bus. A PS/2 mouse and/or keyboard may be used on ATX motherboards.

RDRAM (Rambus DRAM)

Developed by Rambus, Inc., this type of memory can deliver up to 1.6GB of data per second. RDRAM is the first interface standard that can be directly implemented on high performance VLSI components such as, CMOS DRAMs, memory controllers, and graphics/video ICs.

RAM (Random Access Memory). The computer's primary storage area used to write, store, and retrieve information and program instructions which are passed to the CPU for processing. The information in RAM can be repeatedly re-written with new data. Compared to other storage media like magnetic tape, floppy disk, and hard disk, RAM has an extraordinarily fast access rate. RAM, however, is volatile, which means that the data stored in it are lost when the system power is turned off, or if power glitches occur. See also DRAM and SDRAM.

ROM (Read Only Memory)

ROM is nonvolatile memory used to store permanent programs (called firmware) used in certain computer components. Flash ROM (or EEPROM) can be reprogrammed with new programs (or BIOS).

SCSI (Small Computer System Interface)

High speed multi-threaded I/O interface defined by the X3T9.2 committee of the American National Standards Institute (ANSI) for connecting many peripheral devices. The standard started from 10MBytes/sec to 160MBytes/sec available today.

SDRAM (Synchronous DRAM)

A type of DRAM with access signals that are synchronized with the CPU clock, eliminating the delay associated with data transfers between the CPU and memory. SDRAM takes memory access away from the CPU control; internal registers in the memory accept the request, and lets the CPU do something else while the data requested is assembled for the next time the CPU talks to the memory.

SPD for SDRAM module

Serial Presence Detect (SPD) is most like an ID detect for SDRAM module, it using a EEPROM component on DIMM module for storing module configuration information inside. The Serial Presence Detect function is implemented using a 2048 bit EEPROM component. This nonvolatile storage device contains data programmed by the DIMM manufacturer that identifies the module type and various SDRAM organization and timing parameters.

System Disk

A system disk contains the core file of an operating system that boots up the operating system.

TCP/IP (Transmission Control Protocol/Internet Protocol). The communications protocol used by the UNIX system and the Internet. TCP checks for lost packets, puts the data from multiple packets into the correct order, and requests that missing or damaged packets be resent.

USB (Universal Serial Bus)

A 4-pin serial cable bus that allows up to 127 plug and play computer peripherals such as keyboard, mouse, joystick, scanner, printer, modem, and monitor to share a bandwidth through a host scheduled token based protocol. This allows attaching or detaching while the host and other peripherals are in operation. Supports synchronous and asynchronous transfer types over the same set of wires up to 12Mbit/sec. USB 2.0 provides twice the transfer rate compared to USB 1.0 and competes with the 1394 standard.

Wake-On-LAN

Computer will automatically wake-up upon receiving a wake-up packet through a Network interface when it is under power soft-off, suspend or sleep mode.

INDEX

Symbols

3Deep Color Tuner
Using 101

A

Accelerated Graphics Port
AGP Capability 61
AGP Pro Slot 30
Accessories
Modem Riser 107
ACR/USB jumpers 22
AGP. *See* Accelerated Graphics Port
ASUS PC Probe
Using 93
ASUS Update
Using 100
ATAPI CD-ROM 72
Automatic Power Up 70

B

Bass center jumper 21
BIOS
Advanced Menu 56
Boot Menu 72
Boot Sequence 72
Exit Menu 74
Language 55
Legend Bar 48
Main Menu 50
Menu Bar 48
Power Menu 67
Setup Defaults, loading 75
Setup Program 47
Smart BIOS 9
Sub-menu launching 49
Updating 43
Boot Device
Selection 72
Boot Up NumLock Status 54
Boot Virus Detection 73

C

C-Media Audio Setup 98
Central Processing Unit 27
Central Processing Unit (CPU)
CPU socket 9
External Frequency 19, 22
Level 1/Level 2 Cache 57
Speed 56
Upgrade/Reinstallation 58
Chassis Intrusion 40
Chip Configuration 60
Clear RTC RAM jumper 24
Connectors
ASUS EZ Plug 9
ATX power 9
Audio 33
Chassis Fan 36
CPU Fan 36
External 31
Floppy disk 9
Floppy Disk Drive 34, 39
Game/MIDI 9, 33
IDE 9, 35
Infrared Module 37
Internal Audio 39
Panel 42
Parallel Port 32
Power Supply Thermal Sensor 39
PS/2 Keyboard 31
PS/2 Mouse 31
Serial Port 32
SMBus 36, 38
USB 32
CPU. *See* Central Processing Unit
CPU external freq. jumper 19
CyberLink
PowerPlayer SE 103
VideoLive Mail 104
CyberLink PowerPlayer SE
Using 103
CyberLink VideoLive Mail
Using 104

INDEX

D

- DIMMs. *See* Dual Inline Memory Modules
- DIP Switches 18

E

- Expansion Cards
 - Assigning IRQs 29
 - Installing 28

F

- Floppy 3 Mode 50
- Floppy Disk Drive Connector 34, 39

G

- Glossary 109

H

- Hard Disk Drives (HDDs)
 - CHS Capacity 53
 - Cylinders 52
 - Heads 53
 - LBA Capacity 53
 - Primary/Secondary Master 51
 - Primary/Secondary Slave 51
 - Sectors 52
 - Translation Method 52
 - Types 51
- Hardware Monitor 71
- Hardware Setup
 - CPU Installation 27
 - Memory Installation 26
 - Procedure 17
- Headers
 - USB 36

I

- IDE Activity LED 34
- IDE Connectors 35
- IDE Hard Disks. *See* Hard Disk Drives

(HDDs)

- Infrared Module Connector 37
- Installation
 - CPU 27
- Interrupt Request (IRQ)
 - Standard Assignments 29

J

- JumperFree Mode
 - Notes for 58
- JumperFree™ Mode 18
- Jumpers
 - ACR/USB jumpers 22
 - Bass center setting 21
 - Clear RTC RAM 24
 - CPU external frequency 19
 - JumperFree mode 18
 - Keyboard wake up 22
 - Promise RAID controller 23
 - Thermal sensor setting 24
 - USB device wake up 23
 - Voltage over setting 20
 - Voltage regulator output 20

K

- Keyboard
 - Auto-Repeat Delay 54
 - Auto-Repeat Rate 54
 - Connector 31
 - Features 54
- Keyboard Lock Switch Lead 16, 42
- Keyboard wake up 22
- Keyboard wake up jumper 22

L

- LAN
 - Jumper Setting 23
- Legacy Diskette 50
- LiveUpdate 101
 - Using 101

INDEX

M

- Memory Hole 62
 - Memory Installation 26
 - Modem Riser 107
 - Motherboard
 - Components 12, 13
 - IRQ Table 29
 - Layout 14
 - Settings 17
 - Specifications 8, 9
 - Mouse
 - Connector 31
 - Multi-Channel Audio 98
 - Using 98
 - Multi-Sector Transfers 53
- ## P
- Parallel Port 63
 - Modes 64
 - Parallel Port Connector 32
 - Password
 - If You Forget 55
 - Notes 55
 - Supervisor 55
 - User 55
 - PC Probe
 - Using 93
 - PCI Configuration 65
 - PCI Latency Timer 65
 - PCI/VGA Palette Snoop 65
 - PIO Mode 53
 - Plug & Play O/S 73
 - Ports. *See* Connectors
 - Power Management 67
 - Power On Self Test 73
 - PowerPlayer SE
 - Using 103
 - Procedure
 - CPU Installation 27
 - Procedures
 - Modem Riser Installation 107

- Promise RAID jumper 23
- PS/2 Keyboard 31
- PS/2 Keyboard Port 9
- PS/2 Mouse 31
 - Function Control 57
- PS/2 Mouse Port 9

R

- RAID 1 or 0 5, 80
- RTC RAM
 - Clearing 24

S

- SCSI BIOS 65
- SDRAM
 - Active to Precharge Time 61
 - CAS Latency 60
 - Configuration 60
 - RAS Precharge Time 60
 - RAS to CAS Delay 60
 - Read Around Write 61
- Serial Ports 63
 - Connectors 32
- Serial ports 9
- Smart Manager 89
 - Modes 92
 - Using 91
- SMART Monitoring 53
- SMBus Connector 36, 38
- Suspend Mode 68
- System Chipset 8
- System Date 50
- System Frequency Multiple 56
- System Hangup 59
- System Time 50
- System/PCI Frequency 56

T

- Thermal Sensor Connector 39
- Thermal sensor CPU jumper 24

INDEX

U

UART2 63

Ultra DMA Mode 53

Universal Serial Bus (USB) 32

 Headers 36

 Ports 32

USB device wake up jumper 23

USB Legacy Support 57

USB ports 9

Using

 3Deep Color Tuner 101

 ASUS Update 100

 LiveUpdate 101

 Multi-Channel Audio Feature 98

 PC Probe 93

 PowerPlayer SE 103

 Windbond Smart Manager 89

USWC 62

V

Video Memory 62

VideoLive Mail 104

 Using 104

Voltage over jumper 20

Voltage regulator output 20

W

Winbond Smart Manager 89

Windbond Smart Manager

 Modes 92

 Using 91