



A7V600-X

User Guide

Motherboard

E1451

First Edition

October 2003

Copyright © 2003 ASUSTeK COMPUTER INC. All Rights Reserved.

No part of this manual, including the products and software described in it, may be reproduced, transmitted, transcribed, stored in a retrieval system, or translated into any language in any form or by any means, except documentation kept by the purchaser for backup purposes, without the express written permission of ASUSTeK COMPUTER INC. ("ASUS").

Product warranty or service will not be extended if: (1) the product is repaired, modified or altered, unless such repair, modification or alteration is authorized in writing by ASUS; or (2) the serial number of the product is defaced or missing.

ASUS PROVIDES THIS MANUAL "AS IS" WITHOUT WARRANTY OF ANY KIND, EITHER EXPRESS OR IMPLIED, INCLUDING BUT NOT LIMITED TO THE IMPLIED WARRANTIES OR CONDITIONS OF MERCHANTABILITY OR FITNESS FOR A PARTICULAR PURPOSE. IN NO EVENT SHALL ASUS, ITS DIRECTORS, OFFICERS, EMPLOYEES OR AGENTS BE LIABLE FOR ANY INDIRECT, SPECIAL, INCIDENTAL, OR CONSEQUENTIAL DAMAGES (INCLUDING DAMAGES FOR LOSS OF PROFITS, LOSS OF BUSINESS, LOSS OF USE OR DATA, INTERRUPTION OF BUSINESS AND THE LIKE), EVEN IF ASUS HAS BEEN ADVISED OF THE POSSIBILITY OF SUCH DAMAGES ARISING FROM ANY DEFECT OR ERROR IN THIS MANUAL OR PRODUCT.

SPECIFICATIONS AND INFORMATION CONTAINED IN THIS MANUAL ARE FURNISHED FOR INFORMATIONAL USE ONLY, AND ARE SUBJECT TO CHANGE AT ANY TIME WITHOUT NOTICE, AND SHOULD NOT BE CONSTRUED AS A COMMITMENT BY ASUS. ASUS ASSUMES NO RESPONSIBILITY OR LIABILITY FOR ANY ERRORS OR INACCURACIES THAT MAY APPEAR IN THIS MANUAL, INCLUDING THE PRODUCTS AND SOFTWARE DESCRIBED IN IT.

Products and corporate names appearing in this manual may or may not be registered trademarks or copyrights of their respective companies, and are used only for identification or explanation and to the owners' benefit, without intent to infringe.

Contents

Notices	v
Safety information	vi
About this guide	vii
ASUS contact information	viii
A7V600-X specifications summary	ix

Chapter 1: Product introduction

1.1 Welcome!	1-2
1.2 Package contents	1-2
1.3 Special Features	1-3
1.3.1 Product highlights	1-3
1.3.2 Value-added solutions	1-5
1.4 Motherboard components	1-6
1.4.1 Core specifications	1-7
1.5 Motherboard layout	1-9
1.6 Before you proceed	1-10
1.7 Motherboard installation	1-11
1.7.1 Placement direction	1-11
1.7.2 Screw holes	1-11
1.8 Central Processing Unit (CPU)	1-12
1.8.1 Installing the CPU	1-12
1.9 System memory	1-13
1.9.1 DDR400 Qualified Vendor List	1-13
1.10 Expansion slots	1-14
1.10.1 Configuring an expansion card	1-14
1.10.2 Standard interrupt assignments	1-14
IRQ assignments for this motherboard	1-15
1.10.3 AGP slot	1-15
1.11 Jumpers	1-16
1.12 Connectors	1-18

Chapter 2: BIOS information

2.1 Managing and updating your BIOS	2-2
2.1.1 Using ASUS EZ Flash to update the BIOS	2-2

Contents

2.1.2	Using AFLASH to update the BIOS	2-4
2.1.3	Recovering the BIOS with CrashFree BIOS 2	2-7
2.2	BIOS Setup program	2-9
2.2.1	BIOS menu bar	2-9
2.2.2	Legend bar	2-10
2.3	Main Menu	2-11
2.3.1	Primary and Secondary Master/Slave	2-13
2.3.2	Keyboard Features	2-15
2.4	Advanced Menu	2-16
2.4.1	Chip Configuration	2-18
2.4.2	I/O Device Configuration	2-20
2.4.3	PCI Configuration	2-22
2.5	Power Menu	2-23
2.5.1	Power Up Control	2-25
2.5.2	Hardware Monitor	2-26
2.6	Boot Menu	2-27
2.7	Exit Menu	2-29

Chapter 3: Software support

3.1	Install an operating system	3-2
3.2	Support CD information	3-2
3.2.1	Running the support CD	3-2
3.2.2	Drivers menu	3-3
3.2.3	Utilities menu	3-3
3.2.4	ASUS Contact Information	3-4
3.3	ASUS Instant Music Lite	3-5
3.4	RAID 0 / RAID 1 / RAID 0 + 1 Configurations	3-7
3.4.1	Install the Serial ATA (SATA) hard disks	3-8
3.4.2	Enter VIA® Tech RAID BIOS Utility	3-9
3.4.3	Create Array	3-10
3.4.4	Delete Array	3-13
3.4.5	Select Boot Array	3-13
3.4.6	Serial Number View	3-14

Notices

Federal Communications Commission Statement

This device complies with Part 15 of the FCC Rules. Operation is subject to the following two conditions:

- This device may not cause harmful interference, and
- This device must accept any interference received including interference that may cause undesired operation.

This equipment has been tested and found to comply with the limits for a Class B digital device, pursuant to Part 15 of the FCC Rules. These limits are designed to provide reasonable protection against harmful interference in a residential installation. This equipment generates, uses and can radiate radio frequency energy and, if not installed and used in accordance with manufacturer's instructions, may cause harmful interference to radio communications. However, there is no guarantee that interference will not occur in a particular installation. If this equipment does cause harmful interference to radio or television reception, which can be determined by turning the equipment off and on, the user is encouraged to try to correct the interference by one or more of the following measures:

- Reorient or relocate the receiving antenna.
- Increase the separation between the equipment and receiver.
- Connect the equipment to an outlet on a circuit different from that to which the receiver is connected.
- Consult the dealer or an experienced radio/TV technician for help.



The use of shielded cables for connection of the monitor to the graphics card is required to assure compliance with FCC regulations. Changes or modifications to this unit not expressly approved by the party responsible for compliance could void the user's authority to operate this equipment.

Canadian Department of Communications Statement

This digital apparatus does not exceed the Class B limits for radio noise emissions from digital apparatus set out in the Radio Interference Regulations of the Canadian Department of Communications.

This class B digital apparatus complies with Canadian ICES-003.

Safety information

Electrical safety

- To prevent electrical shock hazard, disconnect the power cable from the electrical outlet before relocating the system.
- When adding or removing devices to or from the system, ensure that the power cables for the devices are unplugged before the signal cables are connected. If possible, disconnect all power cables from the existing system before you add a device.
- Before connecting or removing signal cables from the motherboard, ensure that all power cables are unplugged.
- Seek professional assistance before using an adapter or extension cord. These devices could interrupt the grounding circuit.
- Make sure that your power supply is set to the correct voltage in your area. If you are not sure about the voltage of the electrical outlet you are using, contact your local power company.
- If the power supply is broken, do not try to fix it by yourself. Contact a qualified service technician or your retailer.

Operation safety

- Before installing the motherboard and adding devices on it, carefully read all the manuals that came with the package.
- Before using the product, make sure all cables are correctly connected and the power cables are not damaged. If you detect any damage, contact your dealer immediately.
- To avoid short circuits, keep paper clips, screws, and staples away from connectors, slots, sockets and circuitry.
- Avoid dust, humidity, and temperature extremes. Do not place the product in any area where it may become wet.
- Place the product on a stable surface.
- If you encounter technical problems with the product, contact a qualified service technician or your retailer.

About this guide

Conventions used in this guide

To make sure that you perform certain tasks properly, take note of the following symbols used throughout this manual.



WARNING/DANGER: Information to prevent injury to yourself when trying to complete a task.



CAUTION: Information to prevent damage to the components when trying to complete a task.



IMPORTANT: Information that you **MUST** follow to complete a task.



NOTE: Tips and additional information to aid in completing a task.

Where to find more information

Refer to the following sources for additional information and for product and software updates.

1. ASUS Websites

The ASUS websites worldwide provide updated information on ASUS hardware and software products. The ASUS websites are listed in the ASUS Contact Information on page viii.

2. Optional Documentation

Your product package may include optional documentation, such as warranty flyers, that may have been added by your dealer. These documents are not part of the standard package.

ASUS contact information

ASUSTeK COMPUTER INC. (Asia-Pacific)

Address: 150 Li-Te Road, Peitou, Taipei, Taiwan 112
General Tel: +886-2-2894-3447
General Fax: +886-2-2894-3449
Web Site: www.asus.com.tw

Technical Support

MB/Others (Tel): +886-2-2890-7121 (English)
Notebook (Tel): +886-2-2890-7122 (English)
Desktop/Server (Tel): +886-2-2890-7123 (English)
Support Fax: +886-2-2890-7698

ASUS COMPUTER INTERNATIONAL (America)

Address: 44370 Nobel Drive, Fremont, CA 94538, USA
General Fax: +1-502-933-8713
General Email: tmd1@asus.com
Web Site: usa.asus.com

Technical Support

Support Fax: +1-502-933-8713
General Support: +1-502-995-0883
Notebook Support: +1-510-739-3777 x5110
Support Email: tsd@asus.com

ASUS COMPUTER GmbH (Germany and Austria)

Address: Harkortstr. 25, 40880 Ratingen, BRD, Germany
General Email: sales@asuscom.de (for marketing requests only)
General Fax: +49-2102-9599-31
Web Site: www.asuscom.de

Technical Support

Components: +49-2102-9599-0
Notebook PC: +49-2102-9599-10
Support Fax: +49-2102-9599-11
Support Email: www.asuscom.de/support (for online support)

ASUSTeK COMPUTER (Middle East and North Africa)

Address: P.O. Box 64133, Dubai, U.A.E.
General Tel: +9714-283-1774
General Fax: +9714-283-1775
Web Site: www.ASUSarabia.com

A7V600-X specifications summary

CPU	Socket A for AMD Athlon XP/Athlon/Duron with Thoroughbred/Barton Core support
Chipset	Northbridge: VIA KT600 Southbridge: VIA VT8237
Front Side Bus (FSB)	400/333/266/200Mhz
Memory	3 x 184-pin DDR DIMM Sockets support a maximum of 3GB unbuffered non-ECC PC3200/2700/2100 DDR SDRAM memory
Expansion slots	1 x AGP 8X 6 x PCI
Storage	2 x UltraDMA 133/100/66 2 x Serial ATA with RAID 0, RAID 1 and JBOD support
Audio	ADI AD1888 6-channel CODEC S/PDIF out interface
LAN	Integrated 10/100 Mbps LAN controller
Special Features	ASUS EZ Flash Power Loss Restart ASUS C.O.P. (CPU Overheating Protection) ASUS CrashFree BIOS 2 ASUS Instant Music Lite
Overclocking Features	ASUS JumperFree ASUS C.P.R. (CPU Parameter Recall) CPU Voltage adjustable SFS (Stepless Frequency Selection) from 100Mhz up to 250MHz at 1MHz increment
Back Panel I/O	1 x Parallel 1 x Serial 1 x PS/2 Keyboard 1 x PS/2 Mouse 1 x Audio I/O 4 x USB 2.0 1 x RJ-45 Port 1 x S/PDIF out port
Internal I/O Connectors	CPU/Chassis FAN connectors 20-pin ATX power connector Chassis Intrusion GAME/MIDI connector CD/AUX audio in Front panel audio connector 2 x USB 2.0 connector supports additional 4 USB 2.0 ports 2 x Serial ATA port

(continued on the next page)

A7V600-X specifications summary

BIOS features	2Mb Flash ROM, ASUS Jumperfree, Award BIOS, PnP, DMI2.0, WfM2.0, SM BIOS2.3, ASUS EZ Flash, ASUS CrashFree BIOS 2, ASUS C.P.R.
Industry standard	PCI 2.2, USB 2.0
Manageability	WfM 2.0. DMI 2.0, WOR, WOL, chassis intrusion
Form Factor	ATX form factor: 12 in x 9.6 in (30.5 cm x 24.5 cm)
Support CD contents	Device drivers ASUS PC Probe Trend Micro™ PC-cillin 2002 anti-virus software (OEM version) ASUS LiveUpdate Utility

* Specifications are subject to change without notice.

Chapter 1

This chapter gives information about the ASUS A7V600-X motherboard that came with the system. This chapter includes the motherboard layout, jumper settings, and connector locations.

Motherboard Info

1.1 Welcome!

Thank you for buying the ASUS® A7V600-X motherboard!

The ASUS A7V600-X motherboard is loaded with the most advanced technologies to deliver the maximum performance for socket A processors. Based on the advanced VIA KT600 chipset with FSB 400 and DDR 400 support, the ASUS A7V600-X also features AGP 8X, Serial ATA, USB 2.0 as well as 6-channel audio, Fast Ethernet LAN and S/PDIF out features. Unique ASUS features such as ASUS C.O.P., C.P.R. , CrashFree BIOS2, and more are included to ensure the best user experience and value in a motherboard.

Before you start installing the motherboard, and hardware devices on it, check the items in your package with the list below.

1.2 Package contents

Check your ASUS A7V600-X package for the following items.

- ✓ ASUS A7V600-X motherboard
ATX form factor: 12 in x 9.6 in (30.5 cm x 24.5 cm)
- ✓ ASUS A7V600-X series support CD
- ✓ 1 pc. 80-conductor ribbon cable for UltraDMA/66/100/133 IDE drives
- ✓ Ribbon cable for a 3.5-inch floppy drive
- ✓ I/O shield
- ✓ Bag of extra jumper caps
- ✓ User Guide

1.3 Special features

1.3.1 Product highlights

400 FSB K7 Platform

The ASUS A7V600-X motherboard is loaded with the most advanced technologies to deliver the maximum performance for socket A processors. Based on the advanced VIA KT600 chipset with FSB 400 and DDR 400 support, the ASUS A7V600-X features AGP8X, Serial ATA, USB 2.0 as well as a 6-channel audio CODEC and Fast Ethernet LAN. Unique ASUS features such as ASUS C.O.P., C.P.R. and more are included to ensure the best user experience and value in a motherboard.

400MHz FSB Athlon XP CPU support

AMD's Athlon XP 3200+ and all follow-up CPUs now support 400MHz Front Side Bus (FSB) for increased office productivity and enhanced digital media experience.

DDR400 (PC3200) support

DDR400 (PC3200), the latest and fastest DDR memory standard, supports bandwidth up to 3.2 GB/s to provide enhanced system performance.

(Note: PC3200 maximum to 2 DIMMs only. Visit the ASUS website for the latest qualified DDR400 module list.)

AGP 8X support

AGP 8X (AGP 3.0) is the next generation VGA interface specification that enables enhanced graphics performance with high bandwidth speeds up to 2.12 GB/s. With a bus of 533Mhz, AGP 8X is twice as fast as AGP 4X.

Serial ATA technology

Serial ATA is the next generation ATA specification that provides scalable performance for today and tomorrow. With up to 150MB/s data transfer rate, SATA is faster than current Parallel ATA, while providing 100% software compatibility.

8 USB 2.0 ports

USB 2.0 is the latest connectivity standard for next generation components and peripherals. USB 2.0 delivers fast transfer speeds up to 40 times faster at 480 MB/s, for easy connectivity and ultra-fast data transfers. The higher bandwidth of USB 2.0 allows connection of devices such as high resolution video conferencing cameras, next generation scanners, printers, and fast storage units. USB 2.0 is backward compatible with USB 1.1.

S/PDIF out port on Back I/O

The A7V600-X provides convenient connectivity to external home theater audio systems via an S/PDIF out interface. Experience 5.1-channel surround sound and enhanced 3D audio while playing your favorite DVDs or games.

C.O.P. (CPU Overheating Protection):

With AMD® Athlon XP™ installed, the motherboard offers automatic CPU Overheating Protection to prolong the life of the entire system. If the CPU temperature exceeds the set criteria, the PC shuts down automatically.

ASUS C.P.R. (CPU Parameter Recall)

The C.P.R. feature of the ASUS motherboard BIOS allows automatic resetting to the BIOS previous settings in case the system hangs due to overclocking. When the system hangs due to overclocking, C.P.R. eliminates the need to open the system chassis and clear the RTC data. Simply reboot the system, and the BIOS automatically restores the previous value of the CPU parameters.

CrashFree BIOS 2

The CrashFree BIOS 2 feature allows you to restore the original BIOS data from the ASUS support CD in case when the BIOS codes and data are corrupted. This protection feature eliminates the need to buy a replacement ROM chip.

ASUS EZ Flash BIOS

With the ASUS EZ Flash, you can easily update the system BIOS even before loading the operating system. No need to use a DOS-based utility or boot from a floppy disk.

ASUS Instant Music Lite

Through this unique feature, the motherboard is conveniently designed to allow users to enjoy their favorite music, without the need to enter Windows. (The stickers on keyboard are separately purchased.)

1.3.2 Value-added solutions

Overclocking

- adjustable CPU frequency multiple in BIOS using the ASUS JumperFree™ solution
- C.P.R. (CPU Parameter Recall)
- adjustable CPU V_{CORE} voltages
- Stepless Frequency Selection (SFS) for fine-tuning system bus frequency from 100MHz up to 250MHz at 1MHz increments

Temperature, fan, and voltage monitoring

The CPU temperature is monitored by the ASUS ASIC to prevent overheating and damage. The system fan rotations per minute (RPM) is monitored for timely failure detection. The system voltage levels are monitored to ensure stable supply of current for critical components.

Chassis intrusion detection

The motherboard supports chassis intrusion monitoring. A chassis intrusion event is retained in CMOS for more protection.

ASUS update

This utility allows you to update the motherboard BIOS through a user-friendly interface. Connect to the Internet then to the ASUS FTP site nearest you to obtain the latest BIOS version for your motherboard.

1.4 Motherboard components

Before you install the motherboard, learn about its major components and available features to facilitate the installation and future upgrades. Refer to the succeeding pages for the component descriptions.

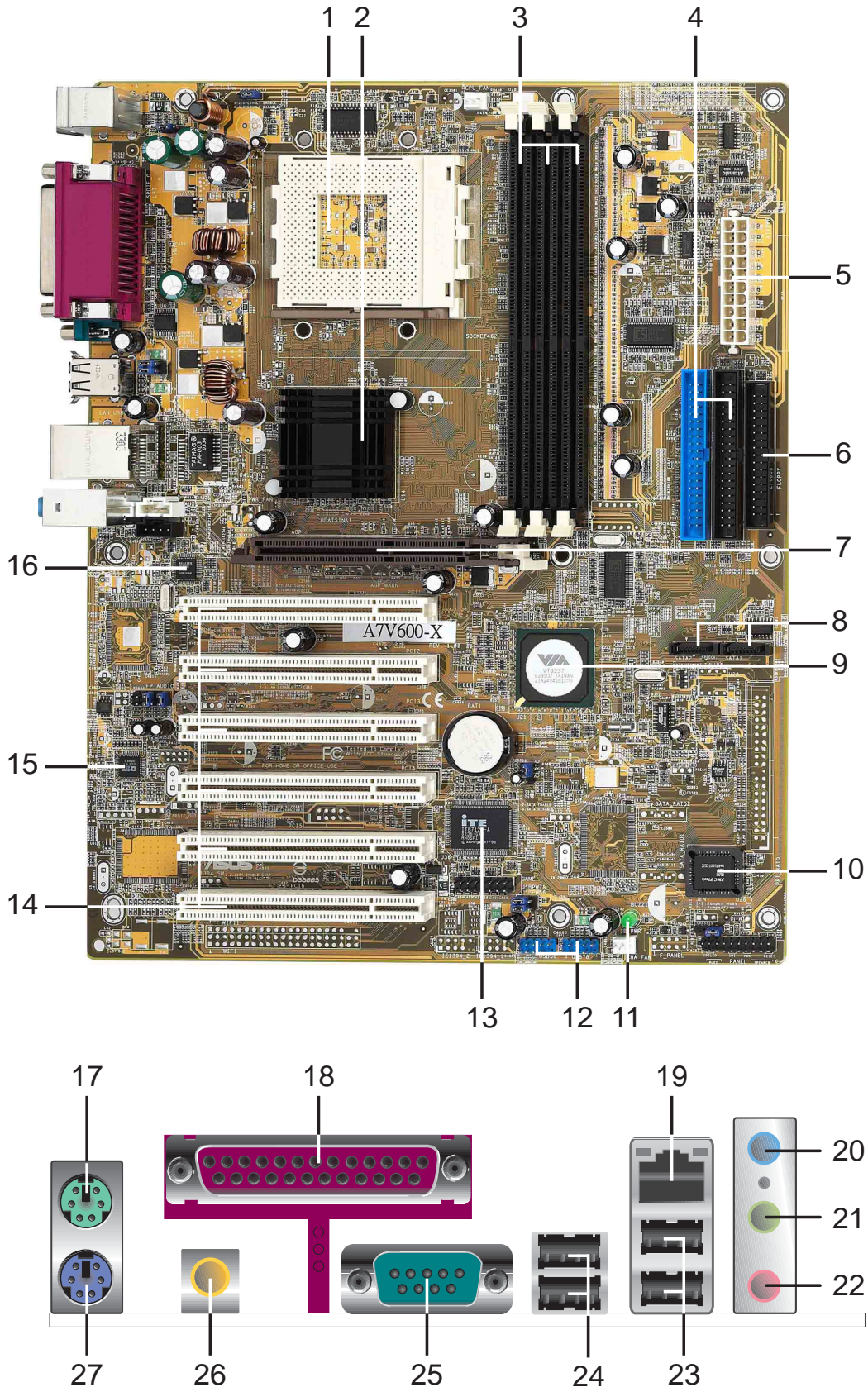

1.4.1 Core specifications

- 1 CPU socket.** Socket 462 (Socket A) surface mount, Zero Insertion Force (ZIF) socket for the AMD Athlon XP/Athlon/Duron Processors.
(Note: *When using CPUs with FSB 100, the maximum DDR data transfer rate allowed is only at 266Mhz.*)
- 2 North bridge controller.** The VIA® **KT600** supports AGP 8X mode, 400/333/266/200MHz Front Side Bus, and the latest 400/333/266MHz 64-bit memory bus.
- 3 DDR DIMM sockets.** These three 184-pin DIMM sockets support up to 3GB system memory using unbuffered non-ECC PC2700/2100 DDR DIMMs.
(Note: *PC3200 maximum to 2 DIMMs support only. Visit the ASUS website (www.asus.com) for the latest qualified DDR400 module list.*)
- 4 IDE connectors.** These dual-channel bus master IDE connectors support up to four Ultra DMA133/100/66, PIO Modes 3 & 4 IDE devices. Both the primary (blue) and secondary (black) connectors are slotted to prevent incorrect insertion of the IDE ribbon cable.
- 5 ATX power connector.** This 20-pin connector connects to an ATX +12V power supply. The power supply must have at least 1A on the +5V standby lead (+5VSB).
- 6 Floppy disk connector.** This connector accommodates the provided ribbon cable for the floppy disk drive. One side of the connector is slotted to prevent incorrect insertion of the floppy disk cable.
- 7 AGP slot.** This Accelerated Graphics Port (AGP) slot supports 1.5V AGP8X mode graphics cards for 3D graphical applications.
- 8 Serial ATA connectors.** These two 7-pin connectors accommodate the thin cables for Serial ATA devices.
- 9 South bridge controller.** The VIA® **VT8237** integrated peripheral controller supports various I/O functions including two Serial ATA ports, 2-channel ATA/133 bus master IDE controller, up to eight USB 2.0 ports, LPC Super I/O interface, AC'97 interface and PCI 2.2 interface.
- 10 Flash ROM.** This 2Mb firmware contains the programmable BIOS program.
- 11 Standby power LED.** This LED lights up if there is a standby power on the motherboard. This LED acts as a reminder to turn off the system power before plugging or unplugging devices.
- 12 USB connectors.** These two 10-1 pin connectors accommodate a USB 2.0 module.
- 13 Super I/O controller.** This Low Pin Count (LPC) interface provides the commonly used Super I/O functionality. The chipset supports a high-performance floppy disk controller for a 360K/720K/1.44M/2.88M floppy disk drive, a multi-mode parallel port, two standard compatible UARTs, and a Flash ROM interface.

- 14** **PCI slots.** These six 32-bit PCI 2.2 expansion slots support bus master PCI cards like SCSI or LAN cards with 133MB/s maximum throughput.
- 15** **Audio CODEC .** The ADI 1888 is an AC'97 compliant audio CODEC for PC multimedia systems.
- 16** **LAN controller.** The Realtek 8201BL Fast Ethernet LAN controller delivers transfer rates of up to 10/100Mbps Ethernet connections. Ideal for handling large amounts of data such as video, audio and voice.
- 17** **PS/2 mouse port.** This green 6-pin connector is for a PS/2 mouse.
- 18** **Parallel port.** This 25-pin port connects a parallel printer, a scanner, or other devices.
- 19** **RJ-45 port.** This port allows connection to a Local Area Network (LAN) through a network hub.
- 20** **Line In jack.** This Line In (light blue) jack connects a tape player or other audio sources. In 6-channel mode, the function of this jack becomes Bass/Center speaker.
- 21** **Line Out jack.** This Line Out (lime) jack connects a headphone or a speaker. In 6-channel mode, the function of this jack becomes Front Speaker Out.
- 22** **Microphone.** This Mic (pink) jack connects a microphone. In a 6-channel mode, the function of this jack becomes Rear Speaker Out.

Audio 2, 4 and 6-channel configuration

Connector	Headphone/2-Speaker	4-Speaker	6-Speaker
Light Blue	Line In	Line In	Bass/Center
Lime	Line Out	Front Speaker Out	Front Speaker Out
Pink	Mic In	Rear Speaker Out	Rear Speaker Out

- 23** **USB 2.0 ports 3 and 4.** These two 4-pin Universal Serial Bus (USB) ports are available for connecting USB 2.0 devices.
- 24** **USB 2.0 ports 1 and 2.** These two 4-pin Universal Serial Bus (USB) ports are available for connecting USB 2.0 devices.
- 25** **Serial port (COM1).** This 9-pin serial port is for an additional serial device.
- 26** **S/PDIF out jack.** This jack connects to external audio output devices.
- 27** **PS/2 keyboard port.** This purple 6-pin connector is for a PS/2 keyboard.

1.5 Motherboard layout

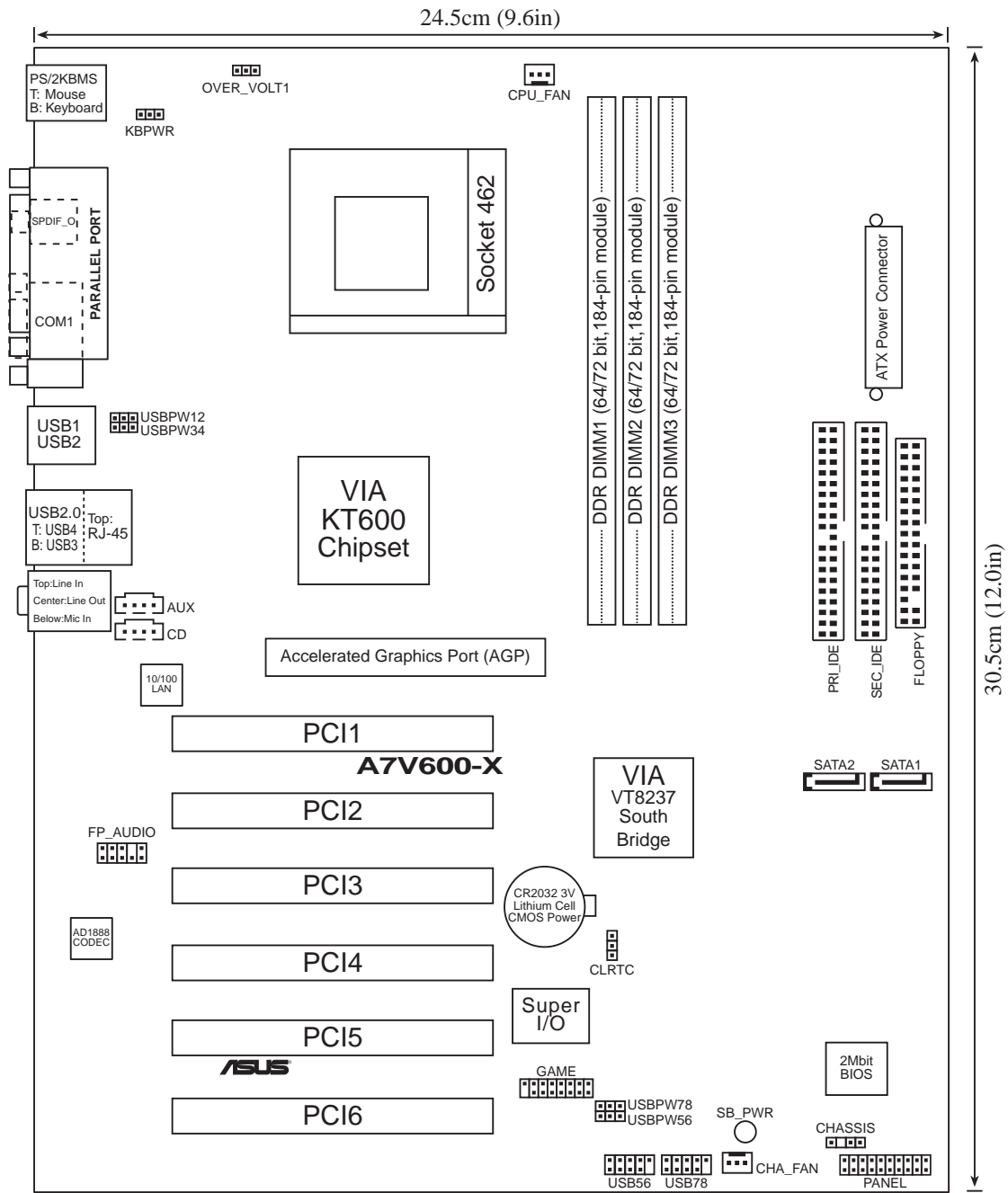

1.6 Before you proceed

Take note of the following precautions before you install motherboard components or change any motherboard settings.



1. Unplug the power cord from the wall socket before touching any component.
2. Use a grounded wrist strap or touch a safely grounded object or to a metal object, such as the power supply case, before handling components to avoid damaging them due to static electricity.
3. Hold components by the edges to avoid touching the ICs on them.
4. Whenever you uninstall any component, place it on a grounded antistatic pad or in the bag that came with the component.
5. **Before you install or remove any component, ensure that the ATX power supply is switched off or the power cord is detached from the power supply.** Failure to do so may cause severe damage to the motherboard, peripherals, and/or components.



When lit, the green LED (SB_PWR) indicates that the system is ON, in sleep mode, or in soft-off mode, a reminder that you should shut down the system and unplug the power cable before removing or plugging in any motherboard component.

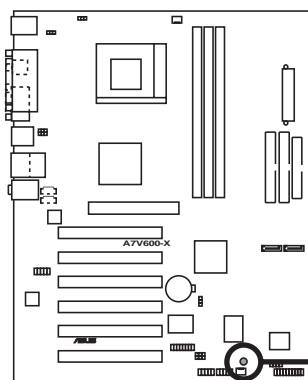

A7V600-X Onboard LED

SB_PWR



ON
Standby
Power



OFF
Powered
Off



Install only 1.5V AGP cards on this motherboard to prevent damage to your AGP card or motherboard.

1.7 Motherboard installation

Before you install the motherboard, study the configuration of your chassis to ensure that the motherboard fits into it. The motherboard uses the ATX form factor that measures 12 inches x 9.6 inches (30.5 cm x 24.5 cm).



Make sure to unplug the power cord before installing or removing the motherboard. Failure to do so may cause you physical injury and damage motherboard components.

1.7.1 Placement direction

When installing the motherboard, make sure that you place it into the chassis in the correct orientation. The edge with external ports goes to the rear part of the chassis as indicated in the image below.

1.7.2 Screw holes

Place nine (9) screws into the holes indicated by circles to secure the motherboard to the chassis.



Do not overtighten the screws! Doing so may damage the motherboard.

Place this side towards
the rear of the chassis

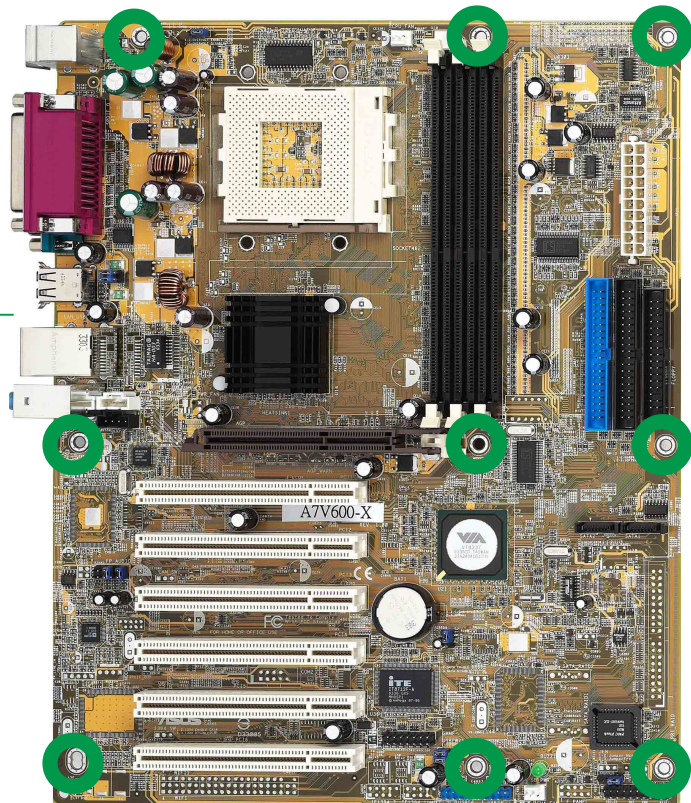

1.8 Central Processing Unit (CPU)

The motherboard provides a Socket A (462) for CPU installation. AMD processors offer gigahertz speeds to support all the latest computing platforms and applications. The A7V600-X supports Athlon™ XP, AMD Athlon™, AMD Barton™ and AMD Duron™ processors.

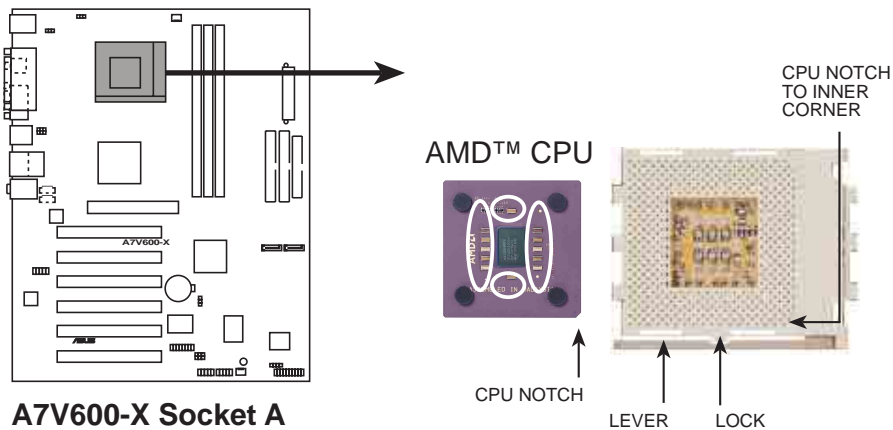

1.8.1 Installing the CPU

Follow these steps to install a CPU:

1. Locate the Socket 462 and open it by pulling the lever gently sideways away from the socket. Then lift the lever upwards. The socket lever must be fully opened (90 to 100 degrees).
2. Insert the CPU with the correct orientation. The **notched or golden corner** of the CPU must be oriented toward the inner corner of the socket base nearest to the lever hinge.

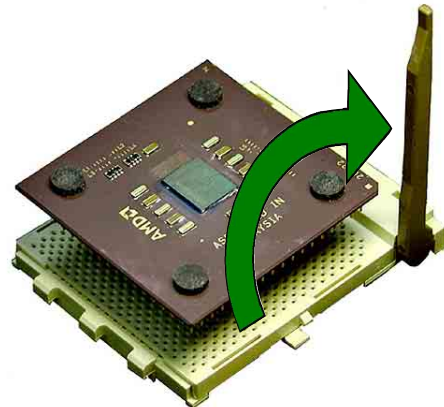

The CPU should drop easily into place. **Do not force the CPU** into the socket to avoid bending the pins. If the CPU does not fit, check its alignment and look for bent pins.

4. Once completely inserted, press the CPU firmly and close the socket lever until it snaps shut.
5. Place the CPU fan and heatsink on the CPU. The heatsink should entirely cover the CPU. Carefully attach the heatsink locking brace to the plastic clips on the socket base. With the added weight of the CPU fan and heatsink locking brace, no extra force is required to keep the CPU in place

1.9 System memory

The motherboard has three Double Data Rate (DDR) DIMM sockets that supports up to 3GB unbuffered non-ECC PC3200/2700/2100 DDR DIMMs.

A DDR DIMM has the same physical dimensions as an SDR DIMM, but it has a 184-pin footprint compared to the 168-pin of the SDR DIMM. Also, a DDR DIMM is single notched while an SDR DIMM is double notched.

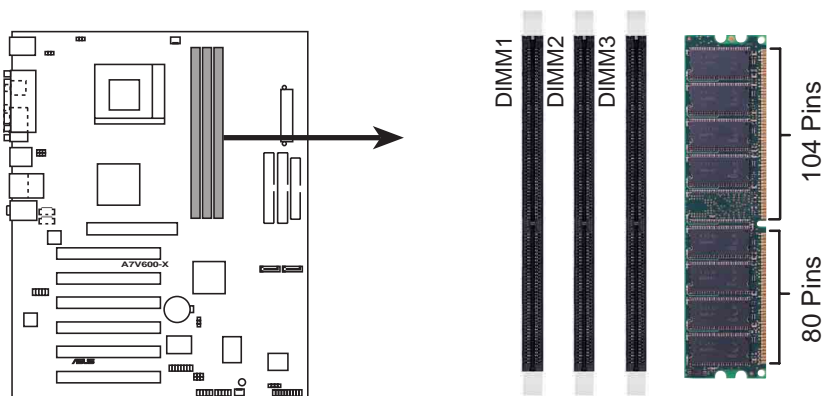

A7V600-X 184-Pin DDR DIMM Sockets



A DDR DIMM is keyed with a notch so that it fits in only one direction. DO NOT force a DIMM into a socket to avoid damaging the DIMM.



PC3200 maximum to 2 banks only.

1.9.1 DDR400 Qualified Vendor List

The following table lists the PC3200-DDR400 memory modules that have been tested and qualified for use with this motherboard. Make sure to use only the tested and qualified DDR400 DIMMs listed below.

1.9.1.1 DDR400 One DIMM support only

Vendor	Size	Type	P/N	Chip
Samsung	512MB	DS	M368L6432ETM-CCC	K4H560838E-TCCC
KingMax	512MB	DS	MPXC22D-38KT3R	KDL388P4EA-50
Micron	256MB	SS	MT8VDDT3264AG-40BC4	MT46V32MTG-5BC
Micron	512MB	DS	MT16VDDT6464AG-40BC4	MT46V32M8TG-5BC
NANYA	512MB	DS	NT512D64S8B1G-5T	NT5DS32M8BT-5T
Infineon	512MB	DS	HYS64D64320GU-5-B	HYB25D256800BT-5

1.9.1.2 DDR400 Two DIMM support only

Vendor	Size	Type	P/N	Chip
GEIL	512MB	DS	MAG16UL3264D1TG5A-KC	GL3LC32G88TG-5A
Micron	512MB	DS	MT16VDDT6464AG-40BC4	MT46V32M8TG-5BC
Nanya	256MB	SS	NT256D64S88B1G-5T	NT5DS32M8BT-5T
ADATA	256	SS	MDOSS6F3G31JB1EAE	K4H560838D-TCC4

1.10 Expansion slots

The A7V600-X motherboard has six (6) expansion PCI slots and one (1) AGP 8X slot. The following sub-sections describe the slots and the expansion cards that they support.

1.10.1 Configuring an expansion card

After physically installing the expansion card, configure the card by adjusting the software settings.

1. Turn on the system and change the necessary BIOS settings, if any.
2. Assign an IRQ to the card. Refer to the tables below.
3. Install the software drivers for the expansion card.

1.10.2 Standard Interrupt Assignments

IRQ	Priority	Standard Function
0	1	System Timer
1	2	Keyboard Controller
2	N/A	Programmable Interrupt
4*	12	Communications Port (COM1)
5*	13	Sound Card (sometimes LPT2)
6	14	Floppy Disk Controller
7*	15	Printer Port (LPT1)
8	3	System CMOS/Real Time Clock
9*	4	ACPI Mode when used
10*	5	IRQ Holder for PCI Steering
11*	6	IRQ Holder for PCI Steering
12*	7	PS/2 Compatible Mouse Port
13	8	Numeric Data Processor
14*	9	Primary IDE Channel
15*	10	Secondary IDE Channel

*These IRQs are usually available for ISA or PCI devices.

IRQ assignments for this motherboard

	A	B	C	D	E	F	G	H
PCI slot	—	—	—	shared	—	—	—	—
PCI slot 2	shared	—	—	—	—	—	—	—
PCI slot 3	—	shared	—	—	—	—	—	—
PCI slot 4	—	—	shared	—	—	—	—	—
PCI slot 5	—	—	—	shared	—	—	—	—
PCI slot 6	shared	—	—	—	—	—	—	—
AGP slot	shared	—	—	—	—	—	—	—
USB 1.1 UHCI 1	—	—	—	—	shared	—	—	—
USB 1.1 UHCI 2	—	—	—	—	shared	—	—	—
USB 1.1 UHCI 3	—	—	—	—	—	shared	—	—
USB 1.1 UHCI 4	—	—	—	—	—	shared	—	—
USB 2.0 EHCI	—	—	—	—	—	—	shared	—
USB Device	—	—	—	—	—	—	—	shared
AC97 Codec	—	—	—	—	—	—	shared	—
Onboard LAN	—	—	shared	—	—	—	—	—
Onboard SATA	—	—	—	—	shared	—	—	—
Onboard IDE	—	—	—	—	shared	—	—	—

1.10.3 AGP slot

This motherboard has an Accelerated Graphics Port (AGP) slot that supports +1.5V AGP cards only. When you buy an AGP card, make sure that you ask for one with +1.5V specification. Note the notches on the card golden fingers to ensure that they fit the AGP slot on your motherboard.

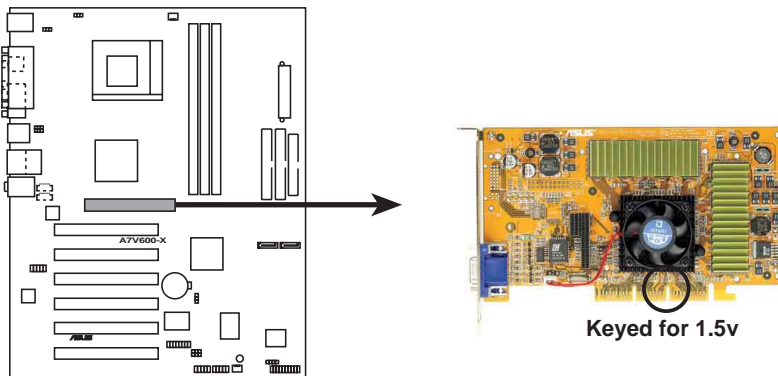

A7V600-X Accelerated Graphics Port (AGP)

1.11 Jumpers

1. USB device wake-up (3-pin USBPW12, USBPW34, USBPW56, USBPW78)

Set these jumpers to +5V to wake up the computer from S1 sleep mode (CPU stopped, DRAM refreshed, system running in low power mode) using the connected USB devices. Set to +5VSB to wake up from S3 sleep mode (no power to CPU, DRAM in slow refresh, power supply in reduced power mode). All jumpers are set to pins 1-2 (+5V) by default because not all computers have the appropriate power supply to support this feature.

The USBPW12 and USBPW34 jumpers are for the rear USB ports. The USBPW56 and USBPW78 jumpers are for the internal USB header that you can connect to the front USB ports.

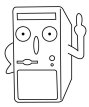

1. This feature requires a power supply that can provide at least 2A on the +5VSB lead when these jumpers are set to +5VSB. Otherwise, the system does not power up.
2. The total current consumed must NOT exceed the power supply capability (+5VSB) whether under normal or in sleep mode.

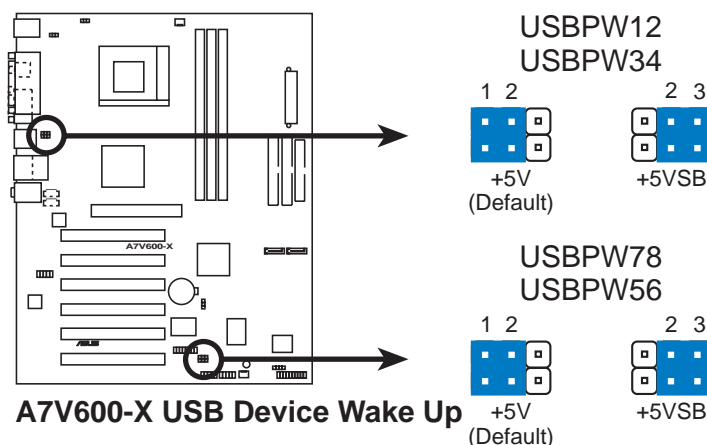

2. Keyboard power (3-pin KBPWR)

This jumper allows you to enable or disable the keyboard wake-up feature. Set this jumper to pins 2-3 (+5VSB) if you wish to wake up the computer when you press a key on the keyboard (the default value is [Disabled]). This feature requires an ATX power supply that can supply at least 1A on the +5VSB lead, and a corresponding setting in the BIOS (see section 4.5.1 Power Up Control).

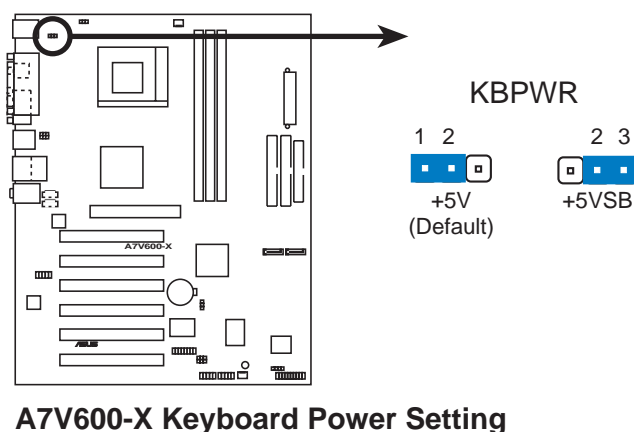

3. Clear RTC RAM (CLRTC)

These jumpers allow you to clear the Real Time Clock (RTC) RAM in CMOS. You can clear the CMOS memory of date, time, and system setup parameters by erasing the CMOS RTC RAM data. The RAM data in CMOS is powered by the onboard button cell battery.

To erase the RTC RAM:

1. Turn OFF the computer and unplug the power cord.
2. Remove the battery.
3. Move the jumper cap to pin [1-2] to clear CMOS then replace the jumper cap back to pin [2-3] after 3 seconds.
4. Re-install the battery.
5. Plug the power cord and turn ON the computer.
6. Hold down the key during the boot process and enter BIOS setup to re-enter data.

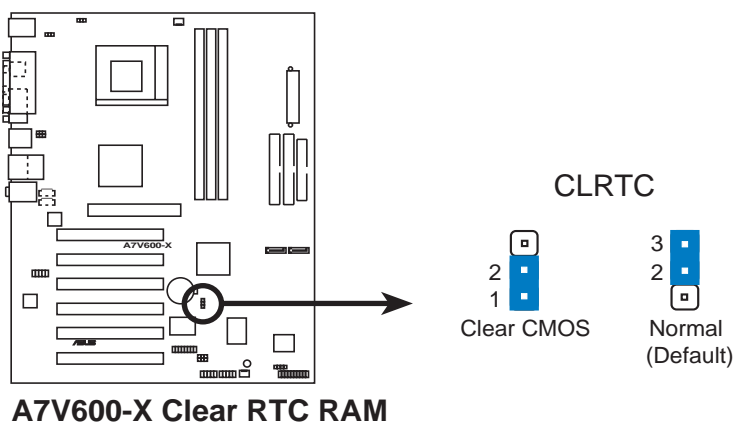

4. V_{CORE} over-voltage (3-pin OVER_VOLT1)

When enabled, this jumper allows CPU V_{CORE} ranges of 1.7V to 2.05V.

When this jumper is disabled, V_{CORE} setting has a range of +1.5V to +1.85V. You may adjust the CPU V_{CORE} through the BIOS Setup.



Setting to a very high core voltage may cause permanent damage to the CPU. It is recommended that you keep the default setting (Disable).

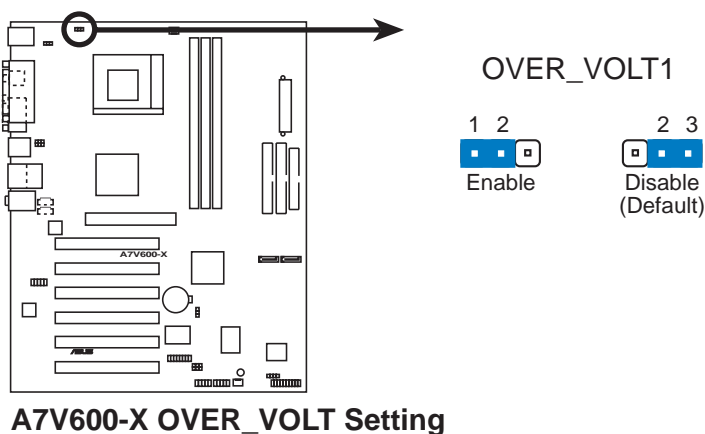

1.12 Connectors

This section describes and illustrates the connectors on the motherboard.

1. IDE connectors (40-pin PRI_IDE, SEC_IDE)

This connector supports the provided UltraDMA/133/100/66 IDE hard disk ribbon cable. Connect the cable's blue connector to the primary (recommended) or secondary IDE connector, then connect the gray connector to the UltraDMA/133/100/66 slave device (hard disk drive) and the black connector to the UltraDMA/133/100/66 master device. It is recommended that you connect non-UltraDMA/133/100/66 devices to the secondary IDE connector. If you install two hard disks, you must configure the second drive as a slave device by setting its jumper accordingly. Refer to the hard disk documentation for the jumper settings. BIOS supports specific device bootup. If you have more than two UltraDMA/133/100/66 devices, purchase another UltraDMA/133/100/66 cable. You may configure two hard disks to be both master devices with two ribbon cables – one for the primary IDE connector and another for the secondary IDE connector.



1. Pin 20 on each IDE connector is removed to match the covered hole on the UltraDMA cable connector. This prevents incorrect orientation when you connect the cables.
2. The hole near the blue connector on the UltraDMA/133/100/66 cable is intentional.

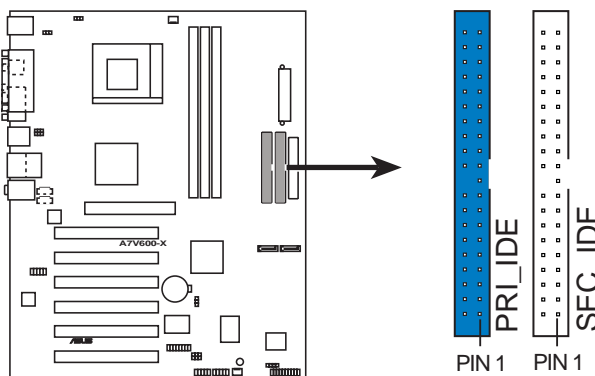

NOTE: Orient the red markings (usually zigzag) on the IDE ribbon cable to PIN 1.

A7V600-X IDE Connectors



For UltraDMA/133/100/66 IDE devices, use an 80-conductor IDE cable. The UltraDMA/66 cable included in the motherboard package also supports UltraDMA/133/100.

2. Floppy disk drive connector (34-1 pin FLOPPY)

This connector supports the provided floppy drive ribbon cable. After connecting one end to the motherboard, connect the other end to the floppy drive. (Pin 5 is removed to prevent incorrect insertion when using ribbon cables with pin 5 plug).

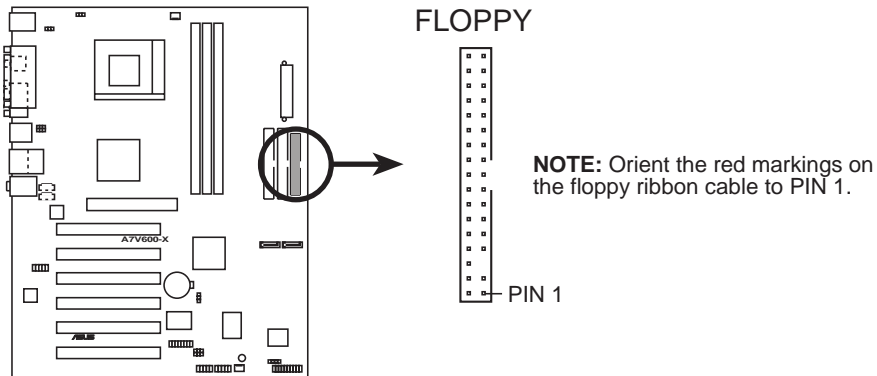

A7V600-X Floppy Disk Drive Connector

3. Chassis intrusion connector (4-1 pin CHASSIS)

This lead is for a chassis designed with intrusion detection feature. This requires an external detection mechanism such as a chassis intrusion sensor or microswitch. When you remove any chassis component, the sensor triggers and sends a high-level signal to this lead to record a chassis intrusion event.

By default, the pins labeled “Chassis Signal” and “Ground” are shorted with a jumper cap. If you wish to use the chassis intrusion detection feature, remove the jumper cap from the pins.

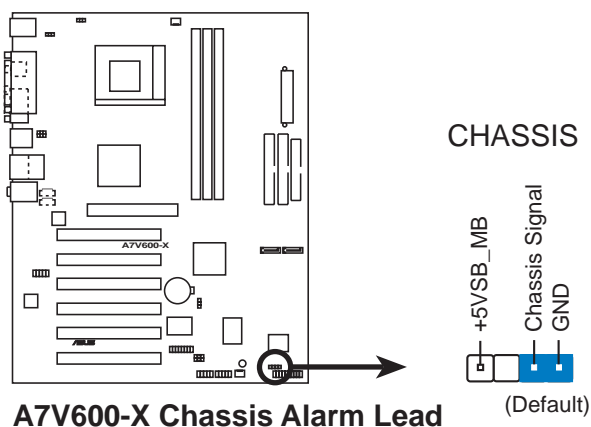

A7V600-X Chassis Alarm Lead

4. CPU and Chassis Fan Connectors (3-pin CPU_FAN, CHA_FAN)

The fan connectors support cooling fans of 350mA~740mA (8.88W max.) or a total of 1A~2.22A (26.64W max.) at +12V. Connect the fan cables to the fan connectors on the motherboard, making sure that the black wire of each cable matches the ground pin of the connector.



Do not forget to connect the fan cables to the fan connectors. Lack of sufficient air flow within the system may damage the motherboard components. These are not jumpers! DO NOT place jumper caps on the fan connectors!

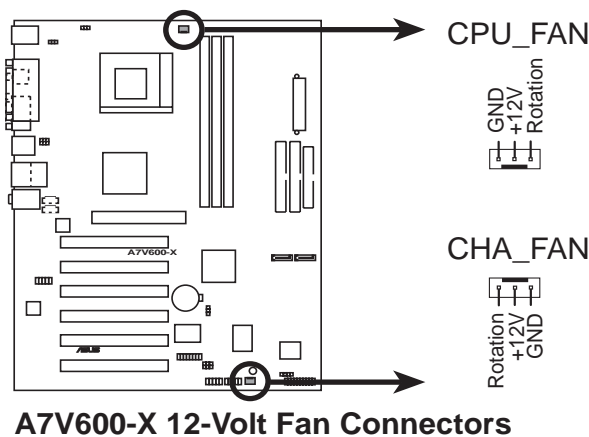

5. ATX power connectors (20-pin ATXPWR1)

These connectors connect to an ATX 12V power supply. The plugs from the power supply are designed to fit these connectors in only one orientation. Find the proper orientation and push down firmly until the connectors completely fit.



Make sure that your ATX 12V power supply can provide 8A on the +12V lead and at least 1A on the +5-volt standby lead (+5VSB). The minimum recommended wattage is 230W, or 300W for a fully configured system. The system may become unstable and may experience difficulty powering up if the power supply is inadequate.

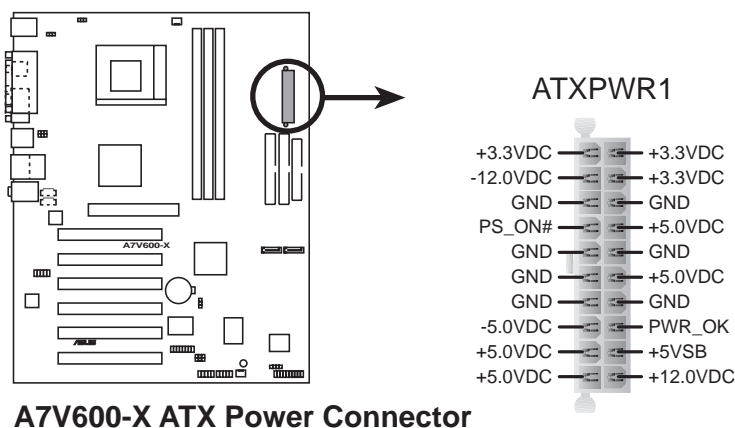

6. USB header (4-1 pin USB56, USB78)

If the USB ports on the rear panel are inadequate, a USB header is available for additional USB ports. The USB header complies with USB 2.0 specification that supports up to 480 Mbps connection speed. This speed advantage over the conventional 12 Mbps on USB 1.1. Connect a USB 2.0 module to this connector.

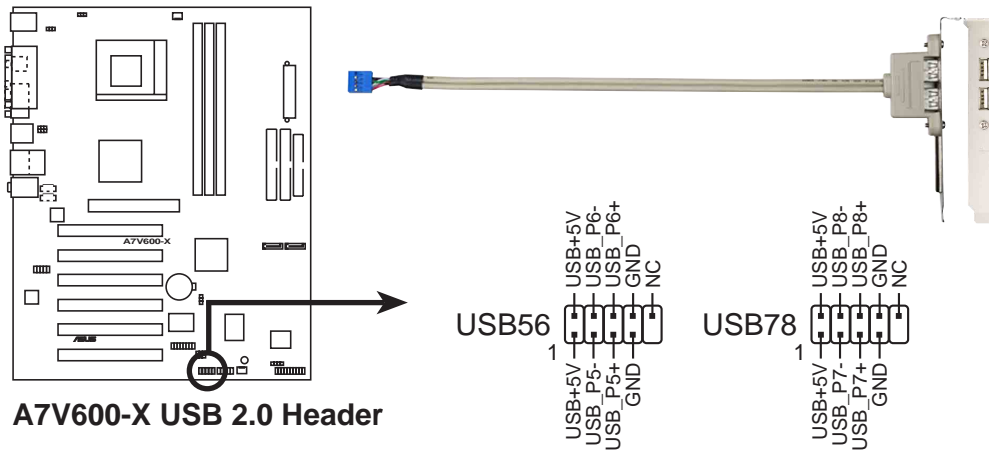

The USB 2.0 module is purchased separately.

7. Internal audio connectors (4-pin CD, AUX)

These connectors allow you to receive stereo audio input from sound sources such as a CD-ROM, TV tuner, or MPEG card.

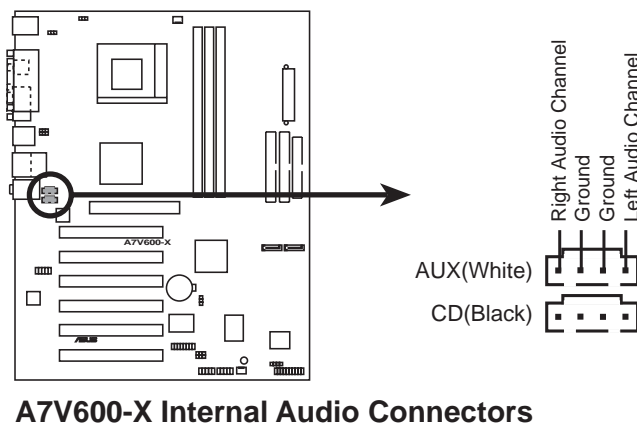

8. GAME/MIDI connector (16-1 pin GAME)

This connector supports a GAME/MIDI module. Connect the GAME/MIDI cable with yellow connector to the yellow header onboard. The GAME/MIDI port on the module connects a joystick or a game pad for playing games, and MIDI devices for playing or editing audio files.

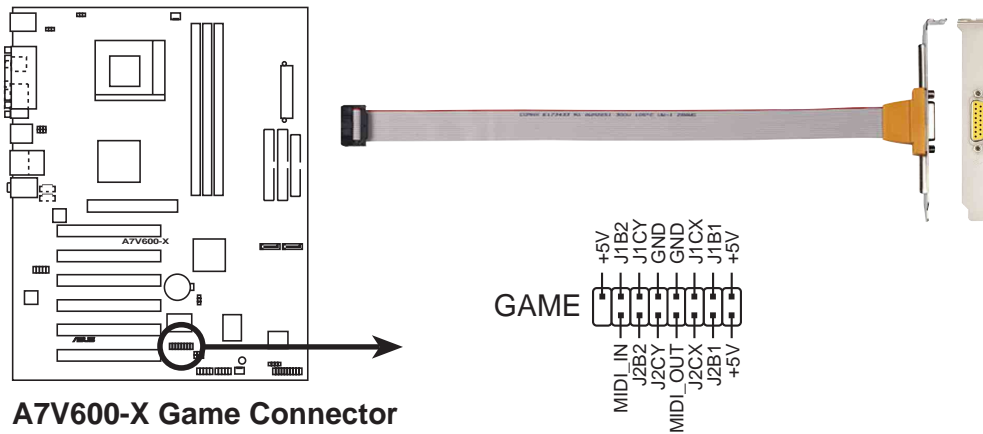

The GAME/MIDI module is purchased separately.

9. Front panel audio connector (10-1 pin FP_AUDIO)

This is an interface for the Intel front panel audio cable that allow convenient connection and control of audio devices.



Remove the caps from the Line out_R, BLINE_OUT_R, Line out_L and BLINE_OUT_L jumpers if you want to install an Intel front panel audio cable.

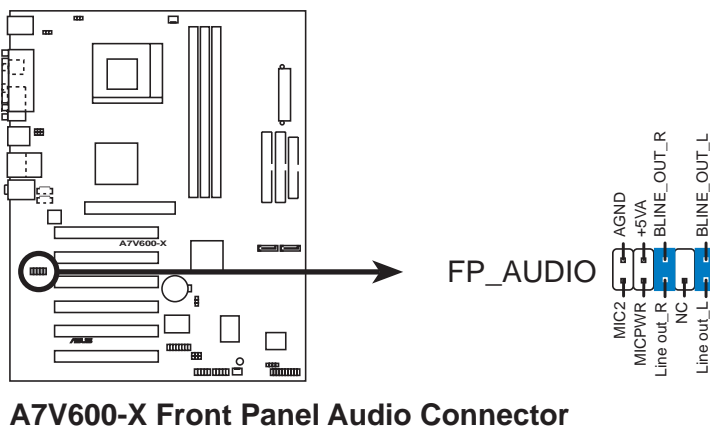

A7V600-X Front Panel Audio Connector

10. Serial ATA connector (7-pin SATA1, SATA2)

These connectors accommodate the primary serial ATA (SATA1) and a secondary serial ATA (SATA2) cables. Connect the serial ATA cable to this connector then install to a serial ATA ready hard disk.

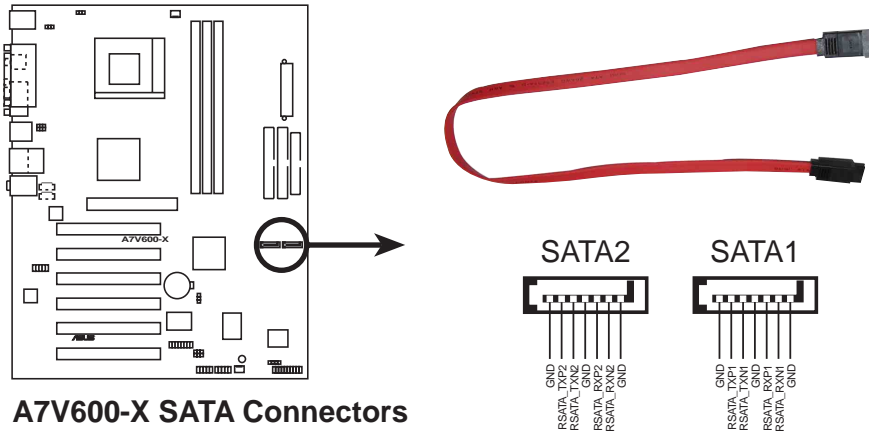

The SATA cable is purchased separately.

11. System panel connector (20-pin PANEL1)

This connector accommodates several system front panel functions.

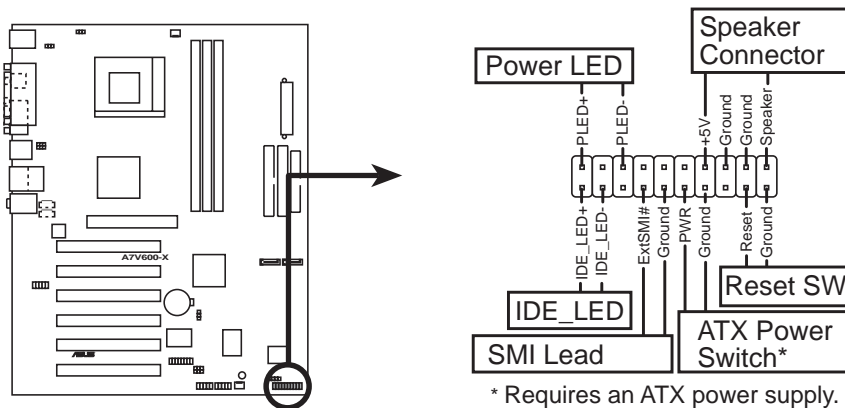

- **System Power LED Lead (3-1 pin PLED)**

This 3-1 pin connector connects to the system power LED. The LED lights up when you turn on the system power, and blinks when the system is in sleep mode.

- **System Warning Speaker Lead (4-pin SPKR)**

This 4-pin connector connects to the case-mounted speaker and allows you to hear system beeps and warnings.

- **Reset Switch Lead (2-pin RESET)**

This 2-pin connector connects to the case-mounted reset switch for rebooting the system without turning off the system power.

- **ATX Power Switch/Soft-off Switch Lead (2-pin PWR)**

This connector connects a switch that controls the system power. Pressing the power switch turns the system between ON and SLEEP, or ON and SOFT OFF, depending on the BIOS or OS settings. Pressing the power switch while in the ON mode for more than 4 seconds turns the system OFF.

- **System Management Interrupt Lead (2-pin SMI)**

This 2-pin connector allows you to manually place the system into a suspend mode, or “green” mode, where system activity is instantly decreased to save power and to expand the life of certain system components. Attach the case-mounted suspend switch to this 2-pin connector.

- **Hard Disk Activity Lead (2-pin IDE_LED)**

This connector supplies power to the hard disk activity LED. The read or write activities of any device connected to the primary or secondary IDE connector cause this LED to light up.

Chapter 2

This chapter tells how to change the system settings through the BIOS setup menus. Detailed descriptions of the BIOS parameters are also provided.

BIOS Information

2.1 Managing and Updating your BIOS

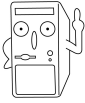

It is recommended that you save a copy of the motherboard's **original BIOS** to a bootable floppy disk in case you need to reinstall the original BIOS later.

2.1.1 Using ASUS EZ Flash to update the BIOS

The ASUS EZ Flash feature allows you to easily update the BIOS without having to go through the long process of booting from a diskette and using a DOS-based utility. The EZ Flash is built-in the BIOS firmware so it is accessible by simply pressing <Alt> + <F2> during the Power-On Self Tests (POST).

Follow these steps to update the BIOS using ASUS EZ Flash.

1. Download the latest BIOS file from the ASUS website (see ASUS contact information on page x). Save the file to a floppy disk.



Write down the BIOS file name on a piece of paper. You need to type the **exact BIOS file name** at the EZ Flash screen.

2. Reboot the computer.
3. To use EZ Flash, press <Alt> + <F2> during POST to display the following screen.

```
ASUS EZ Flash V1.00
Copyright (C) 2002, ASUSTeK COMPUTER INC.

[Onboard BIOS Information]
BIOS Version      : ASUS A7V600-X BIOS Revision 1001 Beta 003
BIOS Model       : A7V600-X
BIOS Built Date  : 06/03/03

Please Enter File Name for NEW BIOS: _
*Note: EZ Flash will copy file from A:\, Press [ESC] to reboot
```



The BIOS information in the above screen is for reference only. What you see on your screen may not be exactly the same as shown.

4. Insert the disk that contains the new BIOS file into the floppy drive. You will receive the error message, "**WARNING! Device not ready.**" if you proceed to step 5 without the disk in the drive.

- At the prompt, “**Please Enter File Name for NEW BIOS: _**”, type in the BIOS file name that you downloaded from the ASUS website, then press <Enter>. EZ Flash will automatically access drive A to look for the file name that you typed. When found, the following message appears on screen.

If you accidentally typed in a wrong BIOS file name, the error message, “**WARNING! File not found.**” appears. Press <Enter> to remove the message, then type in the correct file name. Press <Enter>.

- At the query prompt, type **Y** to continue with the update process. Pressing **N** exits the EZ Flash screen and reboots the system without updating the BIOS. The following prompts appear if you typed **Y**.

```
[BIOS Information in File]
BIOS Version:  A7V600-X Boot Block

WARNING! Continue to update the BIOS (Y/N)? _
```

- Press **Y** for both items to completely update the main BIOS area and the boot block area.

```
Flash Memory:  SST 49LF004

1. Update Main BIOS area      (Y/N)? _
2. Update Boot Block area     (Y/N)? _
```



DO NOT shutdown or reset the system while updating the BIOS boot block area! Doing so may cause system boot failure.

- When the update process is done, the message, “**Press a key to reboot**” appears. Press any key to reboot the system with the new BIOS.

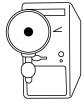

The BIOS information in the above screen is for reference only. What you see on your screen may not be exactly the same as shown.

2.1.2 Using AFLASH to update the BIOS

Creating a bootable disk

AFLASH.EXE is a Flash Memory Writer utility that updates the BIOS by uploading a new BIOS file to the programmable flash ROM on the motherboard. This file works only in DOS mode. To determine the BIOS version of your motherboard, check the last four numbers of the code displayed on the upper left-hand corner of your screen during bootup. Larger numbers represent a newer BIOS file.

1. Type `FORMAT A:/S` at the DOS prompt to create a bootable system disk. DO NOT copy `AUTOEXEC.BAT` and `CONFIG.SYS` to the disk.
2. Type `COPY D:\AFLASH\AFLASH.EXE A:\` (assuming D is your CD-ROM drive) to copy `AFLASH.EXE` to the boot disk you created.



AFLASH works only in DOS mode. It does not work with certain memory drivers that may be loaded when you boot from the hard drive. It is recommended that you reboot using a floppy disk.

3. Reboot the computer from the floppy disk.



BIOS setup must specify “Floppy” as the first item in the boot sequence.

4. In DOS mode, type `A:\AFLASH <Enter>` to run AFLASH.

```
ASUS ACPI BIOS
FLASH MEMORY WRITER V2.0
Copyright (C) 1994-2001 ASUSTEK COMPUTER INC.

Flash Memory: Winbond W29C020 or SST 29EE020 or Intel 82802AB

Current BIOS Version: ASUS XXX-XX ACPI BIOS Revision 100X
BIOS Model          : XXX-XX
BIOS Built Date     : 12/25/01

Choose one of the followings:
1. Save Current BIOS To File
2. Update BIOS Including Boot Block and ESCD

Enter choice: [1]

Press ESC To Exit
```



If the word “unknown” appears after Flash Memory:, the memory chip is either not programmable or is not supported by the ACPI BIOS and therefore, cannot be programmed by the Flash Memory Writer utility.

5. Select 1. Save Current BIOS to File from the Main menu and press <Enter>. The Save Current BIOS To File screen appears.

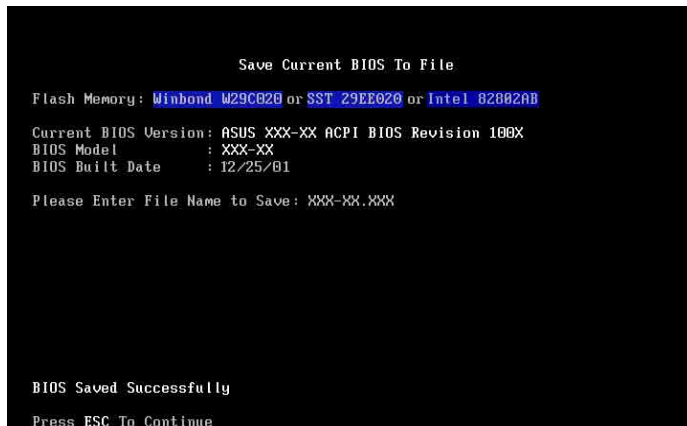

6. Type a filename and the path, for example, A:\XXX-XX.XXX, then press <Enter>.

Updating the BIOS



Update the BIOS only if you are sure that the new BIOS revision will solve your problems. Careless updating may result to more problems with the motherboard!

1. Download an updated ASUS BIOS file from the Internet (WWW or FTP) (see ASUS CONTACT INFORMATION on page x for details) and save to the boot floppy disk you created earlier.
2. Boot from the floppy disk.
3. At the “A:” prompt, type AFLASH and then press <Enter>.
4. At the Main Menu, type 2 then press <Enter>. The Update BIOS Including Boot Block and ESCD screen appears.
5. Type the filename of your new BIOS and the path, for example, A:\XXX-XX.XXX, then press <Enter>.

To cancel this operation, press <Enter>.

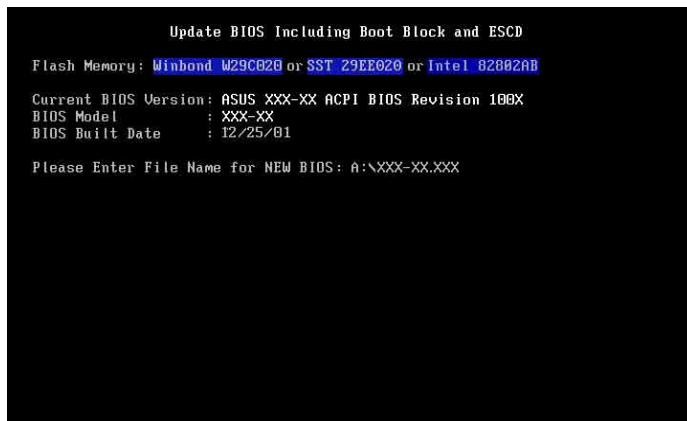

6. When prompted to confirm the BIOS update, press **Y** to start the update.

```
Update BIOS Including Boot Block and ESCD
Flash Memory: Winbond W29C020 or SST 29EE020 or Intel 82802AB
BIOS Version
[CURRENT ] ASUS XXX-XX ACPI BIOS Revision 100X
[test.awd] ASUS XXX-XX ACPI BIOS Revision 100X
BIOS Model
[CURRENT ] XXX-XX
[test.awd] XXX-XX
Date of BIOS Built
[CURRENT ] 09/25/99
[XXXX.XXX] 05/29/00
Check sum of 1001.010 is F266.
Are you sure (Y/N) ? [Y]
Press ESC To Return to Main Menu
```

7. The utility starts to program the new BIOS information into the Flash ROM. The boot block is updated automatically only when necessary. When the programming is done, the message *“Flashed Successfully”* appears.

```
Update BIOS Including Boot Block and ESCD
Flash Memory: Winbond W29C020 or SST 29EE020 or Intel 82802AB
BIOS Version
[CURRENT ] ASUS XXX-XX ACPI BIOS Revision 100X
[test.awd] ASUS XXX-XX ACPI BIOS Revision 100X
BIOS Model
[CURRENT ] XXX-XX
[test.awd] XXX-XX
Date of BIOS Built
[CURRENT ] 12/25/01
[XXXX.XXX] 05/29/00
Check sum of 1001.010 is F266.
Are you sure (Y/N) ? [Y]
Block Erasing -- Done
Programming -- 3FFFF
Flashed Successfully
Press ESC To Continue
```

8. Follow the onscreen instructions to continue.

```
ASUS ACPI BIOS
FLASH MEMORY WRITER V2.0
Copyright (C) 1994-2001 ASUSTeK COMPUTER INC.
Flash Memory: Winbond W29C020 or SST 29EE020 or Intel 82802AB
Current BIOS Version: ASUS XXX-XX ACPI BIOS Revision 100X
BIOS Model : XXX-XX
BIOS Built Date : 12/25/01
Choose one of the followings:
1. Save Current BIOS To File
2. Update BIOS Including Boot Block and ESCD
Enter choice: [1]
You have flashed the EPROM:It is recommended that you turn off
the power, enter SETUP and LOAD Setup Defaults to have CMOS
updated with new BIOS when exits.
Press ESC To Exit
```



DO NOT turn off the system while updating the BIOS. This may cause boot problems. Just repeat the process, and if the problem persists, load the original BIOS file you saved to the boot disk. If the Flash Memory Writer utility is not able to successfully update a complete BIOS file, call the ASUS service center for support.

2.1.3 Recovering the BIOS with CrashFree BIOS 2

The CrashFree BIOS 2 auto recovery tool allows you to restore BIOS from the motherboard support CD, or from a floppy disk that contains the BIOS file, in case the current BIOS on the motherboard fails or gets corrupted.

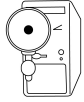

1. Prepare the **support CD** that came with the motherboard or a **floppy disk that contains the motherboard BIOS** before proceeding with the BIOS update process.
2. If you have saved a copy of the original motherboard BIOS to a bootable floppy disk, you may also use this disk to restore the BIOS. See section "4.1.1 Creating a bootable floppy disk."

To recover the BIOS from a floppy disk:

1. Boot the system.
2. When a corrupted BIOS is detected, the following screen message appears.

```
Bad BIOS checksum. Starting BIOS recovery...
Checking for floppy...
```

3. Insert a floppy disk that contains the original or the latest BIOS file for this motherboard. If all the necessary files are found in the floppy disk, the BIOS update process continues.

```
Bad BIOS checksum. Starting BIOS recovery...
Checking for floppy...
Floppy found!
Reading file "A7V600-X.rom". Completed.
Start flashing...
```



DO NOT shutdown or reset the system while updating the BIOS! Doing so may cause system boot failure!

4. When the BIOS update process is complete, reboot the system.

To recover the BIOS from the support CD:

1. Boot the system.
2. When a corrupted BIOS is detected, the following screen message appears.

```
Bad BIOS checksum. Starting BIOS recovery...
Checking for floppy...
```

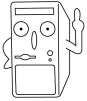

If there is no floppy disk found in the drive, the system automatically checks the CD-ROM.

3. Place the support CD in the CD-ROM. The support CD contains the original BIOS for this motherboard.

```
Bad BIOS checksum. Starting BIOS recovery...
Checking for floppy...
Floppy not found!
Checking for CD-ROM...
CD-ROM found.
Reading file "A7V600-X.rom". Completed.
Start flashing...
```



DO NOT shutdown or reset the system while updating the BIOS! Doing so may cause system boot failure!

4. When the BIOS update process is complete, reboot the system.

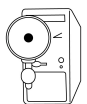

The recovered BIOS may not be the latest BIOS version for this motherboard. Visit ASUS website (www.asus.com) to download the latest BIOS file.

2.2 BIOS Setup program

Use the BIOS Setup program when you are installing a motherboard, reconfiguring your system, or prompted to “Run Setup”. This section explains how to configure your system using this utility.

Even if you are not prompted to use the Setup program, you may want to change the configuration of your computer in the future. For example, you may want to enable the security password feature or make changes to the power management settings. This requires you to reconfigure your system using the BIOS Setup program so that the computer can recognize these changes and record them in the CMOS RAM of the EEPROM.

The EEPROM on the motherboard stores the Setup utility. When you start up the computer, the system provides you with the opportunity to run this program. Press <Delete> during the Power-On Self Test (POST) to enter the Setup utility, otherwise, POST continues with its test routines.

The Setup program is designed to make it as easy to use as possible. It is a menu-driven program, which means you can scroll through the various sub-menus and make your selections among the predetermined choices.



Because the BIOS software is constantly being updated, the following BIOS setup screens and descriptions are for reference purposes only, and may not exactly match what you see on your screen.

2.2.1 BIOS menu bar

The top of the screen has a menu bar with the following selections:

MAIN	Use this menu to make changes to the basic system configuration.
ADVANCED	Use this menu to enable and make changes to the advanced features.
POWER	Use this menu to configure and enable Power Management features.
BOOT	Use this menu to configure the default system device used to locate and load the Operating System.
EXIT	Use this menu to exit the current menu or to exit the Setup program.

To access the menu bar items, press the right or left arrow key on the keyboard until the desired item is highlighted.

2.2.2 Legend bar

At the bottom of the Setup screen is a legend bar. The keys in the legend bar allow you to navigate through the various setup menus. The following table lists the keys found in the legend bar with their corresponding functions.

Navigation Key(s)	Function Description
<F1> or <Alt + H>	Displays the General Help screen from anywhere in the BIOS Setup
<Esc>	Jumps to the Exit menu or returns to the main menu from a sub-menu
Left or Right arrow	Selects the menu item to the left or right
Up or Down arrow	Moves the highlight up or down between fields
- (minus key)	Scrolls backward through the values for the highlighted field
+ (plus key) or spacebar	Scrolls forward through the values for the highlighted field
<Enter>	Brings up a selection menu for the highlighted field
<Home> or <PgUp>	Moves the cursor to the first field
<End> or <PgDn>	Moves the cursor to the last field
<F5>	Resets the current screen to its Setup Defaults
<F10>	Saves changes and exits Setup

General help

In addition to the Item Specific Help window, the BIOS setup program also provides a General Help screen. You may launch this screen from any menu by simply pressing <F1> or the <Alt> + <H> combination. The General Help screen lists the legend keys and their corresponding functions.

Saving changes and exiting the Setup program

See “2.7 Exit Menu” for detailed information on saving changes and exiting the setup program.

When a scroll bar appears to the right of a help window, it indicates that there is more information to be displayed that will not fit in the window. Use <PgUp> and <PgDn> or the up and down arrow keys to scroll through the entire help document. Press <Home> to display the first page, press <End> to go to the last page. To exit the help window, press <Enter> or <Esc>.

Sub-menu

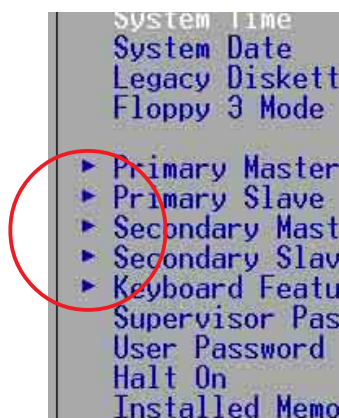

Note that a right pointer symbol (as shown on the left) appears to the left of certain fields. This pointer indicates that you can display a sub-menu from this field. A sub-menu contains additional options for a field parameter. To display a sub-menu, move the highlight to the field and press <Enter>. The sub-menu appears. Use the legend keys to enter values and move from field to field within a sub-menu as you would within a menu. Use the <Esc> key to return to the main menu. Take some time to familiarize yourself with the legend keys and their corresponding functions. Practice navigating through the various menus and sub-menus.

If you accidentally make unwanted changes to any of the fields, use the set default hot key <F5> to load the Setup default values. While moving around through the Setup program, note that explanations appear in the Item Specific Help window located to the right of each menu. This window displays the help text for the currently highlighted field.

2.3 Main Menu

When you enter the Setup program, the following screen appears.

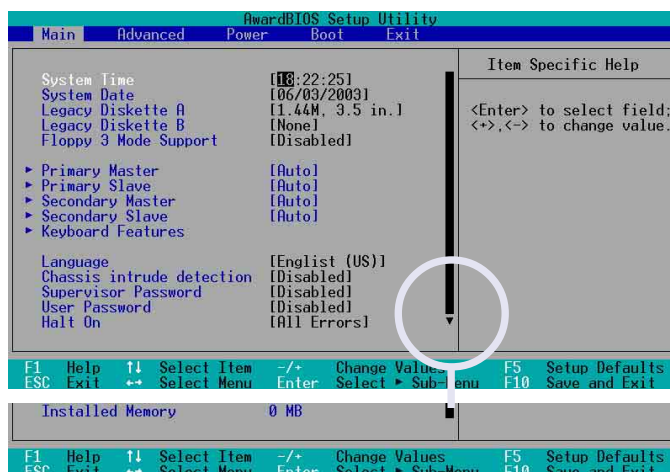

System Time [XX:XX:XX]

Sets the system to the time that you specify (usually the current time). The format is hour, minute, second. Valid values for hour, minute and second are Hour: (00 to 23), Minute: (00 to 59), Second: (00 to 59). Use the <Tab> or <Shift> + <Tab> keys to move between the hour, minute, and second fields.

System Date [XX/XX/XXXX]

Sets the system to the date that you specify (usually the current date). The format is month, day, year. Valid values for month, day, and year are Month: (1 to 12), Day: (1 to 31), Year: (up to 2099). Use the <Tab> or <Shift> + <Tab> keys to move between the month, day, and year fields.

Legacy Diskette A, B [1.44M, 3.5 in.]

Sets the type of floppy drive installed. Configuration options: [None] [360K, 5.25 in.] [1.2M, 5.25 in.] [720K, 3.5 in.] [1.44M, 3.5 in.] [2.88M, 3.5 in.]

Floppy 3 Mode Support [Disabled]

This is required to support older Japanese floppy drives. The Floppy 3 Mode feature allows reading and writing of 1.2MB (as opposed to 1.44MB) on a 3.5-inch diskette. Configuration options: [Disabled] [Enabled]

Language [English US]

This field allows you to choose the BIOS language version from the available options.

Chassis Intrusion Detection [Disabled]

This field allows you to enable or disable the chassis intrusion detection feature.

Supervisor Password [Disabled] / User Password [Disabled]

These fields allow you to set passwords. To set a password, highlight the appropriate field and press <Enter>. Type in a password then press <Enter>. You can type up to eight alphanumeric characters. Symbols and other characters are ignored. To confirm the password, type the password again and press <Enter>. The password is now set to [Enabled]. This password allows full access to the BIOS Setup menus. To clear the password, highlight this field and press <Enter>. The same dialog box as above appears. Press <Enter>. The password is set to [Disabled].



Make a copy of the original BIOS on a bootable floppy disk before setting passwords. You will need to upload the BIOS file in case you erase the CMOS RAM in the future.

A note about passwords

The BIOS Setup program allows you to specify passwords in the Main menu. The passwords control access to the BIOS during system startup. Passwords are not case sensitive, meaning, passwords typed in either uppercase or lowercase letters are accepted. The BIOS Setup program allows you to specify two different passwords: a Supervisor password and a User password. If you did not set a Supervisor password, anyone can access the BIOS Setup program. If you did, the Supervisor password is required to enter the BIOS Setup program and to gain full access to the configuration fields.

Forgot the password?

If you forget your password, you can clear it by erasing the CMOS Real Time Clock (RTC) RAM. The RAM data containing the password information is powered by the onboard button cell battery. If you need to erase the CMOS RAM, unplug the all the power cables and remove the button cell battery. Re-install the battery after about 2 seconds, then power up the system. Refer to section “2.1 Managing and updating your BIOS” on how to update the BIOS.

Halt On [All Errors]

This field specifies the types of errors that will cause the system to halt.

Configuration options: [All Errors] [No Error] [All but Keyboard] [All but Disk] [All but Disk/Keyboard]

Installed Memory [XXX MB]

This field automatically displays the amount of conventional memory detected by the system during the boot process.

2.3.1 Primary and Secondary Master/Slave

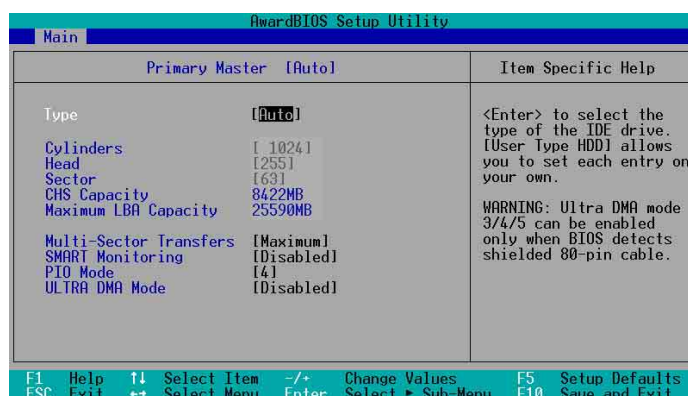

Type [Auto]

Select [Auto] to automatically detect an IDE hard disk drive. If automatic detection is successful, Setup automatically fills in the correct values for the remaining fields on this sub-menu. If automatic detection fails, select [User Type HDD] to manually enter the IDE hard disk drive parameters. Refer to the next section for details.



Before attempting to configure a hard disk drive, make sure you have the correct configuration information supplied by the drive manufacturer.

[User Type HDD]



Manually enter the number of cylinders, heads and sectors per track for the drive. Refer to the drive documentation or label for this information.

If no drive is installed or if you are removing a drive and not replacing it, select [None].

Other options for the Type field are:

[CD-ROM] - for IDE CD-ROM drives

[LS-120] - for LS-120 compatible floppy disk drives

[ZIP] - for ZIP-compatible disk drives

[MO] - for IDE magneto optical disk drives

[Other ATAPI Device] - for IDE devices not listed here

After making your selections on this sub-menu, press the <Esc> key to return to the Main menu. When the Main menu appears, the hard disk drive field displays the size for the hard disk drive that you configured.

Translation Method [LBA]

Select the hard disk drive type in this field. When Logical Block Addressing (LBA) is enabled, the 28-bit addressing of the hard drive is used without regard for cylinders, heads, or sectors. Note that LBA Mode is necessary for drives with more than 504MB storage capacity. Configuration options: [LBA] [LARGE] [Normal] [Match Partition Table] [Manual]

Cylinders

This field configures the number of cylinders. Refer to the drive documentation to determine the correct value. To make changes to this field, set the Type field to [User Type HDD] and the Translation Method field to [Manual].

Head

This field configures the number of read/write heads. Refer to the drive documentation to determine the correct value. To make changes to this field, set the Type field to [User Type HDD] and the Translation Method field to [Manual].

Sector

This field configures the number of sectors per track. Refer to the drive documentation to determine the correct value. To make changes to this field, set the Type field to [User Type HDD] and the Translation Method field to [Manual].

CHS Capacity

This field shows the drive's maximum CHS capacity as calculated by the BIOS based on the drive information you entered.

Maximum LBA Capacity

This field shows the drive's maximum LBA capacity as calculated by the BIOS based on the drive information you entered.

Multi-Sector Transfers [Maximum]

This option automatically sets the number of sectors per block to the highest number that the drive supports. Note that when this field is automatically configured, the set value may not always be the fastest value for the drive. You may also manually configure this field. Refer to the documentation that came with the hard drive to determine the optimum value and set it manually. To make changes to this field, set the Type field to [User Type HDD]. Configuration options: [Disabled] [2 Sectors] [4 Sectors] [8 Sectors] [16 Sectors] [32 Sectors] [Maximum]

SMART Monitoring [Disabled]

This field allows you to enable or disable the S.M.A.R.T. (Self-Monitoring, Analysis and Reporting Technology) system that utilizes internal hard disk drive monitoring technology. This parameter is normally disabled because the resources used in the SMART monitoring feature may decrease system performance. Configuration options: [Disabled] [Enabled]

PIO Mode [4]

This option lets you set a PIO (Programmed Input/Output) mode for the IDE device. Modes 0 through 4 provide successive increase in performance. Configuration options: [0] [1] [2] [3] [4]

Ultra DMA Mode [Disabled]

Ultra DMA capability allows improved transfer speeds and data integrity for compatible IDE devices. Set to [Disabled] to suppress Ultra DMA capability. To make changes to this field, set the Type field to [User Type HDD]. Configuration options: [0] [1] [2] [3] [4] [5] [6] [Disabled]

2.3.2 Keyboard Features

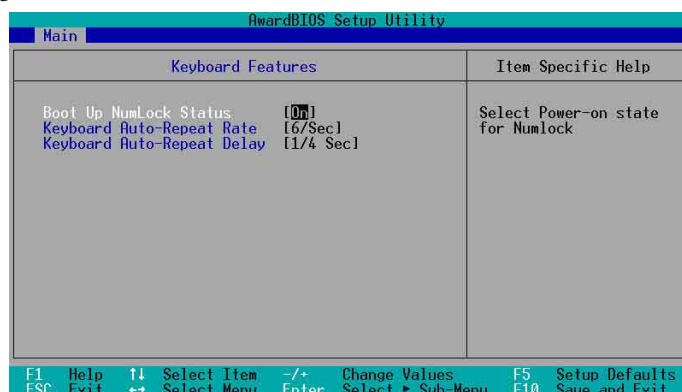

Boot Up NumLock Status [On]

This field enables users to activate the Number Lock function upon system boot. Configuration options: [Off] [On]

Keyboard Auto-Repeat Rate [12/Sec]

This controls the speed at which the system registers repeated keystrokes. Options range from 6 to 30 characters per second. Configuration options: [6/Sec] [8/Sec] [10/Sec] [12/Sec] [15/Sec] [20/Sec] [24/Sec] [30/Sec]

Keyboard Auto-Repeat Delay [1/4 Sec]

This field sets the time interval for displaying the first and second characters. Configuration options: [1/4 Sec] [1/2 Sec] [3/4 Sec] [1 Sec]

2.4 Advanced Menu

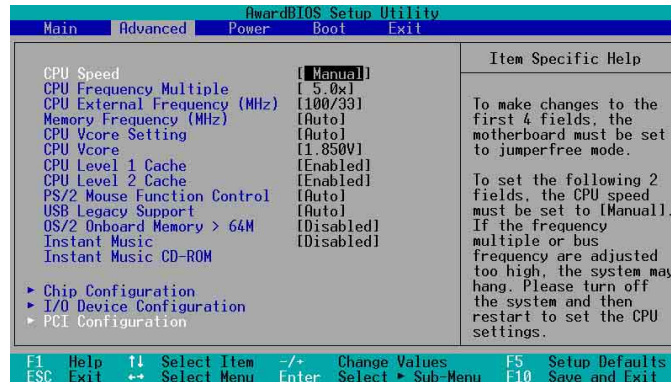

CPU Speed

This displays the current speed of the CPU installed.

CPU Frequency Multiple

This field displays frequency multiple value between the CPU's internal frequency (CPU speed) and external frequency.

CPU External Frequency (MHz)

This feature tells the clock generator what frequency to send to the system bus and PCI bus. The bus frequency (external frequency) multiplied by the bus multiple equals the CPU speed.

Memory Frequency (MHz)

This field determines the memory clock frequency. Configuration options: [Auto] [266] [333] [400].

CPU VCore Setting [Auto]

The [Manual] setting allows you to manually select the core voltage supplied to the CPU (see next item). It is recommended that you keep the default setting [Auto] to allow the system to automatically determine the appropriate CPU core voltage.

CPU VCore

When the CPU VCore Setting parameter above is set to [Manual], the CPU VCore item allows you to select a specific CPU core voltage. This field is not accessible when the CPU VCore Setting is set to [Auto].

CPU Level 1 Cache, CPU Level 2 Cache [Enabled]

These fields allow you to choose from the default [Enabled] or choose [Disabled] to turn on or off the CPU Level 1 and Level 2 built-in cache. Configuration options: [Disabled] [Enabled]

PS/2 Mouse Function Control [Auto]

The default setting [Auto] allows the system to detect a PS/2 mouse at startup. If a mouse is detected, the BIOS assigns IRQ12 to the PS/2 mouse. Otherwise, IRQ12 can be used for expansion cards. When you set this field to [Enabled], BIOS reserves IRQ12, whether or not a PS/2 mouse is detected at startup. Configuration options: [Enabled] [Auto]

USB Legacy Support [Auto]

This motherboard supports Universal Serial Bus (USB) devices. The default of [Auto] allows the system to detect a USB device at startup. If detected, the USB controller legacy mode is enabled. If not detected, the USB controller legacy mode is disabled.

When you set this field to [Disabled], the USB controller legacy mode is disabled whether or not you are using a USB device. Configuration options: [Disabled] [Enabled] [Auto]

OS/2 Onboard Memory > 64M [Disabled]

When using OS/2 operating systems with installed DRAM of greater than 64MB, you need to set this option to [Enabled]. Otherwise, leave to the default setting [Disabled]. Configuration options: [Disabled] [Enabled]

Instant Music [Disabled]

Allows you to enable or disable the Instant Music feature in BIOS. Configuration options: [Disabled] [Enabled]



When Instant Music is enabled, the PS/2 keyboard power up feature is automatically disabled.

Instant Music CD ROM

Allows you to select the CD-ROM drive that you wish to use for the Instant Music CD playback. Configuration options depends on the optical drives installed on your system.



The above item appears only if you enabled the Instant Music item.

2.4.1 Chip Configuration

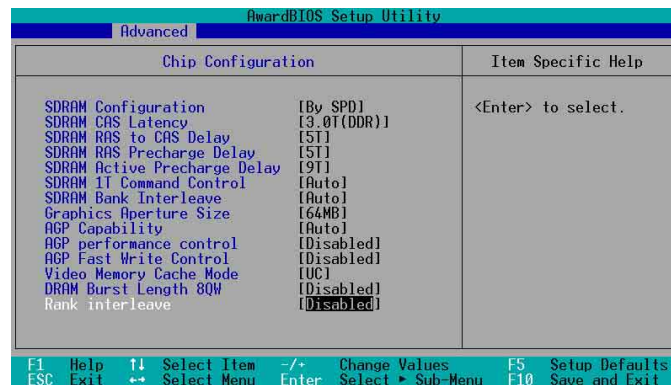

SDRAM Configuration [By SPD]

This parameter allows you to set the optimal timings for items 2–5, depending on the memory modules that you are using. The default setting is [By SPD], which configures items 2–5 by reading the contents in the SPD (Serial Presence Detect) device. The EEPROM on the memory module stores critical information about the module, such as memory type, size, speed, voltage interface, and module banks. Configuration options: [User Defined] [By SPD]



The SDRAM parameters (items 2~5) become configurable only when you set the SDRAM Configuration to [User Defined].

SDRAM CAS Latency (value depends on SDRAM SPD)

This item controls the latency between the SDRAM read command and the time the data actually becomes available. Configuration options: [1.5T] [2T] [2.5T]

SDRAM RAS to CAS Delay (value depends on SDRAM SPD)

This item controls the latency between the DDR SDRAM active command and the read/write command. Configuration options: [5T] [4T] [3T] [2T].

SDRAM RAS Precharge Delay (value depends on SDRAM SPD)

This item controls the idle clocks after issuing a precharge command to the DDR SDRAM. Configuration options: [5T] [4T] [3T] [2T]

SDRAM Active Precharge Delay (value depends on SDRAM SPD)

This item controls the number of DDR SDRAM clocks used for DDR SDRAM parameters. Configuration options: [9T] [8T] [7T] [6T]

SDRAM 1T Command Control

Configuration options: [Disabled] [Enabled] [Auto]

SDRAM Bank Interleave

Configuration options: [Disabled] [2 Bank] [4 Bank] [Auto]

Graphics Aperture Size [64MB]

This feature allows you to select the size of mapped memory for AGP graphic data.

Configuration options: [4MB] [8MB] [16MB] [32MB] [64MB] [128MB] [256MB] [512MB] [1024MB]



The [1024MB] and [512MB] configuration options are available only when you use AGP 8X graphics card.

AGP Capability [8X Mode]

This motherboard supports the AGP 8X interface that enables enhanced graphics performance with high bandwidth speeds up to 2.12GB/s. AGP8X is backward-compatible. When set to [1X Mode], the AGP interface only provides a peak data throughput of 266MB/s even if you are using an AGP 8X card.

Configuration options: [Auto] [1X Mode] [2X Mode] [4X Mode] [8X Mode]

AGP Drive Strength [Auto]

Configuration options: [Auto] [Manual]

Configuration options: [0][1][2][3][4][5][6][7][8][9][A][B][C][D][E][F]

AGP performance control [Disabled]

Configuration options: [Disabled] [Enabled]

AGP Fast Write control [Disabled]

Configuration options: [Disabled] [Enabled]

Video Memory Cache Mode [UC]

USWC (uncacheable, speculative write combining) is a new cache technology for the video memory of the processor. It can greatly improve the display speed by caching the display data. You must set this to UC (uncacheable) if your display card does not support this feature, otherwise the system may not boot.

Configuration options: [UC] [USWC]

DRAM Burst Length 8QW [Disabled]

This item enables or disables the DRAM Burst Length 8QW. Configuration options: [Disabled] [Auto]

Rank Interleave [Disabled]

This item enables or disables the rank interleave item. Configuration options: [Disabled] [Auto]

2.4.2 I/O Device Configuration

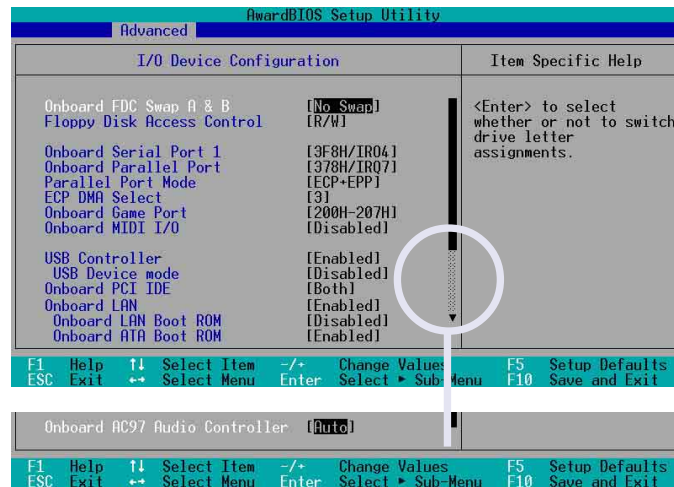

Onboard FDC Swap A & B

These fields set option to switch drive letter assignments. Configuration Options: [No Swap] [Swap AB]

Floppy Disk Access Control [R/W]

When set to [Read Only], this item protects files from being copied to floppy disks by allowing reads from, but not writes to, the floppy disk drive. The default setting [R/W] allows both reads and writes. Configuration options: [R/W] [Read Only]

Onboard Serial Port 1 [3F8H/IRQ4]

This field allows you to set the address for the onboard serial connector. Configuration options: [3F8H/IRQ4] [2F8H/IRQ3] [3E8H/IRQ4] [2E8H/IRQ10] [Disabled]

Onboard Parallel Port [378H/IRQ7]

This field allows you to set the address of the onboard parallel port connector. If you disable this field, the Parallel Port Mode and ECP DMA Select configurations are not available. Configuration options: [Disabled] [378H/IRQ7] [278H/IRQ5]

Parallel Port Mode [ECP+EPP]

This field allows you to set the operation mode of the parallel port. [Normal] allows normal-speed operation but in one direction only; [EPP] allows bidirectional parallel port operation; [ECP] allows the parallel port to operate in bidirectional DMA mode; [ECP+EPP] allows normal speed operation in a two-way mode. Configuration options: [Normal] [EPP] [ECP] [ECP+EPP]

ECP DMA Select [3]

This field allows you to configure the parallel port DMA channel for the selected ECP mode. This selection is available only if you select [ECP] or [ECP+EPP] in Parallel Port Mode above. Configuration options: [1] [3]

Onboard Game Port [200H-207H]

These fields allow you to set the addresses for the onboard game connectors. Game ports must have different addresses. Configuration options: [200H/207H] [208H-20FH] [Disabled]

Onboard MIDI I/O [Disabled]

These fields allow you to set the addresses for the onboard MIDI connectors. MIDI ports must have different addresses. Configuration options: [330H-331H] [300H-301H] [Disabled]

USB Controller [Enabled]

These fields allow you to enable or disable the onboard USB controller. Configuration options: [Disabled] [Enabled]

USB Device Mode [Disabled]

These fields allow you to enable or disable the USB device mode Configuration options: [Disabled] [Enabled]

Onboard PCI IDE [Both]

These fields allow you to select or disable the onboard PCI IDE drive for use. Configuration options: [Both] [Primary] [Secondary] [Disabled]

Onboard LAN [Enabled]

These fields allow you to enable or disable the onboard LAN controller. Configuration options: [Disabled] [Enabled]

Onboard LAN Boot ROM [Enabled]

These fields allow you to enable or disable the onboard LAN boot ROM. Configuration options: [Disabled] [Enabled]

Onboard ATA Boot ROM [Enabled]

These fields allow you to enable or disable the onboard Serial ATA controller boot ROM. Configuration options: [Disabled] [Enabled]

Onboard AC97 Audio Controller [Auto]

These fields allow you to disable or set to auto detect the onboard AC97 audio controller. Configuration options: [Auto] [Disabled]

2.4.3 PCI Configuration

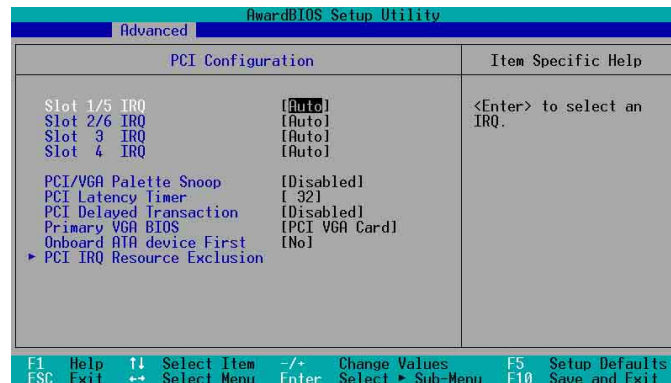

Slot 1/5, Slot 2/6, Slot 3, Slot 4 IRQ [Auto]

These fields automatically assign the IRQ for each PCI slot. The default setting for each field is [Auto], which utilizes auto-routing to determine IRQ assignments.

Configuration options: [Auto] [NA] [3] [4] [5] [7] [9] [10] [11] [12] [14] [15]

PCI/VGA Palette Snoop [Disabled]

Some non-standard VGA cards, like graphics accelerators or MPEG video cards, may not show colors properly. Setting this field to [Enabled] corrects this problem. If you are using standard VGA cards, leave this field to the default setting [Disabled]. Configuration options: [Disabled] [Enabled]

PCI Latency Timer [32]

Leave this field to the default setting [32] for best performance and stability.

PCI Delayed Transaction [Disabled]

This field enables or disables the PCI delayed transaction function. Configuration options: [Disabled] [Enabled]

Primary VGA BIOS [PCI VGA Card]

This field allows you to select the primary graphics card. Configuration options: [PCI VGA Card] [AGP VGA Card]

Onboard ATA device First [No]

This field allows you to select the onboard ATA first. Configuration options: [No] [Yes]

PCI IRQ Resource Exclusion

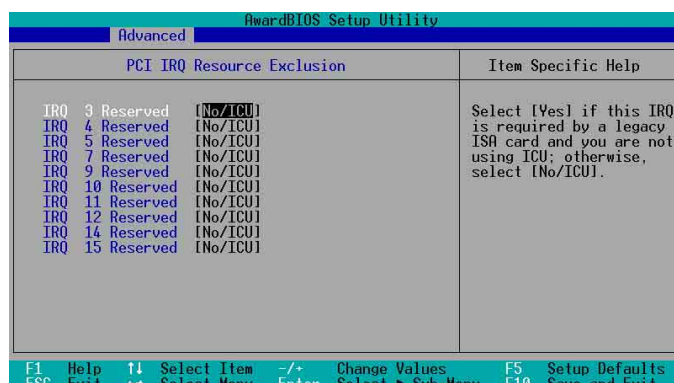

IRQ XX Reserved [No/ICU]

These fields indicate whether or not the displayed IRQ for each field is being used by a legacy (non-PnP) ISA card. The setting [No/ICU] for an IRQ field indicates that you are using the ISA Configuration Utility (ICU), and that this particular IRQ is NOT required by a legacy ISA card. Set the IRQ field to [Yes] if you install a legacy ISA card that requires a unique IRQ and you are NOT using ICU. Configuration options: [No/ICU] [Yes]

2.5 Power Menu

The Power menu allows you to reduce power consumption. This feature turns off the video display and shuts down the hard disk after a period of inactivity.

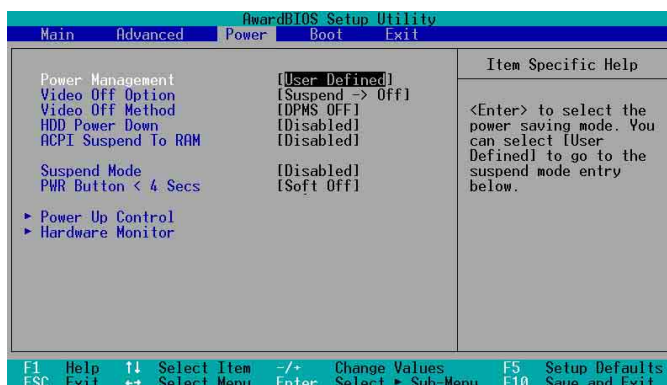

Power Management [User Defined]

This field allows you to activate or deactivate the automatic power saving features. When set to [Disabled], the power management features do not function regardless of the other settings on this menu. The [User Defined] option allows you to set the period of inactivity before the system enters suspend mode. Refer to "Suspend Mode" later in this section.

When set to [Max Saving], system power is conserved to its greatest amount. This setting automatically puts the system into suspend mode after a brief period of system inactivity. [Min Saving] allows the least power saving as the system enters suspend mode only after a long period of inactivity. Configuration options: [User Defined] [Disabled] [Min Saving] [Max Saving]



You should install the Advanced Power Management (APM) utility to keep the system time updated even when the computer enters suspend mode. In Windows 3.x and Windows 95, you need to install Windows with the APM feature. In Windows 98 or later, APM is automatically installed as indicated by a battery and power cord icon labeled “Power Management” in the Control Panel. Select the item “Advanced” in the Power Management Properties dialog box.

Video Off Option [Suspend -> Off]

This field determines when to activate the video off feature for monitor power management. Configuration options: [Always On] [Suspend -> Off]

Video Off Method [DPMS OFF]

This field defines the video off features. The Display Power Management System (DPMS) feature allows the BIOS to control the video display card if it supports the DPMS feature. [Blank Screen] only blanks the screen. Use this for monitors without power management or “green” features.

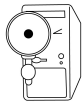

Even if installed, your screen saver does not display when you select [Blank Screen] for the above field.

[V/H SYNC+Blank] blanks the screen and turns off vertical and horizontal scanning. Configuration options: [Blank Screen] [V/H SYNC+Blank] [DPMS Standby] [DPMS Suspend] [DPMS OFF] [DPMS Reduce ON]

HDD Power Down [Disabled]

Shuts down any IDE hard disk drives in the system after a period of inactivity as set in this user-configurable field. This feature does not affect SCSI hard drives. Configuration options: [Disabled] [1 Min] [2 Min] [3 Min]...[15 Min]

ACPI Suspend To RAM [Disabled]

This field allows you to enable or disable the ACPI Suspend-to-RAM feature. To support this feature, the +5VSB of the power supply should have the capacity to provide more than 720mA current. Configuration options: [Disabled] [Enabled]

Suspend Mode [Disabled]

Sets the time period before the system goes into suspend mode. Configuration options: [Disabled] [1~2 Min] [2~3 Min] [4~5 min] [8~9 Min] [20 Min] [30 Min]

PWR Button < 4 Secs [Soft Off]

When set to [Soft off], the ATX switch can be used as a normal system power-off button when pressed for less than 4 seconds. [Suspend] allows the button to have a dual function where pressing less than 4 seconds puts the system in sleep mode. Regardless of the setting, holding the ATX switch for more than 4 seconds powers off the system. Configuration options: [Soft off] [Suspend]

2.5.1 Power Up Control

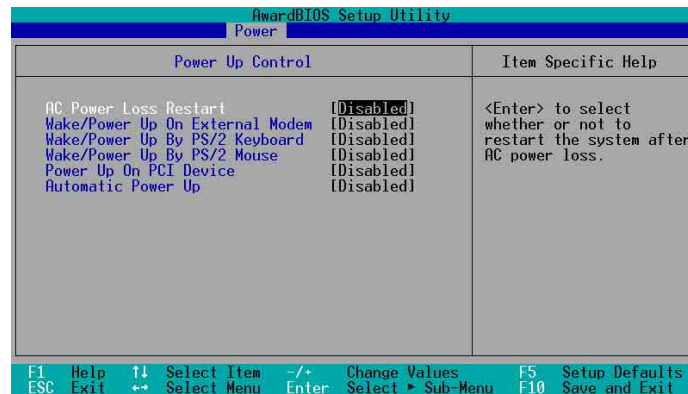

AC Power Loss Restart [Disabled]

This allows you to set whether or not to reboot the system after power interruptions. [Disabled] leaves your system off while [Enabled] reboots the system. [Previous State] sets the system back to the state it was before the power interruption. Configuration options: [Disabled] [Enabled] [Previous State]

Wake/Power Up On External Modem [Disabled]

This allows either settings of [Enabled] or [Disabled] for powering up the computer when the external modem receives a call while the computer is in Soft-off mode. Configuration options: [Disabled] [Enabled]

Wake/Power On By PS/2 Keyboard [Disabled]

This parameter allows you to use specific keys on the keyboard to turn on the system. This feature requires an ATX power supply that provides at least 1A on the +5VSB lead. Configuration options: [Disabled] [Space Bar] [Ctrl-Esc] [Power Key]

Wake/Power On By PS/2 Mouse [Disabled]

When set to [Double Click], this parameter allows you to use the PS/2 mouse to turn on the system. This feature requires an ATX power supply that provides at least 1A on the +5VSB lead. Configuration options: [Disabled] [Double Click]

Power Up On PCI Card [Disabled]

When set to [Enabled], this parameter allows you to turn on the system through a PCI LAN or modem card. This feature requires an ATX power supply that provides at least 1A on the +5VSB lead. Configuration options: [Disabled] [Enabled]

Automatic Power Up [Disabled]

This allows an unattended or automatic system power up. You may configure your system to power up at a certain time of the day by selecting [Everyday] or at a certain time and day by selecting [By Date]. Configuration options: [Disabled] [Everyday] [By Date]

Date of Month Alarm

This item appears only when you set the **Automatic Power Up** item to [By Date]. This allows you to key-in the date of current month to power up the system. Make sure to set the time of alarm after setting this item.

Time (hh:mm:ss) Alarm

This item appears only when you set the **Automatic Power Up** item to [By Date] or [Everyday]. This allows you to key-in the hour, minute and second of the day to power up the system.

2.5.2 Hardware Monitor

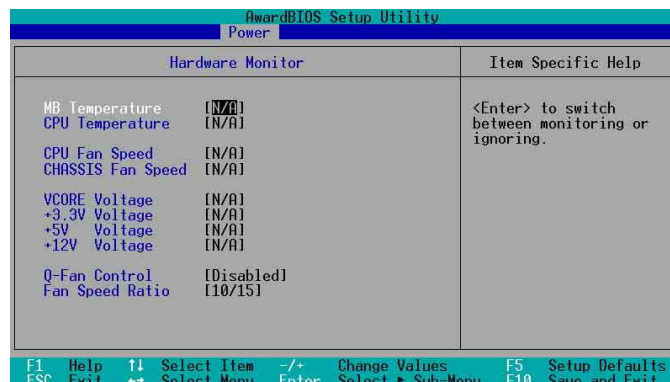

MB Temperature [xxxC/xxxF]

CPU Temperature [xxxC/xxxF]

The onboard hardware monitor automatically detects and displays the motherboard and CPU temperatures.

CPU Fan Speed [xxxxRPM] or [N/A]

Chassis Fan Speed [xxxxRPM] or [N/A]

The onboard hardware monitor automatically detects and displays the CPU and chassis fan speeds in rotations per minute (RPM). If any of the fans is not connected to the motherboard, that field shows N/A.

VCORE Voltage, +3.3V Voltage, +5V Voltage, +12V Voltage

The onboard hardware monitor automatically detects the voltage output through the onboard voltage regulators.



If any of the monitored items is out of range, the following error message appears: "Hardware Monitor found an error. Enter Power setup menu for details". You will then be prompted to "Press F1 to continue or DEL to enter SETUP".

2.6 Boot Menu

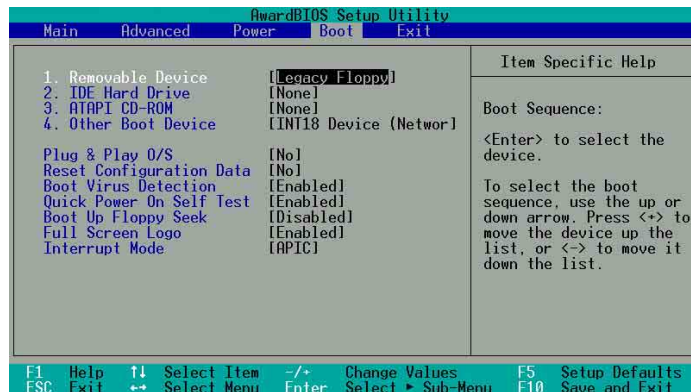

Boot Sequence

The Boot menu allows you to select four types of boot devices using the up and down arrow keys. By using the <+> or <Space> key, you can promote devices and by using the <-> key, you can demote devices. Promotion or demotion of devices alters the priority which the system uses to boot device on system power up. Configuration fields include Removable Devices, IDE Hard Drive, ATAPI CD-ROM, and Other Boot Device.

Removable Device [Legacy Floppy]

Configuration options: [Disabled] [Legacy Floppy] [LS-120] [ZIP] [ATAPIMO] [USB FDD] [USB ZIP/Flash]

IDE Hard Drive

This field allows you to select which IDE hard disk drive to use in the boot sequence. Pressing [Enter] will show the product IDs of all connected IDE hard disk drives.

ATAPI CD-ROM

This field allows you to select which ATAPI CD-ROM drive to use in the boot sequence. Pressing [Enter] will show the product IDs of all your connected ATAPI CD-ROM drives.

Other Boot Device [INT18 Device (Network)]

Configuration options: [Disabled] [SCSI Boot Device] [INT18 Device (Network)]

Plug & Play O/S [No]

This field allows you to use a Plug-and-Play (PnP) operating system to configure the PCI bus slots instead of using the BIOS. When [Yes] is selected, interrupts may be reassigned by the OS. If you installed a non-PnP OS or if you want to prevent reassigning of interrupt settings, keep the default setting [No]. Configuration options: [No] [Yes]

Reset Configuration Data [No]

The Extended System Configuration Data (ESCD) contain information about non-PnP devices. It also holds the complete record of how the system was configured the last time it was booted. Select [Yes] if you want to clear these data during the Power-On-Self-Test (POST). Configuration options: [No] [Yes]

Boot Virus Detection [Enabled]

This field allows you to set boot virus detection, ensuring a virus-free boot sector. The system halts and displays a warning message when it detects a virus. If this occurs, you can either allow the operation to continue or use a virus-free bootable floppy disk to restart and investigate your system. Configuration options: [Disabled] [Enabled]

Quick Power On Self Test [Enabled]

This field speeds up the Power-On-Self Test (POST) routine by skipping retesting a second, third, and fourth time. Configuration options: [Disabled] [Enabled]

Boot Up Floppy Seek [Enabled]

When enabled, the BIOS will seek the floppy disk drive to determine whether the drive has 40 or 80 tracks. Configuration options: [Disabled] [Enabled]

Full Screen Logo [Enabled]

This allows you to enable or disable the full screen logo display feature. Configuration options: [Disabled] [Enabled]

Interrupt Mode [APIC]

The Advanced Programmable Interrupt Controller (APIC) setting allows you to distribute interrupt routings other than the 16 IRQs. The Programmable Interrupt Controller (PIC) setting allows you to use the 16 IRQs only. Configuration options: [PIC] [APIC]

2.7 Exit Menu

When you have made all of your selections from the various menus in the Setup program, save your changes and exit Setup. Select Exit from the menu bar to display the following menu.

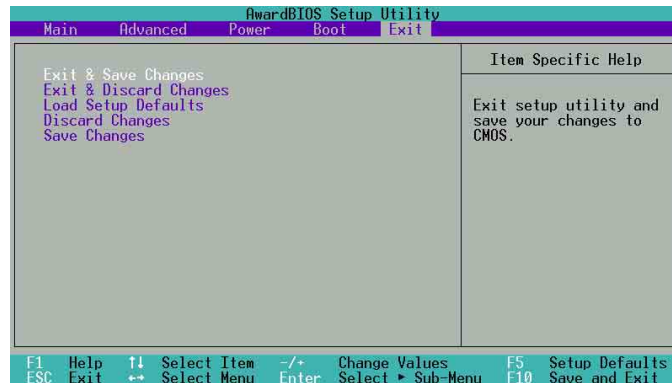

Pressing <Esc> does not immediately exit this menu. Select one of the options from this menu or <F10> from the legend bar to exit.

Exit Saving Changes

Once you are finished making your selections, choose this option from the Exit menu to ensure the values you selected are saved to the CMOS RAM. The CMOS RAM is sustained by an onboard backup battery and stays on even when the PC is turned off. When you select this option, a confirmation window appears. Select [Yes] to save changes and exit.



If you attempt to exit the Setup program without saving your changes, the program prompts you with a message asking if you want to save your changes before exiting. Pressing <Enter> saves the changes while exiting.

Exit Discarding Changes

Select this option only if you do not want to save the changes that you made to the Setup program. If you made changes to fields other than system date, system time, and password, the BIOS asks for a confirmation before exiting.

Load Setup Defaults

This option allows you to load the default values for each of the parameters on the Setup menus. When you select this option or if you press <F5>, a confirmation window appears. Select [Yes] to load default values. Select Exit Saving Changes or make other changes before saving the values to the non-volatile RAM.

Discard Changes

This option allows you to discard the selections you made and restore the previously saved values. After selecting this option, a confirmation appears. Select [Yes] to discard any changes and load the previously saved values.

Save Changes

This option saves your selections without exiting the Setup program. You can then return to other menus and make further changes. After you select this option, a confirmation window appears. Select [Yes] to save any changes to the non-volatile RAM.

Chapter 3

This chapter helps you power up your system and install drivers and utilities that came with the support CD.

Starting Up

3.1 Install an operating system

The A7V600-X motherboard supports Windows ME/2000/XP operating systems (OS). Always install the latest OS version and corresponding updates so you can maximize the features of your hardware.



Because motherboard settings and hardware options vary, use the setup procedures presented in this chapter for general reference only. Refer to your OS documentation for more information.

3.2 Support CD information

The support CD that came with the motherboard contains useful software and several utility drivers that enhance the motherboard features.



The contents of the support CD are subject to change at any time without notice. Visit the ASUS website for updates.

3.2.1 Running the support CD

To begin using the support CD, simply insert the CD into your CD-ROM drive. The CD automatically displays the **Drivers** menu if Autorun is enabled in your computer.

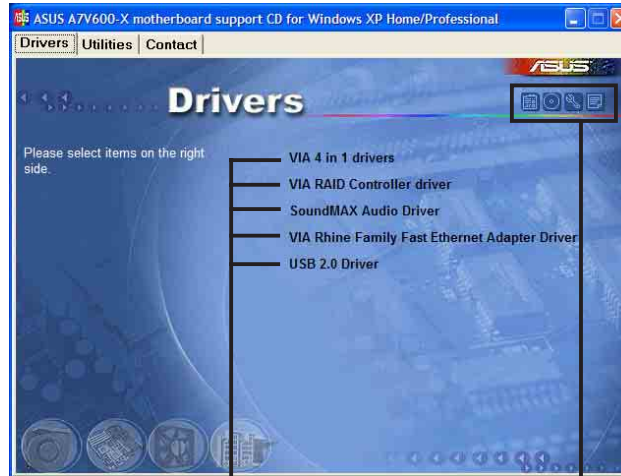

Click an item to install

Click an icon to display more information



If **Autorun** is NOT enabled in your computer, browse the contents of the support CD to locate the file **ASSETUP.EXE** from the **BIN** folder. Double-click the **ASSETUP.EXE** to run the CD.

3.2.2 Drivers menu

VIA 4 in 1 drivers

This item installs the following drivers:

- VIA Registry (INF) driver
- VIA AGP VxD driver
- VIA ATAPI vendor support driver
- VIA PCI IRQ Miniport driver.

VIA RAID Controller driver

This item installs the VIA RAID controller drivers.

SoundMAX Audio Driver

This item installs the ADI 1888 AC'97 compliant audio controller and application.

VIA Rhine Family Fast Ethernet Adapter Driver

This item installs the VIA Fast Ethernet LAN drivers for 10/100Mbps LAN solution.

USB 2.0 Driver

This item installs the USB 2.0 driver to upgrade your USB 1.1 ports to USB 2.0.



Some menu items appear only to specific operating system versions.

3.2.3 Utilities menu

The Utilities menu shows the applications and other software that the motherboard supports.

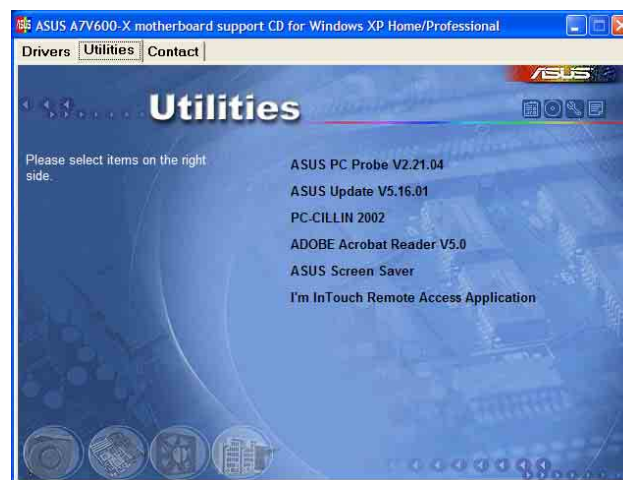

ASUS PC Probe

Install utility that can monitor Fan, Speed, Voltage, and CPU temperature.

ASUS Update

Installs utility to download and update motherboard BIOS & drivers.

PC-cillin 2002

This item installs the PC-cillin 2002 V9.02 anti-virus software.

ADOBE Acrobat Reader V5.0

This installs software for viewing files in Portable Document Format (PDF).

ASUS Screen Saver

This item installs the ASUS screen saver.

I'm InTouch Remote Access Application

This item installs the I'm InTouch Remote Access application that allow users to remotely access files or control some hardware from their PC at home or in the office.

3.2.4 ASUS Contact Information

Clicking the ASUS Contact Information tab displays as stated. You may also find this information on page viii of this user guide.

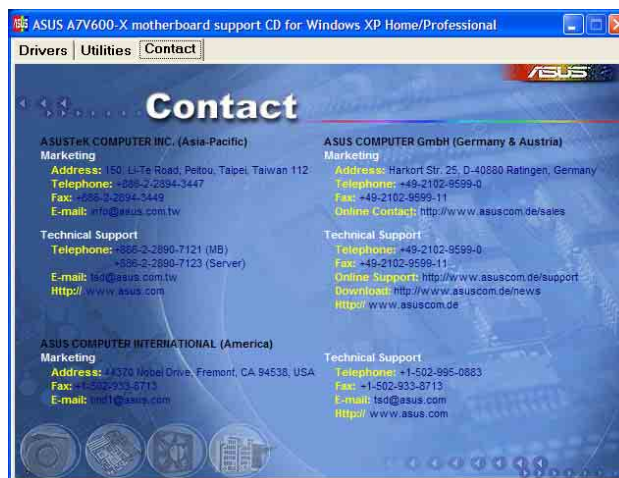

3.3 ASUS Instant Music Lite

The motherboard is equipped with a BIOS-based audio playback feature called **Instant Music Lite**. This feature is supported by the onboard audio AC'97 CODEC, and requires an optical drive (CD-ROM, DVD-ROM, or CD-RW).

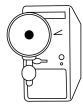

1. Instant Music Lite only supports CDs in audio format.
2. Instant Music Lite does not work if you installed and enabled an add-on sound card.
3. Instant Music Lite only supports PS/2 keyboard.

To enable ASUS Instant Music Lite:

1. Connect the analog audio cable from the optical drive (CD-ROM, DVD-ROM, or CD-RW drive) to the 4-pin CD-In connector (labeled CD1) on the motherboard. See section “1.12 Connectors” for the connector location.



Make sure to connect the CD-ROM audio cable. Otherwise, you cannot control the audio volume using the Instant Music Lite function keys.

2. Turn on the system and enter BIOS by pressing the **Delete** key during the Power On Self-Tests (POST).
3. In the **Advanced Configuration** menu, select the item **Instant Music** and set it to **Enabled**. See section “2.4 Advanced Menu” in the user guide.
4. Highlight the **Instant Music CDRM** item and press Enter to display the CD-ROM options. Select the CD-ROM drive that you wish to use for this feature. See section “2.4 Advanced Menu” in the user guide.



If you have only one optical drive (either CD-ROM, DVD-ROM, or CD-RW) installed in the system, you don't have to set Instant Music CDRM item. BIOS automatically detects and displays the installed drive type.

5. Save your changes and exit BIOS Setup.



1. The Scroll Lock LED is fixed to ON after enabling Instant Music.
2. The Caps Lock LED is turns ON when you pause the CD playback.
3. When set to Instant Music Lite mode, the system wake-up features (LAN, keyboard, mouse, USB) are deactivated. In this case, power up the system using the power switch.
4. If the system lost connection or did not detect any optical drive, the Instant Music Lite feature turns OFF (disabled) automatically. A “beep” indicates this condition.

To use ASUS Instant Music Lite:

1. Ensure that the power cord is plugged to a grounded power source, so that the system has a standby power.
2. Use either one of the two sets of special function keys on your keyboard to play audio CDs. These keys only function as indicated if you enabled the Instant Music Lite in BIOS.

Instant Music function keys (Set 1)

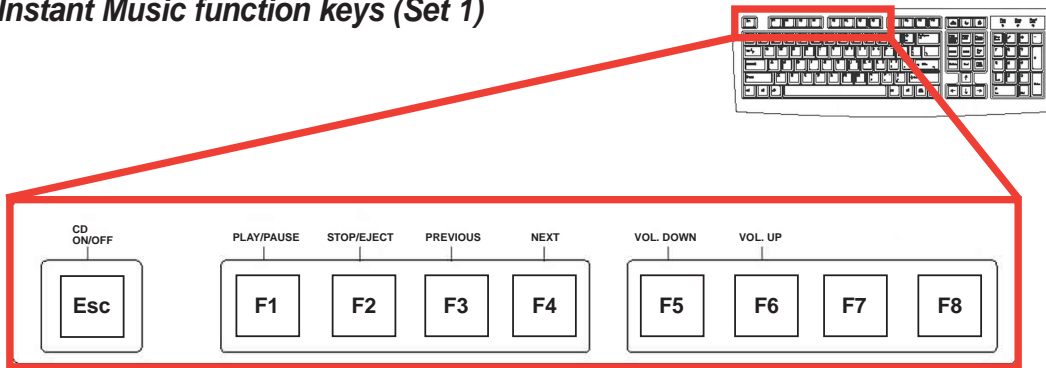

Instant Music function keys (Set 2)

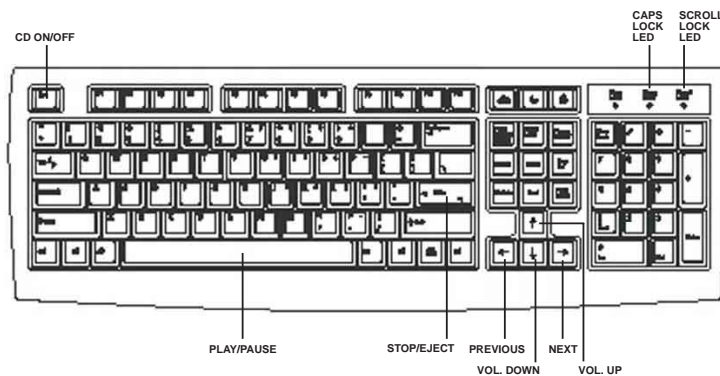

3. Connect speakers or a headphone to the Line Out (lime colored) port on the rear panel for audio output. You may also connect a headphone to the headphone jack on the CD-ROM drive front panel.
4. Place an audio CD on the drive.
5. Press **Esc** to turn ON Instant Music Lite.
6. Press **F1** or the **Space Bar** to play the first track on the CD.



If there is no CD on the drive and you press F1 or Space Bar, the drive tray ejects.

7. Refer to the Instant Music function key definitions on the previous page to select other tracks or control the volume.
8. Press **F2** or **Enter** *once* to stop playing the CD.
Press **F2** or **Enter** *one more time* to eject the CD.

3.4 RAID 0 / RAID 1 / JBOD configurations

The motherboard includes a high performance IDE RAID controller integrated in the VIA® VT8237 southbridge chipset. It supports RAID 0, RAID 1 and JBOD with two independent Serial ATA channels.

RAID 0 (called *data striping*) optimizes two identical hard disk drives to read and write data in parallel, interleaved stacks. Two hard disks perform the same work as a single drive but at a sustained data transfer rate, double that of a single disk alone, thus improving data access and storage.

RAID 1 (called *data mirroring*) copies and maintains an identical image of data from one drive to a second drive. If one drive fails, the disk array management software directs all applications to the surviving drive as it contains a complete copy of the data in the other drive. This RAID configuration provides data protection and increases fault tolerance to the entire system.

JBOD (for “*just a bunch of disks*” or sometimes “*just a bunch of drives*”) is officially termed as “*spanning*”. This is used to refer to a computer’s hard disks that haven’t been configured according the RAID system to increase fault tolerance and improved data access performance. This RAID system stores the same data redundantly on multiple drives by combining the drives into one larger logical drive.

3.4.1 Install the Serial ATA (SATA) hard disks

The VIA® VT8237 southbridge chipset supports Serial ATA hard disk drives. For optimal performance, install identical drives of the same model and capacity when creating a RAID set.

- If you are creating a **RAID 0 (striping)** array for performance, use two new drives.
- If you are creating a **RAID 1 (mirroring)** array for protection, you can use two new drives or use an existing drive and a new drive (the new drive must be of the same size or larger than the existing drive). If you use two drives of different sizes, the smaller capacity hard disk will be the base storage size. For example, one hard disk has an 80GB storage capacity and the other hard disk has 60GB storage capacity, the maximum storage capacity for the RAID 1 set is 60GB.

Follow these steps to install the SATA hard disks for RAID configuration.

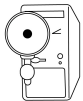

-
- Before setting up your new RAID array, verify the status of your hard disks. Make sure the Master/Slave jumpers are configured properly.
 - Both the data and power SATA cables are new cables. You cannot use older 40-pin 80-conductor IDE or regular IDE power cables with Serial ATA drives. Installing Serial ATA (SATA) hard disks require the use of new Serial ATA cable (4-conductor) which supports the Serial ATA protocol and a Serial ATA power cable.
 - Either end of the Serial ATA data cable can be connected to the SATA hard disk or the SATA connector on the motherboard.
-

1. Install the Serial ATA hard disks into the drive bays.
2. Connect one end of the Serial ATA cable to the motherboard's primary Serial ATA connector (SATA1).
3. Connect the other end of Serial ATA cable to the master Serial ATA hard disk.
4. Connect one end of the second Serial ATA cable to the motherboard's secondary Serial ATA connector (SATA2).
5. Connect the other end of Serial ATA cable to the secondary Serial ATA hard disk.
6. Connect the Serial ATA power cable to the power connector on each drive.
7. Proceed to section 5.4.2 "Entering VIA® Tech RAID BIOS Utility" for the next procedure.

3.4.2 Entering VIA® Tech RAID BIOS Utility

1. Boot-up your computer.
2. During POST, press **<Tab>** to enter VIA RAID configuration utility. The following menu options will appear.

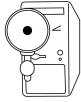

The RAID BIOS information on the setup screen shown is for reference only. What you see on your screen may not be exactly the same as shown.

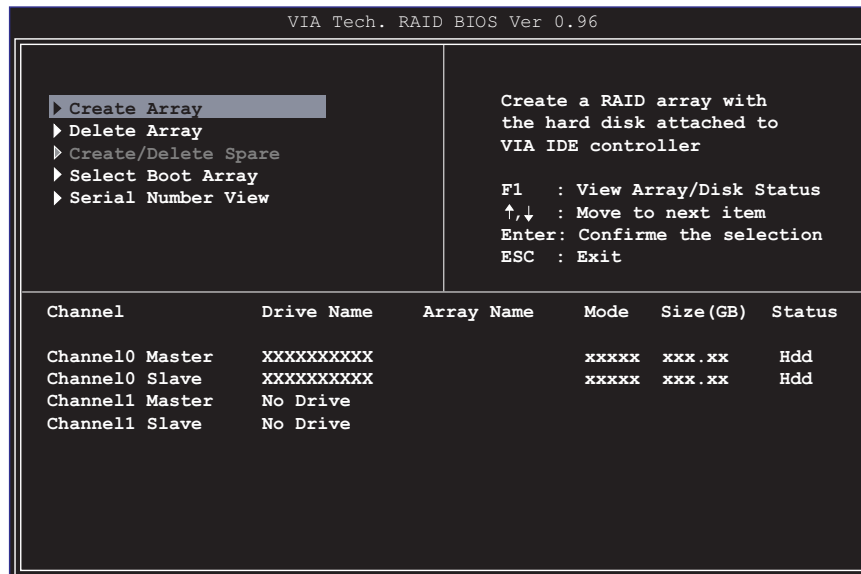

On the upper-right side of the screen is the message and legend box. The keys on the legend box allows you to navigate through the setup menu options. The message describes the function of each menu item. The following lists the keys found in the legend box with their corresponding functions.

F1 : View Array/Disk Status
↑, ↓ : Move to the next item
Enter : Confirm the selection
ESC : Exit

3.4.3 Create Array

1. In the VIA RAID BIOS utility main menu, select **Create Array** then press the <Enter> key. The main menu items on the upper-left corner of the screen are replaced with create array menu options.

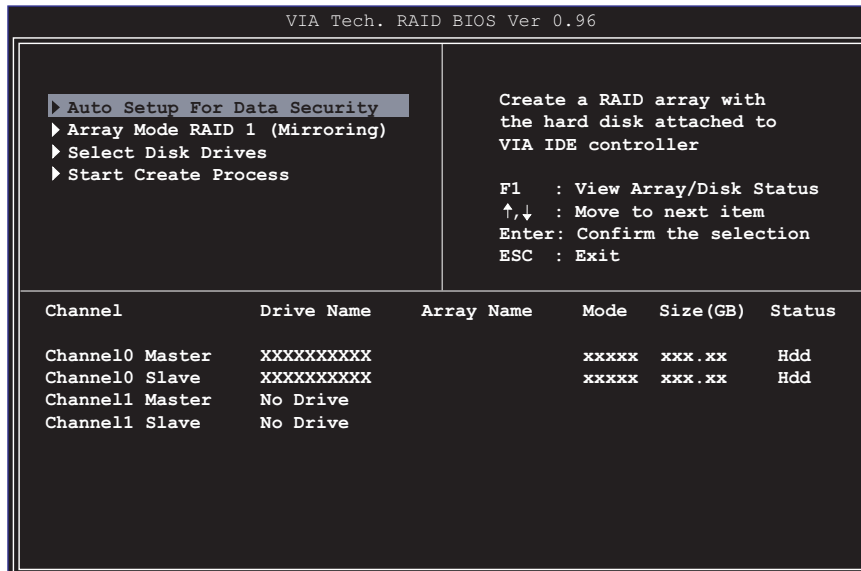

RAID 0 for performance

1. Select the second option item **Array Mode**, then press the <Enter> key. The RAID system setting pop-up menu appears.

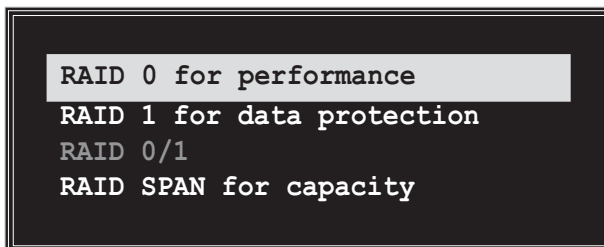

2. Select **RAID 0 for performance** from the menu and press <Enter>. From this point, you may choose to auto-configure the RAID array by selecting **Auto Setup for Performance** or manually configure the RAID array for striped sets. If you want to manually configure the RAID array continue with next step, otherwise, proceed to step #5.
3. Select **Select Disk Drives**, then press <Enter>. Use arrow keys to select disk drive/s, then press <Enter> to mark selected drive. An asterisk is placed before the selected drive.
4. Select **Block Size**, then press <Enter> to set array block size. A list of valid array block sizes are displayed on a pop-up menu.

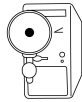
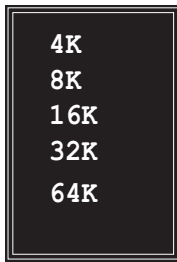

TIP: For server systems, it is recommended to use a lower array block size. For multimedia computer systems used mainly for audio and video editing, a higher array block size is recommended for optimum performance

Use arrow keys to move selection bar on items and press <Enter> to select.

5. Select **Start Create Process** and press <Enter> to setup hard disk for RAID system. The following confirmation message appears:

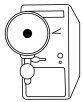

The same confirmation message appears when the **Auto Setup for Performance** option is selected.

The data on the selected disks will be destroyed. Continue? Press Y/N

Press “Y” to confirm or “N” to return to the configuration options.

RAID 1 for data protection

1. Select the second option item **Array Mode**, then press the <Enter> key. The RAID system setting pop-up menu appears.

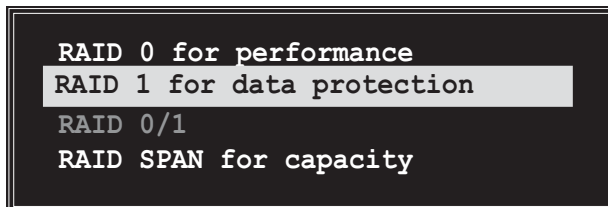

2. Select **RAID 1 for data protection** from the menu and press <Enter>. Select next task from pop-up menu. The task **Create only** creates the mirrored set without creating a backup. **Create and duplicate** creates both mirrored set and backup.

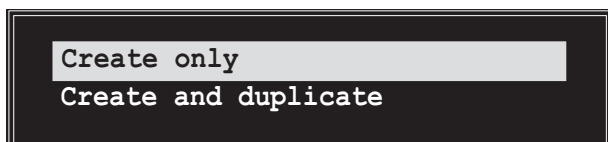

3. Select task and press <Enter>. The screen returns to Create Array menu items. From this point, you may choose to auto-configure the RAID array by selecting **Auto Setup for Data Security** or manually configure the RAID array for mirrored sets. If you want to manually configure the RAID array continue with next step, otherwise, proceed to step #5.

4. Select **Select Disk Drives**, then press <Enter>. Use arrow keys to select disk drive/s, then press <Enter> to mark selected drive. (*An asterisk is placed before a selected drive.*)
5. Select **Start Create Process** and press <Enter> to setup hard disk for RAID system. The following confirmation message appears:

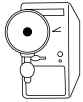

The same confirmation message appears when the **Auto Setup for Data Security** option is selected.

```
The data on the selected disks will
be destroyed. Continue? Press Y/N
```

Press “Y” to confirm or “N” to return to the configuration options.

RAID SPAN for capacity

1. Select the second option item **Array Mode**, then press the <Enter> key. The RAID system setting pop-up menu appears.

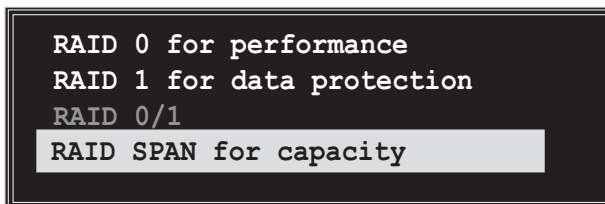

2. Select **RAID SPAN for capacity** from the menu and press <Enter>. From this point, you may choose to auto-configure the RAID array by selecting **Auto Setup for Capacity** or manually configure the RAID array for spanned sets. If you want to manually configure the RAID array continue with next step. Screen reference on Auto Setup for Capacity can be found in step #4
3. Select **Select Disk Drives**, then press <Enter>. Use arrow keys to select disk drive/s, then press <Enter> to mark selected drive. (*An asterisk is placed before a selected drive.*)

4. Select **Start Create Process** and press <Enter> to setup hard disk for RAID system. The following confirmation message appears:

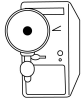

The same confirmation message appears when the **Auto Setup for Capacity** option is selected.

The data on the selected disks will be destroyed. Continue? Press Y/N

Press “Y” to confirm or “N” to return to the configuration options.

3.4.4 Delete Array

1. In the VIA RAID BIOS utility main menu, select **Delete Array** then press the <Enter> key. The focus is directed to the list of channel used for IDE RAID arrays.
2. Press the <Enter> key to select a RAID array to delete. The following confirmation message appears.

The selected array will be destroyed. Are you sure? Continue? Press Y/N

Press “Y” to confirm or “N” to return to the configuration options.

3.4.5 Select Boot Array

1. In the VIA RAID BIOS utility main menu, select **Select Boot Array** then press the <Enter> key. The focus is directed to the list of channel used for IDE RAID arrays.
2. Press the <Enter> key to select a RAID array for boot. The **Status** of the selected array will change to Boot. Press <ESC> key to go return to menu items. Follow the same procedure to deselect the the boot array.

Channel	Drive Name	Array Name	Mode	Size (GB)	Status
[] Channel0 Master	XXXXXXXXXX		xxxxxxx	xxx.xx	Hdd
[] Channel0 Slave	XXXXXXXXXX		xxxxxxx	xxx.xx	Hdd
Channel1 Master	No Drive				
Channel1 Slave	No Drive				

3.4.6 Serial Number View

1. In the VIA RAID BIOS utility main menu, select **Serial Number View** then press the <Enter> key. The focus is directed to the list of channel used for IDE RAID arrays. Move the selection bar on each item and the serial number is displayed at the bottom of the screen. This option is useful for identifying same model disks.

