



A7N8X

Series

User Manual

Motherboard

Product Name: **A7N8X**
Manual Revision: **Revised Edition V2 E1170**
Release Date: **November 2002**

Copyright © 2002 ASUSTeK COMPUTER INC. All Rights Reserved.

No part of this manual, including the products and software described in it, may be reproduced, transmitted, transcribed, stored in a retrieval system, or translated into any language in any form or by any means, except documentation kept by the purchaser for backup purposes, without the express written permission of ASUSTeK COMPUTER INC. ("ASUS").

Product warranty or service will not be extended if: (1) the product is repaired, modified or altered, unless such repair, modification or alteration is authorized in writing by ASUS; or (2) the serial number of the product is defaced or missing.

Products and corporate names appearing in this manual may or may not be registered trademarks or copyrights of their respective companies, and are used only for identification or explanation and to the owners' benefit, without intent to infringe.

The product name and revision number are both printed on the product itself. Manual revisions are released for each product design represented by the digit before and after the period of the manual revision number. Manual updates are represented by the third digit in the manual revision number.

For previous or updated manuals, BIOS, drivers, or product release information, contact ASUS at: <http://www.asus.com> or through any of the means indicated on the following page.

ASUS PROVIDES THIS MANUAL "AS IS" WITHOUT WARRANTY OF ANY KIND, EITHER EXPRESS OR IMPLIED, INCLUDING BUT NOT LIMITED TO THE IMPLIED WARRANTIES OR CONDITIONS OF MERCHANTABILITY OR FITNESS FOR A PARTICULAR PURPOSE. IN NO EVENT SHALL ASUS, ITS DIRECTORS, OFFICERS, EMPLOYEES OR AGENTS BE LIABLE FOR ANY INDIRECT, SPECIAL, INCIDENTAL, OR CONSEQUENTIAL DAMAGES (INCLUDING DAMAGES FOR LOSS OF PROFITS, LOSS OF BUSINESS, LOSS OF USE OR DATA, INTERRUPTION OF BUSINESS AND THE LIKE), EVEN IF ASUS HAS BEEN ADVISED OF THE POSSIBILITY OF SUCH DAMAGES ARISING FROM ANY DEFECT OR ERROR IN THIS MANUAL OR PRODUCT.

SPECIFICATIONS AND INFORMATION CONTAINED IN THIS MANUAL ARE FURNISHED FOR INFORMATIONAL USE ONLY, AND ARE SUBJECT TO CHANGE AT ANY TIME WITHOUT NOTICE, AND SHOULD NOT BE CONSTRUED AS A COMMITMENT BY ASUS. ASUS ASSUMES NO RESPONSIBILITY OR LIABILITY FOR ANY ERRORS OR INACCURACIES THAT MAY APPEAR IN THIS MANUAL, INCLUDING THE PRODUCTS AND SOFTWARE DESCRIBED IN IT.

About this guide

This user manual contains complete information for installing the ASUS A7N8X motherboard.

How this guide is organized

- **Chapter 1: Product introduction.** A summary of product features and special attributes of new technologies.
- **Chapter 2: Hardware information.** A list of hardware setup procedures and descriptions of all jumpers and connectors on the motherboard.
- **Chapter 3: Powering up.** Describes the power up sequence with information on BIOS beep codes.
- **Chapter 4: BIOS setup.** How to change system settings using onboard BIOS firmware. Detailed descriptions of the BIOS parameters are supplied.
- **Chapter 5: Software support.** A summary of contents on the motherboard support CD ROM.
- **Appendix and Glossary.** Optional components and technical definitions.
- **Index**

Conventions used in this guide

To make sure that you perform set-up tasks properly, take note of the following symbols used throughout this manual.



WARNING! Information to prevent injury to yourself.



CAUTION! Information to prevent damage to the components.



IMPORTANT! Information that you **MUST** follow to complete a task.



NOTE! Tips and helpful information.

References

1. NVIDIA nForce Audio Panel Manual
2. Silicon Image Sil 3112 SATALink Controller Driver Installation
3. SATARAID Software User's Manual

Contents

About this guide	iii
How this guide is organized	iii
Conventions used in this guide	iii
Safety information	vi
FCC/CDC statements	vii
ASUS contact information	viii
A7N8X Specifications summary	ix
Chapter 1: Product introduction	1
Welcome!	1
1.1 Package contents	1
1.2 Core Specifications	2
1.3 ASUS Special Features	3
1.4 Motherboard Components	4
1.5 Special Features	6
Chapter 2: Hardware information	7
2.1 Motherboard installation	7
2.2 Layout contents	9
2.3 Before you proceed	10
2.4 Central Processing Unit (CPU)	11
2.5 System memory	13
2.6 Expansion slots	15
2.7 Jumpers	19
2.8 Connectors	22
Chapter 3: Powering up	35
3.1 Starting up for the first time	35
3.2 Vocal POST Messages	36
3.3 Powering-off the computer	38
Chapter 4: BIOS	39
4.1 Managing and updating your BIOS	39
4.2 BIOS Setup program	42
4.3 Main Menu	46
4.4 Advanced Menu	51

Contents

4.4.1	Advanced BIOS Features	51
4.4.2	Advanced Chipset Features	55
4.4.3	Integrated Peripherals	58
4.4.4	Power Management Setup	61
4.4.5	PnP / PCI Configurations	63
4.5	Security Menu	65
4.6	Hardware Monitor Menu	66
4.7	Exit Menu	68
Chapter 5: Software support		71
5.1	Install an operating system	71
5.2	Support CD information	71
5.3	A7N8X Motherboard Support CD	72
5.3.1	Installation Procedure	72
5.3.2	Installation of PCI Drivers: Win98	73
5.4	ASUS PC Probe	75
5.5	ASUS Live Update	80
5.6	3Deep Color Tuner	81
5.7	NVIDIA nForce Control Panel	83
5.8	Winbond Editor	88
5.9	RAID 0/1 Configurations	91
Chapter 6: Appendix		95
6.1	Glossary	95
Index		99

Safety information

Electrical safety

- To prevent electrical shock hazard, disconnect the power cable from the electrical outlet before relocating the system.
- When adding or removing devices to or from the system, ensure that the power cables for the devices are unplugged before the signal cables are connected. Disconnect all power cables from the existing system before you add a device.
- Before connecting or removing signal cables from the motherboard, ensure that all power cables are unplugged.
- Seek professional assistance before using an adapter or extension cord. These devices could interrupt the grounding circuit.
- Make sure that your power supply is set to the voltage available in your area.
- If the power supply is broken, contact a qualified service technician or your retailer.

Operational safety

- Before installing the motherboard and adding new devices, carefully read all the manuals that came with the package.
- Before use ensure all cables are correctly connected and the power cables are not damaged. If you detect any damage, contact the dealer immediately.
- To avoid short circuits, keep paper clips, screws, and staples away from connectors, slots, sockets and circuitry.
- Avoid dust, humidity, and temperature extremes. Do not place the product in any area where it may become wet.
- Mount the motherboard inside a standard PC enclosure.
- If you encounter technical problems with the product, contact a qualified service technician or the dealer.

FCC/CDC statements

Federal Communications Commission Statement

This device complies with FCC Rules Part 15. Operation is subject to the following two conditions:

- This device may not cause harmful interference, and
- This device must accept any interference received including interference that may cause undesired operation.

This equipment has been tested and found to comply with the limits for a Class B digital device, pursuant to Part 15 of the FCC Rules. These limits are designed to provide reasonable protection against harmful interference in a residential installation. This equipment generates, uses and can radiate radio frequency energy and, if not installed and used in accordance with manufacturer's instructions, may cause harmful interference to radio communications. However, there is no guarantee that interference will not occur in a particular installation. If this equipment does cause harmful interference to radio or television reception, which can be determined by turning the equipment off and on, the user is encouraged to try to correct the interference by one or more of the following measures:

- Reorient or relocate the receiving antenna.
- Increase the separation between the equipment and receiver.
- Connect the equipment to an outlet on a circuit different from that to which the receiver is connected.
- Consult the dealer or an experienced radio/TV technician for help.



The use of shielded cables for connection of the monitor to the graphics card is required to assure compliance with FCC regulations. Changes or modifications to this unit not expressly approved by the party responsible for compliance could void the user's authority to operate this equipment.

Canadian Department of Communications Statement

This digital apparatus does not exceed the Class B limits for radio noise emissions from digital apparatus set out in the Radio Interference Regulations of the Canadian Department of Communications.

This class B digital apparatus complies with Canadian ICES-003.

ASUS contact information

ASUSTeK COMPUTER INC. (Asia-Pacific)

Address: 150 Li-Te Road, Peitou, Taipei, Taiwan 112
General Tel: +886-2-2894-3447
General Fax: +886-2-2894-3449
General Email: info@asus.com.tw

Technical Support

MB/Others (Tel): +886-2-2890-7121 (English)
Notebook (Tel): +886-2-2890-7122 (English)
Desktop/Server (Tel): +886-2-2890-7123 (English)
Support Fax: +886-2-2890-7698
Support Email: tsd@asus.com.tw
Web Site: www.asus.com.tw
Newsgroup: cscnews.asus.com.tw

ASUS COMPUTER INTERNATIONAL (America)

Address: 6737 Mowry Avenue, Mowry Business Center,
Building 2, Newark, CA 94560, USA
General Fax: +1-510-608-4555
General Email: tmd1@asus.com

Technical Support

Support Fax: +1-510-608-4555
General Support: +1-502-933-8713
Web Site: www.asus.com
Support Email: tsd@asus.com

ASUS COMPUTER GmbH (Germany & Austria)

Address: Harkortstr. 25, 40880 Ratingen, BRD, Germany
General Fax: +49-2102-442066
General Email: sales@asuscom.de (for marketing requests only)

Technical Support

Support Hotline: MB/Others: +49-2102-9599-0
Notebook (Tel): +49-2102-9599-10
Support Fax: +49-2102-9599-11
Support (Email): www.asuscom.de/de/support (for online support)
Web Site: www.asuscom.de

A7N8X specifications summary

CPU	Socket A for AMD Duron™/Athlon™/Athlon™ XP 2800+ or higher 333 MHz FSB Support
Chipset	Northbridge: NVIDIA® nForce2 SPP Southbridge: NVIDIA® nForce2 MCP-T (Deluxe Model)/MCP
Front Side Bus (FSB)	333/266/200Mhz
Memory	3 x 184-pin DDR DIMM Sockets Max. 3 GB unbuffered PC3200/2700/2100/1600 non-ECC DDR RAM memory. Dual-Channel DDR400 support. (Visit ASUS website for latest qualified DDR400 module list.)
Expansion slots	5 x PCI 1 x AGP Pro/8X (1.5V only)
IDE	2 x UltraDMA 133/100/66/33
Serial ATA (optional)	Silicon Image Sil 3112A Controller with 2 Ports (Supports RAID 0/1) (Deluxe model only)
Audio (optional)	Realtek ALC650 6CH with built-in HP amplifier Integrated APU (Audio Processor Unit) (Deluxe model only) SoundStorm™/Dolby® Digital (AC-3) Encoder (Deluxe model only)
LAN (optional)	2 Ports MCP integrated NVIDIA MAC + Realtek 8201BL PHY MCP integrated 3Com MAC + BroadCom AC101L PHY (Deluxe model only)
1394 (optional)	2 Ports MCP-T integrated IEEE 1394a + Realtek PHY 8801B (Deluxe model only)
Special Features	ASUS Q-Fan Technology ASUS POST Reporter (Deluxe model only) ASUS C.O.P. (CPU Overheating Protection) Power Loss Restart CPU Throttle Support S/PDIF in/out (optional)
Back Panel I/O Ports	1 x Parallel 1 x Serial 1 x PS/2 Keyboard 1 x PS/2 Mouse 1 x S/PDIF out + 1 x Surround L/R audio jack + 1 x CNTR/LFE audio jack (Deluxe model only) 1 x Audio I/O 2 x RJ-45 Port (3COM RJ-45 port - Deluxe model only) 4 x USB 2.0 (continued on the next page)

A7N8X specifications summary

Internal I/O Connectors	<p>1 x USB 2.0 connector supports additional 2 USB 2.0 ports (optional)</p> <p>Game connector</p> <p>CPU/Power/Chassis FAN connectors</p> <p>20-pin ATX Power connector</p> <p>IDE LED connector, Power LED connector</p> <p>2 x SATA connector (<i>Deluxe model only</i>)</p> <p>2 x 1394 connector (<i>Deluxe model only</i>)</p> <p>WOR, WOL, Chassis Intrusion, SM Bus, SIR</p> <p>Headphone (optional)</p> <p>Front MIC (optional)</p> <p>CD / AUX / Modem audio in</p> <p>Front Panel Audio connector (optional)</p>
BIOS features	4Mb Flash ROM, Award BIOS, TCAV, PnP, DMI2.0, DMI, Green
Industry standard	PCI 2.2, USB 1.1/2.0.
Manageability	DMI 2.0, WOL, WOR, Chassis Intrusion, SM Bus
Support CD contents	<p>Device drivers</p> <p>ASUS PC Probe</p> <p>Trend Micro™ PC-cillin 2002 anti-virus software</p> <p>ASUS LiveUpdate Utility</p>
Accessories	<p>InterVideo WinCinema (optional)</p> <p>User's manual</p> <p>Support CD</p> <p>SATA cable (<i>Deluxe model only</i>)</p> <p>2-port 1394 Bracket (<i>Deluxe model only</i>)</p> <p>1 x UltraDMA 33 cable</p> <p>1 x UltraDMA 133/100/66 cable</p> <p>FDD cable</p> <p>9-pin COM cable</p> <p>2-port USB/Game port bracket (<i>Deluxe model only</i>)</p> <p>I/O shield</p>
Form Factor	ATX form factor: 12 in x 9.6 in

* Specifications are subject to change without notice.

Chapter 1

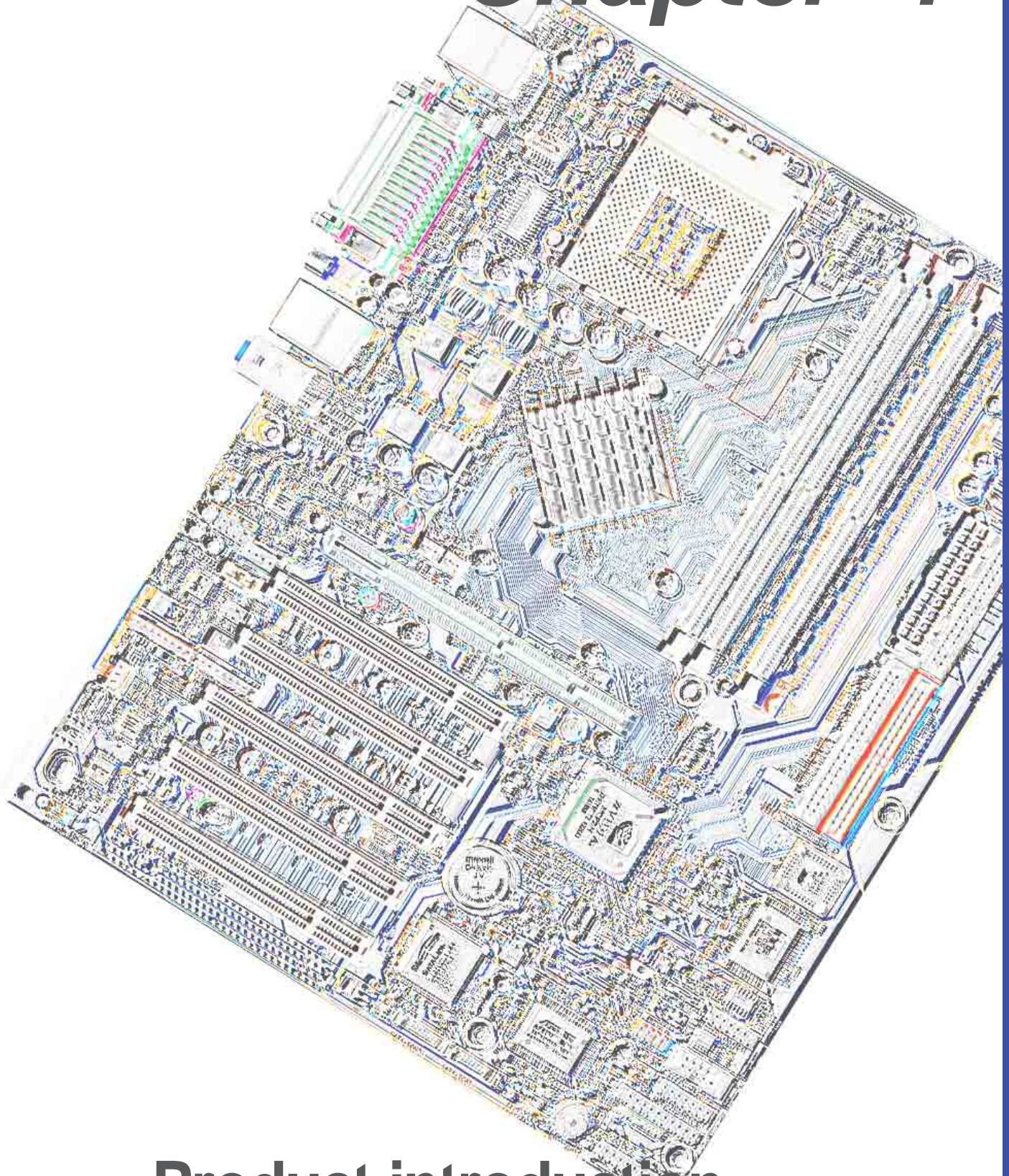

Product introduction

Welcome!

Thank you for buying the ASUS® A7N8X motherboard!

The A7N8X is powered by AMD® Athlon™, Athlon™ XP and Duron™ processors and supplies advanced features to ensure long-lasting, superlative performance. The ASUS® A7N8X motherboard is the prime choice for home PCs and workstations.

- ~ Up to 3 GB of DDR RAM
- ~ New ultra-compact Serial ATA IDE connectors. (optional)
- ~ High-resolution graphics via an AGP 8X slot
- ~ Digital Audio Interface for 3D sound
- ~ Onboard LAN PHY for instant networking (optional)
- ~ Four USB ports plus one header for two more
- ~ UltraDMA133 data rates

The A7N8X is the perfect vehicle to get ahead in the world of power computing!

1.1 Package contents

Check your A7N8X package for the following items.

- ✓ ASUS A7N8X motherboard (ATX form factor: 12 in x 9.6 in)
- ✓ ASUS A7N8X support CD
- ✓ ASUS 2-port USB / Game port module (optional)
- ✓ 40-pin 80 conductor UltraDMA133/100/66/33 IDE ribbon cable
- ✓ Ribbon cable for a 3.5-inch floppy drive
- ✓ COM 2 bracket
- ✓ I/O shield
- ✓ Bag of extra jumper caps
- ✓ User Guide
- ✓ 2 pcs. Serial ATA Cable (optional)
- ✓ 2 pcs. ASUS IEEE 1394 2-port bracket (optional)
- ✓ 2 pcs. ASUS IEEE 1394 cable (optional)



If any of the above items is damaged or missing, contact your retailer.

1.2 Core Specifications

The A7N8X motherboard is designed and assembled according to the highest standards. This ASUS motherboard represents the latest advances and offers users the finest componentry available today...

AMD® Athlon™ / Athlon™ XP and Duron™ Socket A (462) Processor

North Bridge Chipset: the nVidia® nForce2™ SPP North Bridge controller chipset. The controller supports a 64/128bit DDR memory controller and up to 3 GB of 400/333/266/200MHz DDR memory. The 128bit memory controller provides an exceptional 6.4 GB/second system memory bandwidth.

South Bridge Chipset: Features the brand new nVidia® nForce2™ MCP-T/MCP integrated peripheral South Bridge controller operates at 800MB/sec to communicate with the North Bridge for maximum bandwidth required for PCI, USB and support for Fast Ethernet devices. The chipset has an integrated APU (Audio Processing Unit) for Dolby™ digital encoding (*optional*). The controller supports standard UltraDMA133/100/66/33 for burst mode data transfer rates of up to 133MB/sec. Separate data paths for each IDE channel are built-in for up to two IDE devices. The controller supports 2 IEEE 1394 ports (*optional*), six USB ports, two LAN ports (*optional*), and is PCI rev2.2 compliant. The MCP-T/MCP supplies an LPC 1.0 interface along with AT legacy functions, a clock synthesizer and meets ACPI 1.0 and PCI Power Management 1.1 specifications.

PC3200 / PC2700 DDR Support: Equipped with three Double Data Rate Dual Inline Memory Module (DDR DIMM) sockets to support up to 3GB of DDR DRAM, the newest memory standard with the highest bandwidth and lowest latency currently available. This new memory technology supplies data transfer rates up to 6.4 GB/s for 400MHz DDR SDRAM and 5.4GB/s for 333MHz DDR SDRAM.

UltraDMA133/100 Support: Comes with an onboard PCI Bus Master IDE controller with two connectors that support four IDE devices on two channels. Supports UltraDMA133/100/66/33, PIO Modes 3 & 4, Bus Master IDE DMA Mode 2, and Enhanced IDE devices, such as DVD-ROM, CD-ROM, CD-R/RW, LS-120, and Tape Backup drives.

Multi-I/O Chipset: ITE IT8708 offers support for a variety of I/O functions. Provides two high-speed UART compatible serial ports and one parallel port with EPP and ECP capabilities. UART2 can also be directed from COM2 to the Infrared Module for wireless connections. The Super I/O controller supports a floppy disk drive, PS/2 keyboard, and PS/2 mouse.

Connections: Parallel Port, PS/2 mouse Port, PS/2 keyboard, four USB ports, two LAN ports (*optional*), Surround L/R audio jack (*optional*), CNTR/LFE audio jack (*optional*), COM port, Microphone, Line In Jack, Line Out Jack, S/PDIF_OUT (*optional*), ATX power.

Expansion: One AGP Pro 8X, a USB header, two serial ATA IDE connectors (*optional*), two 1394 connectors (*optional*), COM port header, five PCI slots, S/PDIF digital audio connector (*optional*), front audio panel connector, game port header.

1.3 ASUS Special Features

ASUS POST Reporter™  (*optional*)

A7N8X offers the ASUS POST Reporter™ to provide friendly voice messages and alerts during the Power-On Self-Test (POST). Through an added external speaker, messages inform you of system boot status and causes of boot errors. Bundled *Winbond™ Voice Editor* software helps you customize voice messages, and offers multi-language support.

ASUS Q-Fan Technology 

The ASUS Q-Fan technology smartly adjusts the fan speeds according to the system loading to ensure quiet, cool, and efficient operation.

C.O.P. (CPU Overheating Protection): 

With AMD® Athlon XP™ installed, the motherboard offers automatic CPU Overheating Protection to prolong the life of the entire system. If the CPU temperature exceeds the set criteria, the PC shuts down automatically.

1.4 Motherboard Components

Before installing the A7N8X motherboard, take time to familiarize yourself with its configuration:

	Location
Processor Support	Socket A for AMD® Athlon™ and Duron™ Processors 1
Chipsets	nVidia® nForce2™ SPP North Bridge 2
	4Mbit Programmable Flash EEPROM 7
	nVidia® nForce2™ MCP-T/MCP South Bridge 8
	Multi-I/O controller 9
	Serial ATA Controller 18
	1394 PHY Realtek 8801B 22
Main Memory	Maximum 3GB support
	3 DDR DIMM Sockets 3
Expansion Slots	5 PCI Slots 20
	1 Accelerated Graphics Port (AGP) Pro Slot 31
System I/O	1 Floppy Disk Drive Connector 5
	2 IDE Connectors (UltraDMA133/100/66 Support) 6
	1 COM2 Header 10
	1 Gameport Connector 11
	1 Infrared Connector 12
	1 Panel Connector 13
	1 SM Bus Connector 14
	USB Headers (Ports 5/6) 15
	Serial ATA Headers 17
	Modem Connector 21
	IEEE 1394 Headers 23
	S/PDIF Connector 24
	1 PS/2 Mouse Connector (green) 32
	1 PS/2 Keyboard Connector (purple) 45
	RJ45 Connector (3COM LAN Controller) 33
	RJ45 Connector (NVIDIA LAN Controller) 35
	1 Parallel Port 34
	USB Connectors (Ports 3/4) 44
	USB Connectors (Ports 1/2) 39
	1 Serial Ports (COM1) 43
Hardware Monitoring	System Voltage Monitor (integrated in ASUS ASIC) 16
Special Feature	Onboard LED (Green) 19
	Onboard AGP Warning LED (Red) 29
Network Feature	Realtek 8201BL PHY 28
	BroadCom PHY 30
	3Com LAN 33
	NVIDIA LAN 35
Audio Features	Audio Codec 25
	CD / AUX Audio Connectors 26
	Front Panel Audio Connectors 27
	1 Line In Connector (light blue) 36
	1 Line Out Connector (lime) 37
	1 Microphone Connector (pink) 38
	1 S/PDIF out Connector (yellow) 40
	1 Surround L/R audio Connector (violet) 41
	1 CNTR / LFE Connector (orange) 42
Power	ATX Power Supply Connector 4
Form Factor	ATX

1.4.1 Component Locations

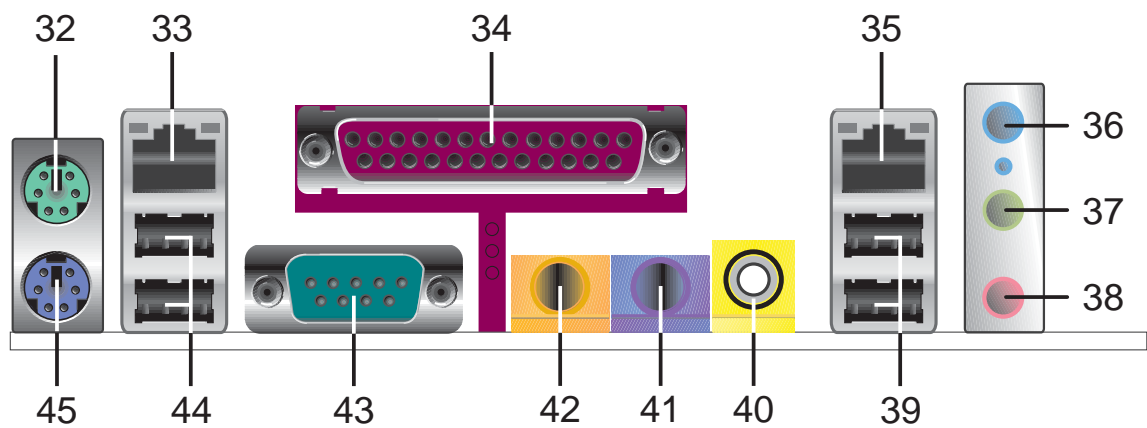
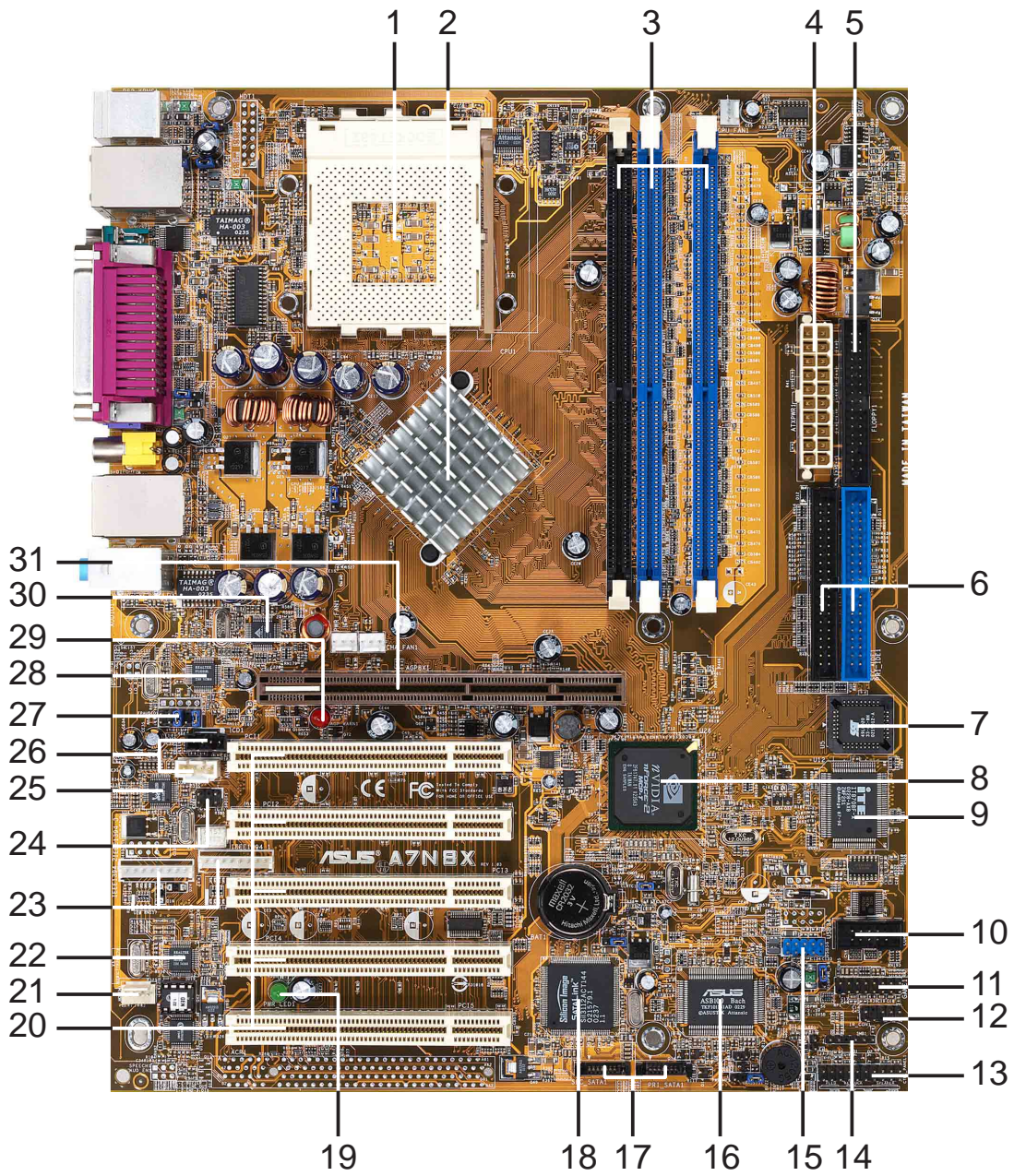

1.5 Special Features

Serial ATA: Silicon Image supplies the Sil-3112A chipset, supporting the ultra-compact 7-pin Serial-ATA IDE device support.

Dual LAN/DualNet: Two south bridge integrated 3COM and Nvidia LAN controllers supply two separate outputs for the network. (optional)

IEEE 1394: Two header support a multiplicity of connections for IEEE 1394 compatible devices. (optional)

Temperature, Fan and Voltage Monitoring: CPU temperature is monitored by ASUS ASIC through a thermal sensor mounted under the CPU. The sensor signals the computer to prevent overheating and damage. The CPU and system fans can be monitored for RPM and failure. System voltage levels are monitored to ensure stable current to critical motherboard components.

ACPI Ready: Advanced Configuration Power Interface (ACPI) provides more Energy Saving Features for operating systems that support OS Direct Power Management (OSPM).

Concurrent PCI: Concurrent PCI allows multiple PCI transfers from PCI master busses to the memory and processor.

Auto Fan Off: The system fans powers off automatically even in sleep mode.

Dual Function Power Button: Push the power button for less than 4 seconds when the system is operating places the system into sleep or soft-off modes; press the power button for more than 4 seconds, and the system enters the soft-off mode regardless of the BIOS setting.

Dolby™ Integrated Audio: MCP-T South bridge integrated Audio Processing Unit (APU) for Dolby™ Digital Encoding. (optional)

Dual Channel DDR 400: The 128-bit TwinBank DDR Memory architecture doubles the DDR 400 (PC3200) bandwidth. System bottlenecks are eliminated with balanced architecture and peak bandwidths up to 6.4 GB/s

Chapter 2

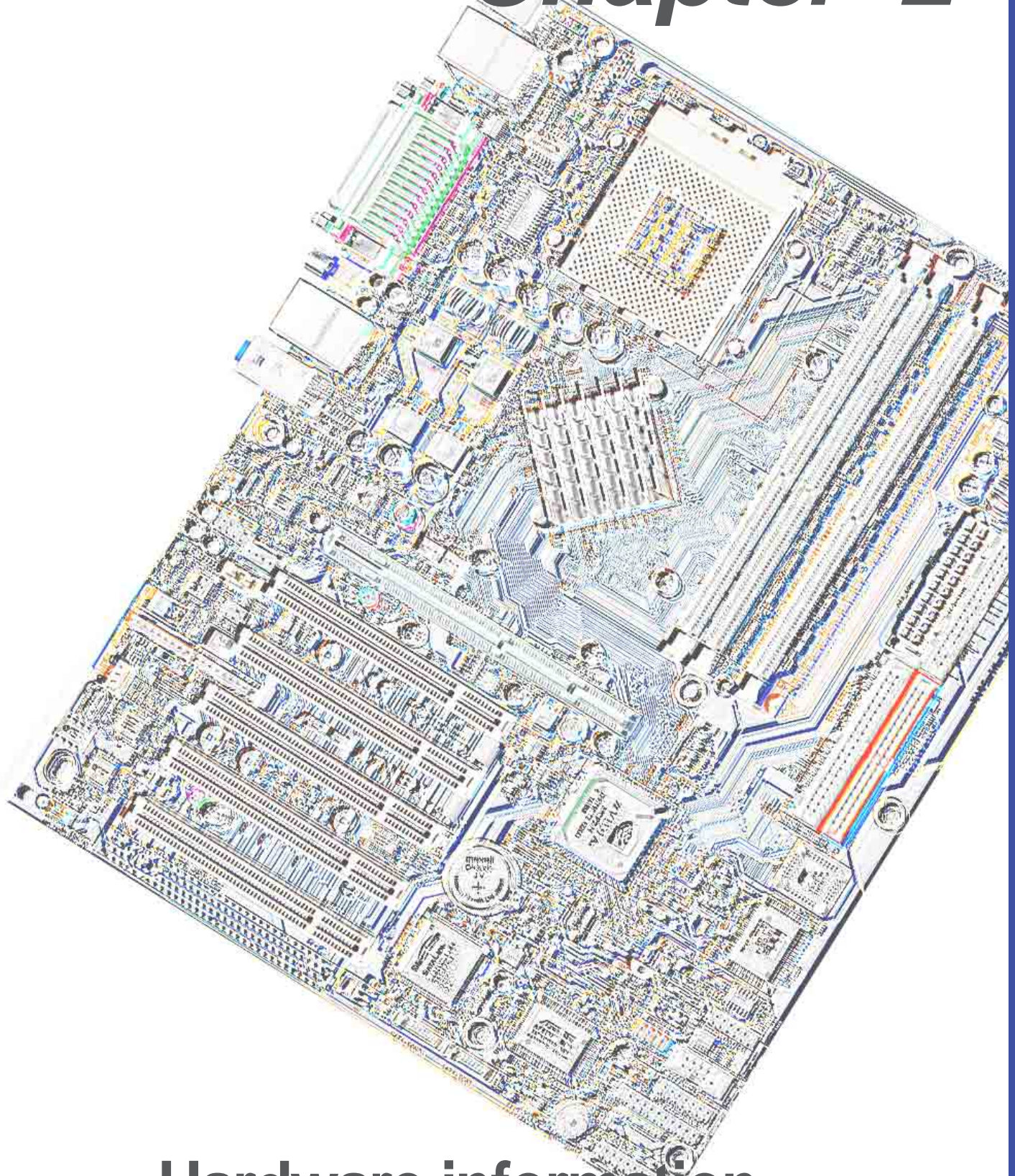

Hardware information

2.1 Motherboard installation

The A7N8X uses the ATX form factor, measuring 24.5 cm (9.6 in.) x 30.5 cm (12.0 in.) - a standard fit for most large chassis.



WARNING! Unplug the power cord before installing the motherboard. Failure to do so may cause you physical injury and damage motherboard components.

2.1.1 Placement direction

When installing the motherboard, take care to orient the chassis correctly: The edge with external ports goes to the rear part of the chassis. Refer to the image below. It may be more convenient to install major cables, the CPU and modular components before fixing the motherboard inside the case frame.

2.1.2 Screw holes

Place nine (9) screws into the holes indicated by circles to secure the motherboard to the chassis.



CAUTION! Do not overtighten the screws! Doing so may damage the motherboard.

Place this side towards
the rear of the chassis

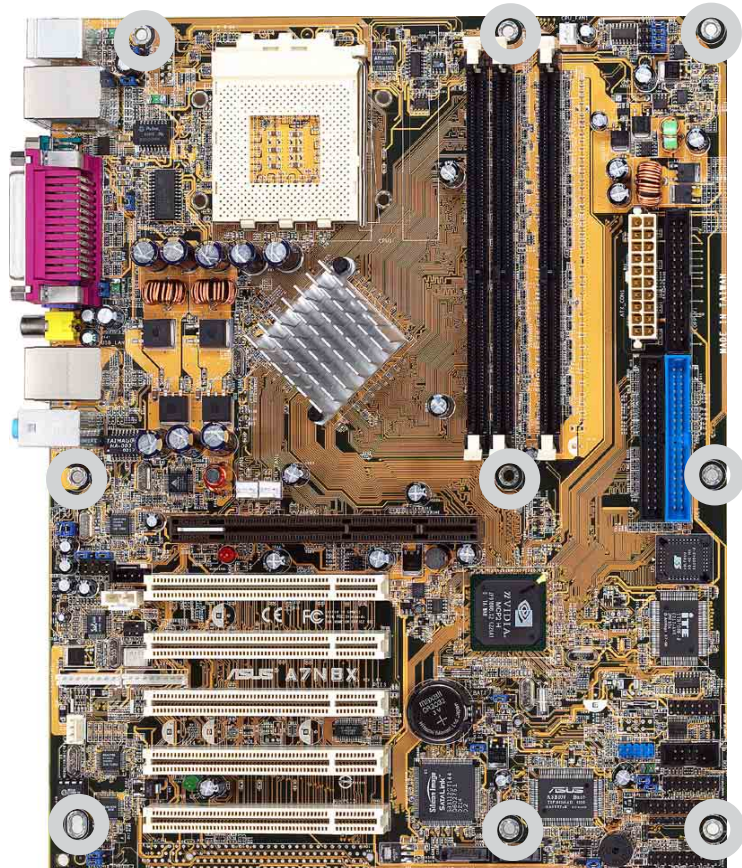

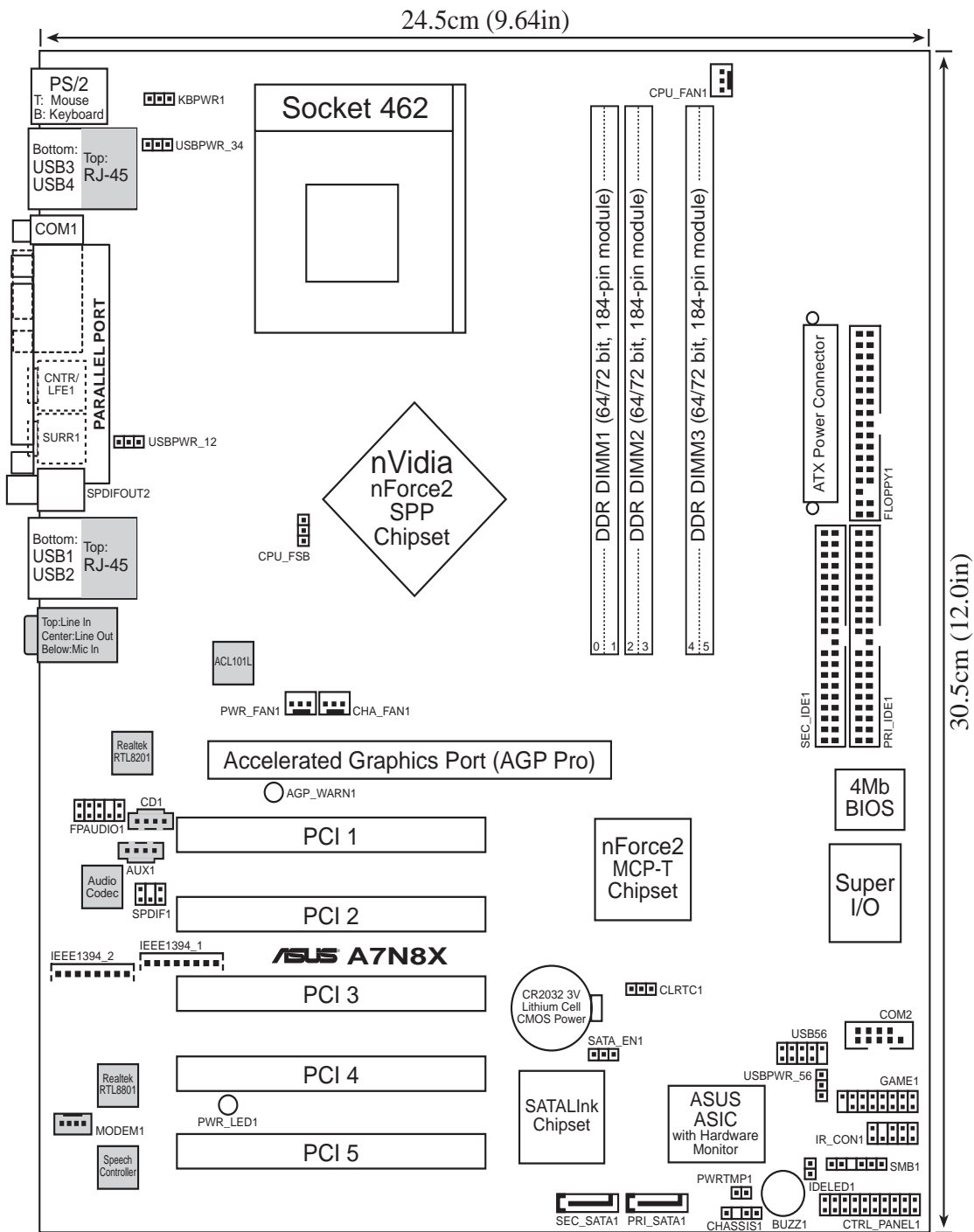

Optional components are grayed in the above motherboard layout.

2.2 Layout contents

CPU, Memory and Expansion Slots

- 1) Socket 462 p. 11 CPU Support
- 2) DIMM 1/2/3 p. 13 System Memory Support
- 3) PCI 1/2/3/4/5 p. 15 32-bit PCI Bus Expansion Slots
- 4) AGP Pro 8x p. 18 Accelerated Graphics Slot

Motherboard Settings (Jumpers)

- 1) SATA_EN1 p. 19 Serial ATA Setting (3 pin)
- 2) KBPWR1 p. 19 Keyboard Wake Up (3 pin)
- 3) USBPWR12, 34, 56 p. 20 USB Device Wake-up (2x3 pin)
- 4) CLRRTC1 p. 21 Clear RTC/CMOS RAM (3 Pin)

Connectors

- 1) PS2KBMS p. 22 PS/2 Mouse Port (6 pin female)
- 2) PS2KBMS p. 22 PS/2 Keyboard Port (6 pin female)
- 3) USB p. 23 Universal Serial Bus Ports 1 & 2 (2 x 4 pin female)
- 4) COM2 p. 23 Serial Port and Header (9 pin male, 10-1 pin male)
- 5) RJ45 p. 24 Fast-Ethernet Port Connector (4 pin) (*Optional*)
- 6) PRINTER p. 24 Parallel Port (25 pin female)
- 7) AUDIO p. 25 Audio Connectors (Six 1/8" jacks)
- 8) IDELED p. 25 IDE Activity LED (Two 40-1 pin)
- 9) FLOPPY p. 26 Floppy Disk Drive Connector (34-1 pin)
- 10) PRIMARY / SEC. IDE p. 26 IDE Connectors (2 x 40-1 pin)
- 11) PRI/SEC_SATA1 p. 27 SATA Serial ATA Connectors (2 x 7-pin)
- 12) IR_CON1 p. 27 ASUS Front Panel Audio Connector (10 pin)
- 13) CPU_FAN1 p. 28 CPU Fan Connector (3 pin)
- 14) 1394HEAD p. 28 IEEE-1394 Header (8-pin) (*Optional*)
- 15) ATXPWR p. 29 Power Supply Connectors (20 pin block)
- 16) SMB p. 29 SMBus Connector (6-1 pin)
- 17) MODEM, CD_IN1, AUX p. 30 Internal Audio Connectors (2 x 4 pin) (*Optional*)
- 18) SPDIF1 p. 30 Digital Audio Interfaces (6 pin) (*Optional*)
- 19) USB_56 p. 31 USB Headers (10-1 pin)
- 20) PWRTMP1 p. 31 Power Supply Thermal Sensor (2-pin) (*Optional*)
- 21) GAME p. 32 Game Connector (16-1 pin)
- 22) CHASSIS1 p. 32 Chassis Open Alarm Lead (4-1 pin)
- 23) FPAUDIO1 p. 33 Front Panel Audio (10-1 pin)
- 24) PWR_LED (Panel) p. 33 System Power LED Lead (3-1 pin)
- 25) KEYLOCK (Panel) p. 33 Keyboard Lock Switch Lead (2 pin)
- 26) SPEAKER (Panel) p. 33 System Warning Speaker Lead (4 pin)
- 27) SMI (Panel) p. 34 System Management Interrupt Lead (2 pin)
- 28) PWR (Panel) p. 34 ATX Power Switch / Soft-Off Switch Lead (2 pin)
- 29) RESET (Panel) p. 34 Reset Switch Lead (2 pin)

2.3 Before you proceed

Take note of the following precautions before you install motherboard components or change any motherboard settings.

CAUTION!



1. Unplug the power cord from the wall socket before touching components.
2. Use a grounded wrist strap or touch a safely grounded object or to a metal object, such as the power supply case, before handling components to avoid damaging them due to static electricity.
3. Hold components by the edges and do not touch the ICs on them.
4. Whenever you uninstall any component, place it on a grounded antistatic pad or in the bag that came with the component.
5. **Before you install or remove any component, ensure that the ATX power supply is switched off or the power cord is detached from the power supply.** Failure to do so may cause severe damage to the motherboard, peripherals, and/or components.



NOTE! When lit, the onboard GREEN LED indicates that the system is ON, in sleep mode or in soft-off mode, not powered OFF. See the illustration below. The RED LED warns if the AGP card is incorrectly installed, or is the wrong type of card for this particular motherboard.

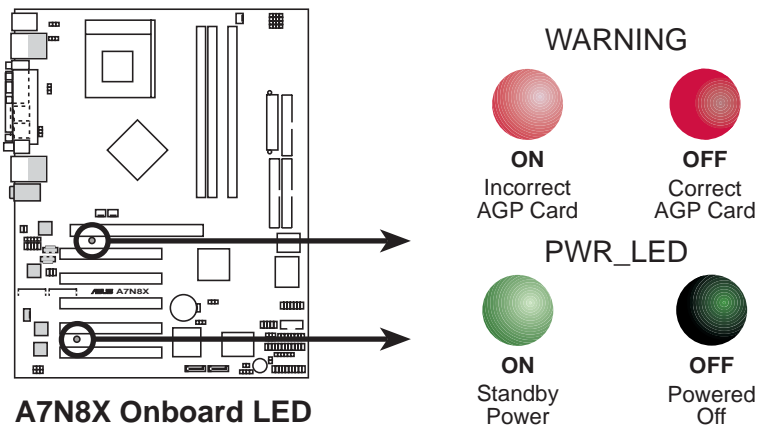

2.4 Central Processing Unit (CPU)

2.4.1 Overview

The motherboard provides a Socket A (462) for CPU installation. AMD processors offer gigahertz speeds to support all the latest computing platforms and applications. The A7N8X supports Athlon™ XP processors with “QuantiSpeed” data processing, large data caches, 3D enhancements and 333/266Mhz bus speeds.

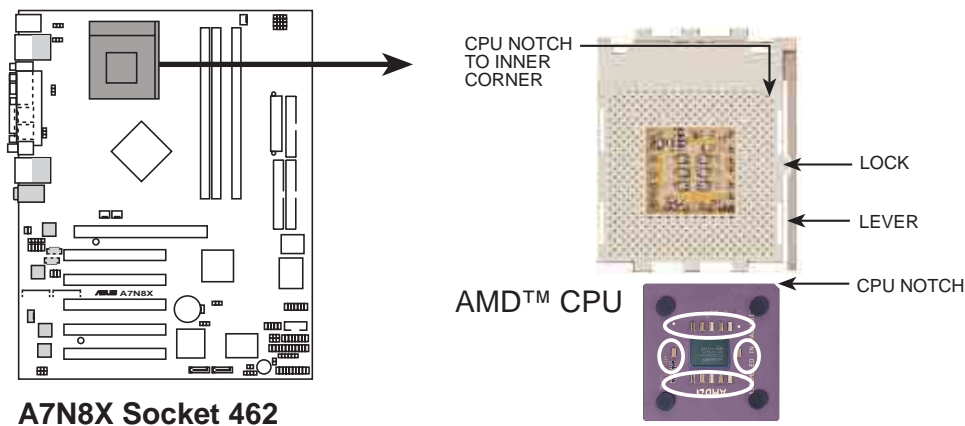

Each AMD CPU has a “marked” corner. This corner is usually indicated with a notch, and/or a golden square or triangle. Refer to this indicator while orienting the CPU. See the next page for installation details. *A fan and heatsink should be attached to the CPU to prevent overheating.*

2.4.2 Installing the CPU

Follow these steps to install a CPU:

1. Locate the Socket 462 and open it by pulling the lever gently sideways away from the socket. Then lift the lever upwards. The socket lever must be fully opened (90 to 100 degrees).
2. Insert the CPU with the correct orientation. The **notched or golden corner** of the CPU must be oriented toward the inner corner of the socket base nearest to the lever hinge.

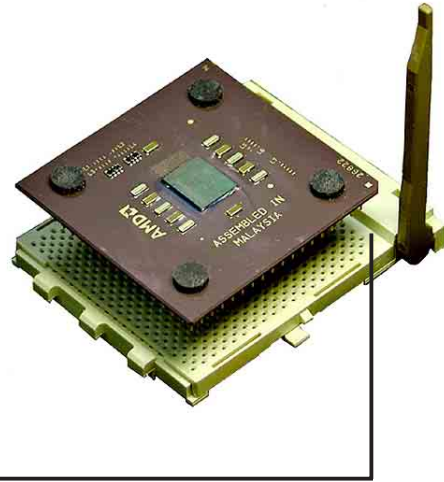

CAUTION! The CPU should drop easily into place. **Do not force the CPU** into the socket to avoid bending the pins. If the CPU does not fit, check its alignment and look for bent pins.

4. Once completely inserted, press the CPU firmly and close the socket lever until it snaps shut.
5. Place the CPU fan and heatsink on the CPU. The heatsink should entirely cover the CPU. Carefully attach the heatsink locking brace to the plastic clips on the socket base. With the added weight of the CPU fan and heatsink locking brace, no extra force is required to keep the CPU in place



CAUTION! Take care not to scrape the motherboard surface when mounting a clamp-style processor fan, or else damage may occur. When mounting a heatsink onto your CPU, make sure that exposed CPU capacitors do not touch the heatsink, or damage may occur!



NOTE! Do not neglect to set the correct Bus Frequency and leave the CPU Multiple setting at default to avoid start-up problems.

2.5 System memory

2.5.1 Overview

This motherboard uses *only* **Double Data Rate** (DDR) Synchronous Dynamic Random Access Memory (SDRAM) Dual Inline Memory Modules (DIMMs). These sockets support up to 1GB system memory using non-ECC PC400/333/266/200 DIMMs.

Each DIMM socket/module is two-sided: each side defines one “row” of memory. DIMMs come in combinations of single or double-sided types ranging through 64MB, 128MB, 256MB, 512MB to form a total memory size of *64MB to 1GB*.

~ Three (3) sockets are available for 400MHz-PC3200, 333MHz-PC2700, 266MHz-PC2100, or 200MHz-PC1600 DDR DIMMs to form a memory size of *64MB to 1GB*.

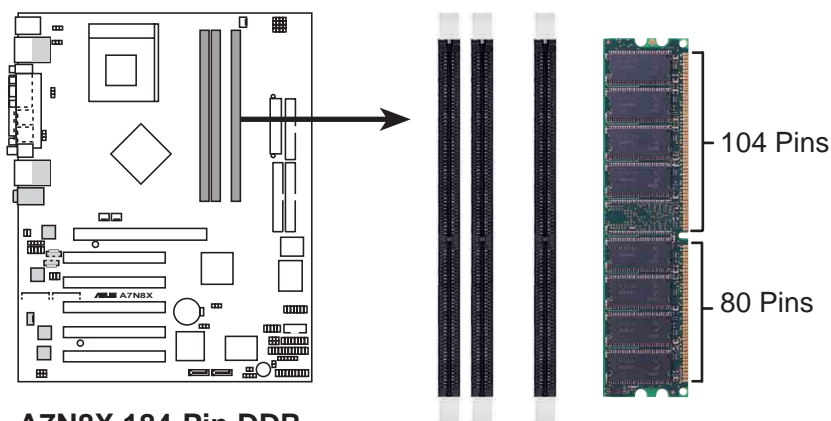

A7N8X 184-Pin DDR DIMM Sockets



CAUTION! DIMMs are keyed to fit into notches with only one direction. DO NOT force a DIMM into a socket to avoid damaging the DIMM.



- **DIMMs with more than 18 chips are not supported.**
 - ASUS motherboards support SPD (Serial Presence Detect) DIMMs. This is the memory of choice for best performance vs. stability
 - BIOS shows DDR SDRAM memory on bootup screen.
-

2.5.2 Memory configurations

Install DIMMs in any of the following combinations.

DIMM Location	184-pin DIMM (DDR)	Total Memory
Socket 1 (Rows 0&1)	64MB, 128MB, 256MB, 512MB, 1G	x1
Socket 2 (Rows 2&3)	64MB, 128MB, 256MB, 512MB, 1G	x1
Socket 2 (Rows 4&5)	64MB, 128MB, 256MB, 512MB, 1G	x1
Total system memory (Max. 3GB)		=



NOTE: To enhance system performance, utilize dual-channel feature when installing additional DIMMs. You may install the DIMMs in the following sequence: Sockets 1 and 3 or Sockets 2 and 3 or Sockets 1, 2 and 3.

2.5.3 Installing a DIMM



CAUTION! Make sure to unplug the power supply before adding or removing DIMMs or other system components. Failure to do so may cause severe damage to both the motherboard and the components.

Installing a DIMM:

1. Unlock a DIMM socket by pressing the retaining clips outward.
2. Align a DIMM on the socket such that the notches on the DIMM exactly match the notches in the socket.
3. Firmly insert the DIMM into the socket until the retaining clips snap back in place.

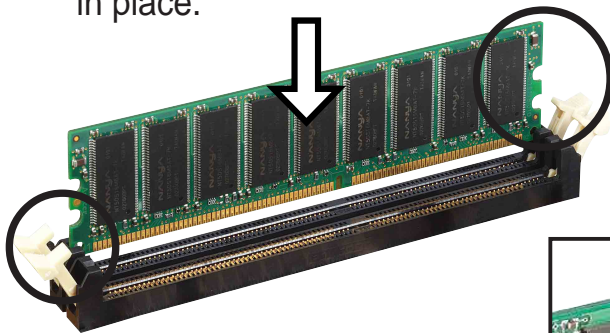

NOTE: Visit the ASUS website at www.asus.com for the latest DIMM Qualified Vendors List. Make sure to use only tested and qualified DDR400 DIMMs.

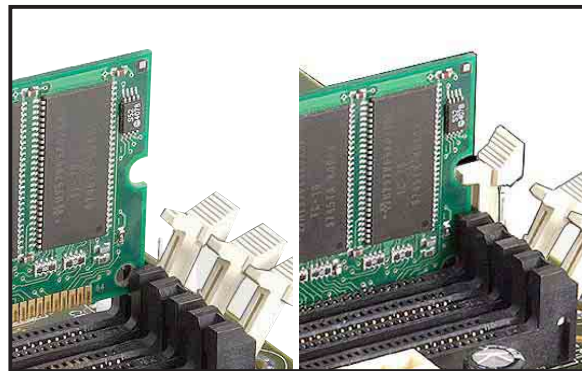

Unlocked Retaining Clip

Locked Retaining Clip

2.6 Expansion slots

The motherboard has three PCI slots and one Accelerated Graphics Port (AGP) slot.. The following sub-sections describe the slots and the expansion cards that they support.



WARNING! Unplug your power supply when adding or removing expansion cards or other system components. Failure to do so may cause you physical injury and damage motherboard components.

2.6.1 Installing an expansion card

Follow these steps to install an expansion card.

1. Before installing the expansion card, read the documentation that came with it and make the necessary hardware settings.
2. Remove the system unit cover (if your motherboard is already installed in a chassis).
3. Remove the bracket opposite the PCI slot. Keep the screw for later use.
4. Align the card connector with the slot and press firmly until the card is completely seated on the slot.
5. Secure the card to the chassis with the screw you removed earlier.
6. Replace the system cover.
7. Set up the BIOS if necessary.
8. Install the necessary software drivers for your expansion card.

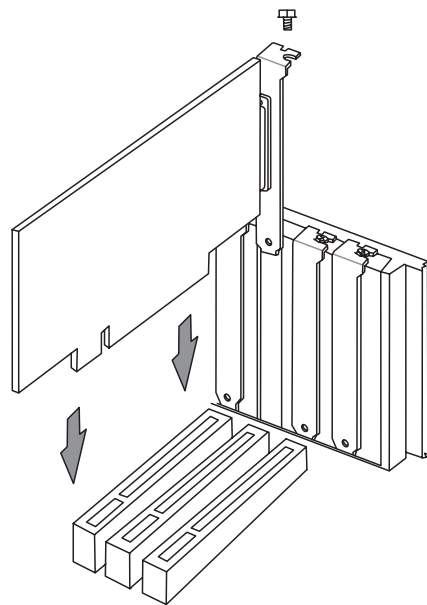

2.6.2 Configuring an expansion card

Some expansion cards need an IRQ to operate. Generally, an IRQ must be exclusively assigned to one function at a time. In a standard design configuration, 16 IRQs are available but most are already in use. Normally, 6 IRQs are free for expansion cards. If the motherboard has **PCI** audio onboard, an additional IRQ will be used. If your motherboard also has **MIDI** enabled, another IRQ will be used, leaving 4 IRQs free. Sometimes IRQs are “shared” by more than one function; in this case, IRQ assignments are swapped automatically or adjusted through the BIOS firmware.



IMPORTANT! When using PCI cards on shared slots, ensure that the drivers support “Share IRQ” or that the cards do not need IRQ assignments. Otherwise, conflicts will arise between the three PCI groups, making the system unstable and the card inoperative.

Standard Interrupt Assignments

IRQ	Priority	Standard Function
0	1	System Timer
1	2	Keyboard Controller
2	N/A	Programmable Interrupt
3*	11	Communications Port (COM2)
4*	12	Communications Port (COM1)
5*	13	Sound Card (sometimes LPT2)
6	14	Floppy Disk Controller
7*	15	Printer Port (LPT1)
8	3	System CMOS/Real Time Clock
9*	4	ACPI Mode when used
10*	5	IRQ Holder for PCI Steering
11*	6	IRQ Holder for PCI Steering
12*	7	PS/2 Compatible Mouse Port
13	8	Numeric Data Processor
14*	9	Primary IDE Channel
15*	10	Secondary IDE Channel

*These IRQs are usually available for ISA or PCI devices.

Interrupt Request Table for this Motherboard

	INT-A	INT-B	INT-C	INT-D
PCI slot 1	shared	—	—	—
PCI slot 2	—	—	—	used
PCI slot 3	—		shared	—
PCI slot 4	—	used	—	—
PCI slot 5	shared		—	—
Serial ATA	—	—	shared	—

2.6.3 PCI slots

Three 32-bit PCI slots are available on this motherboard. The slots support PCI cards such as a LAN card, SCSI card, USB card, and other cards that comply with PCI specifications.

This figure shows a typical PCI card installed into a slot:



2.6.4 AGP slot

This motherboard provides an Accelerated Graphics Port (AGP 8X) slot to support AGP graphics cards. Take note of the notches on the card golden fingers to ensure that they fit the AGP slot on your motherboard. Below is an example of a +1.5V AGP card.

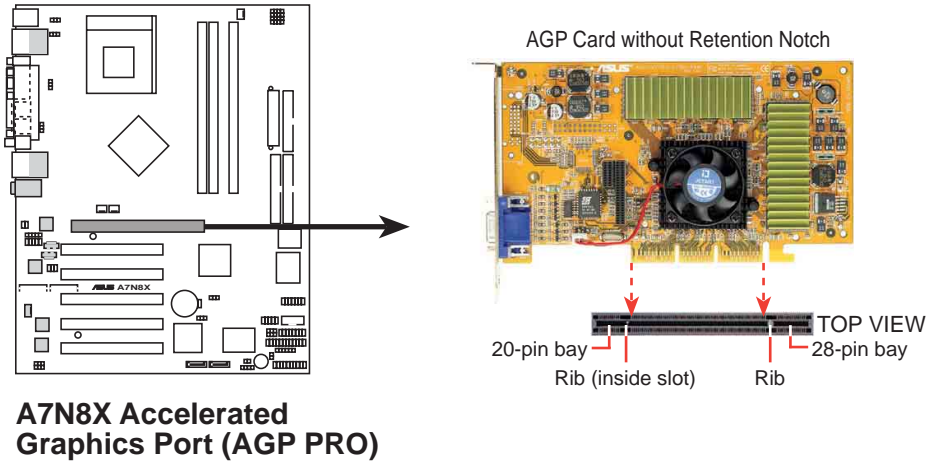

CAUTION! To avoid damaging your AGP graphics card, your computer's power supply should be unplugged before inserting your graphics card into the slot.

2.7 Jumpers

The jumpers on the motherboard allow you to change some feature settings to suit your customized system configuration.

1) Serial ATA Setting (3 pin SATA_EN1)

This jumper permits selection of the serial ATA headers for connection of serial ATA hard disk drives and other serial IDE devices. The default setting [1-2] enables the serial headers. Disable the serial headers by changing the jumpers to [2-3].

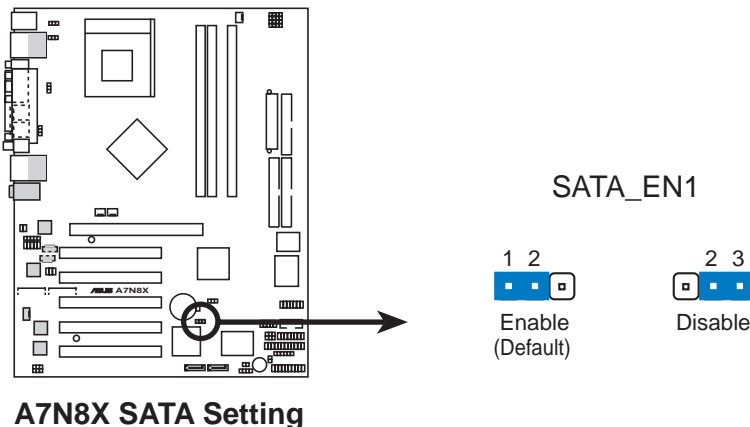

2) Keyboard Wake Up (3 pin KBPWR1)

This allows you to disable or enable the keyboard power up function. Retain the default setting of [1-2] to disable computer keyboard-wake-up function. If you set to [2-3] you may use your keyboard by pressing <Spacebar> to wake up your computer. This feature requires an ATX power supply that can supply at least 1A on the +5VSB lead.

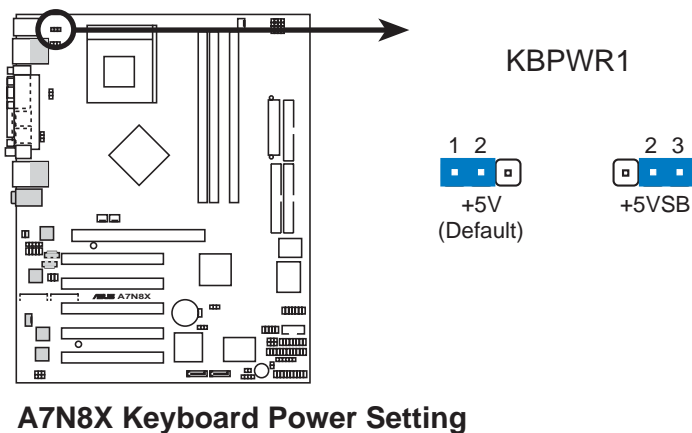

3) USB Device Wake-up (2x3 pin USBPWR12, 34, 56)

Set these jumpers to +5V to allow wake up from the S1 sleep state (CPU stopped; RAM refreshed; system running in low power mode) using the connected USB devices. Set to +5VSB to allow wake up from S3 sleep state (no power to CPU; RAM in slow refresh; power supply in reduced power mode). The default setting for the three jumpers is 1-2 to select +5V (because not all computers have the appropriate power supply).

The USBPWR01 jumper activates the rear panel USB ports. The USBPWR23 jumper activates the internal header, USB23

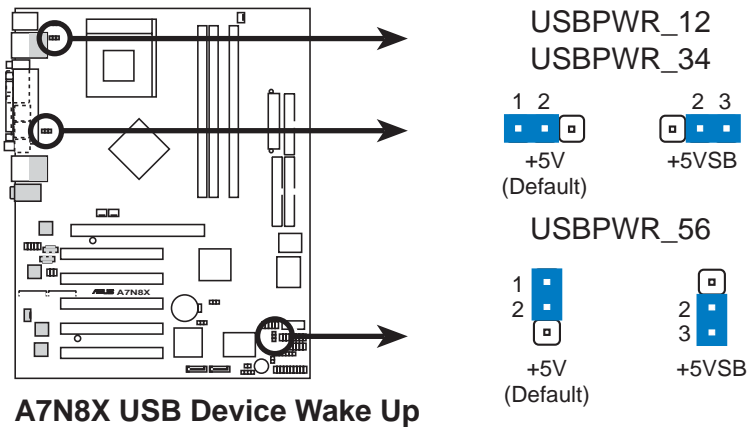

NOTE! This feature requires an ATX power supply that can supply at least 2A on the +5VSB lead when these jumpers are set to +5VSB. Otherwise, the system does not power up. The total current consumed must NOT exceed the power supply capability (+5VSB) whether under normal working conditions or in sleep mode.

4) Clear RTC RAM/CMOS (CLRRTC1)

This jumper clears the Real Time Clock (RTC) RAM of date, time, and system setup parameters in CMOS. The RAM data in CMOS is powered by the onboard button cell battery.

To erase the RTC RAM:

1. Turn OFF the computer and unplug the power cord.
2. Remove the battery.
3. Move the jumper caps from [1-2] to [2-3] momentarily. Replace the jumper cap to the original position, [1-2].
4. Re-install the battery.
5. Plug the power cord and turn ON the computer.
6. Hold down the key during the boot process and enter BIOS setup to re-enter data.

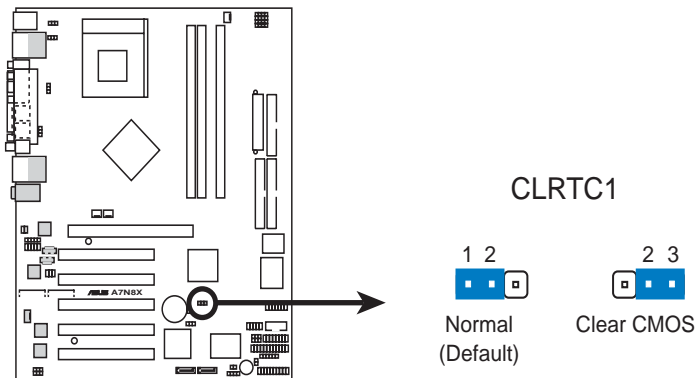

A7N8X Clear RTC RAM

5) Central Processing Unit FSB (CPU_FSB)

This jumper when set to 1-2 pins (default), enable support for Front Side Bus 333/266. When set to pins 2-3, it sets support for FSB 200 only.

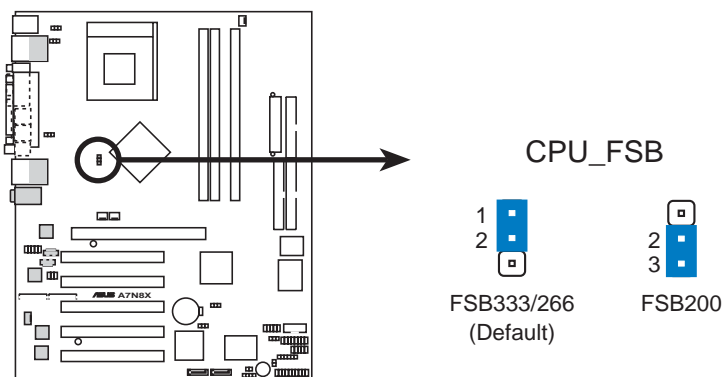

A7N8X CPU FSB Jumper Setting

2.8 Connectors

This section describes and illustrates the internal connectors on the motherboard.



WARNING! Some pins are used for connectors or power sources. These are clearly distinguished from jumpers in the Motherboard Layout. Placing jumper caps over these connector pins will cause damage to your motherboard.



IMPORTANT! Ribbon cables should always be connected with the red stripe to Pin 1 in the connector socket.

1) PS/2 Mouse Port (Green 6-pin PS2KBMS)

The system automatically directs IRQ12 to the PS/2 mouse if one is detected. If no mouse is detected, IRQ12 become available to expansion cards.

PS/2 Mouse (6-pin Female)

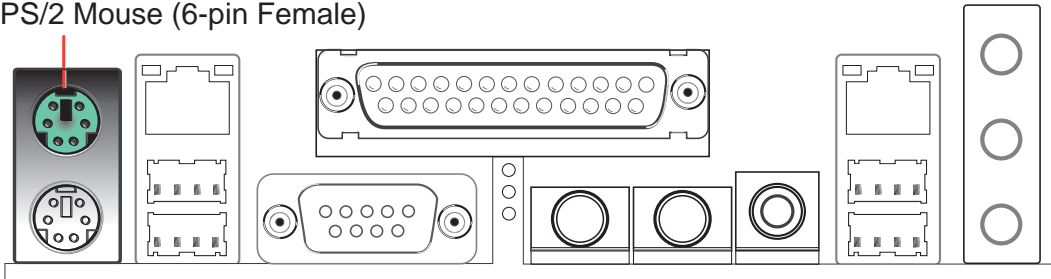

2) PS/2 Keyboard Port (Purple 6-pin PS2KBMS)

This connection is for a standard keyboard using an PS/2 plug (mini DIN). This connector does not allow standard AT size (large DIN) keyboard plugs. You may use a DIN to mini DIN adapter on standard AT keyboards.

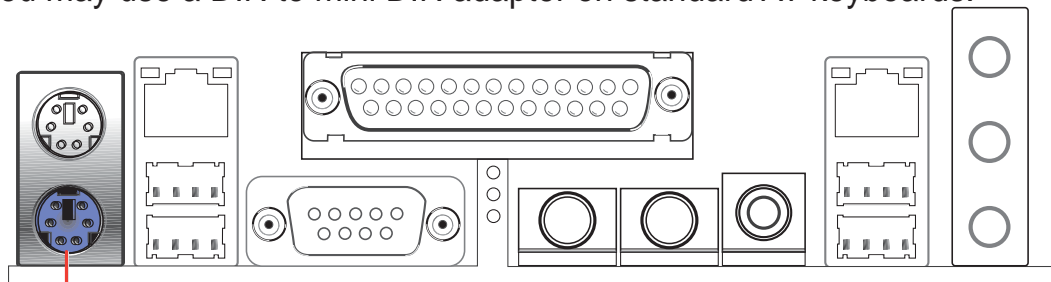

PS/2 Keyboard (6-pin Female)

3) Universal Serial Bus Ports 0 and 1 (Black four x 4-pin USB)

Four USB ports are available for connecting USB devices.

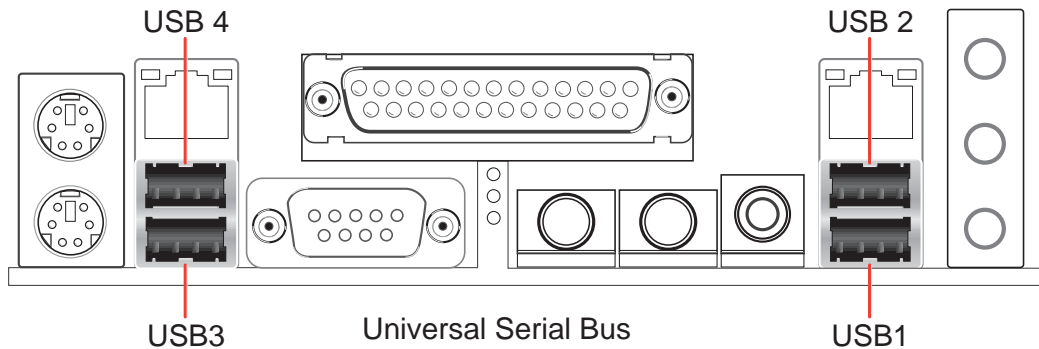

4) Serial Port and Header (Teal/Turquoise, One 9-pin COM1, One 10-1 pin COM2)

One serial port can be used for pointing devices or other serial devices. The other is available as an onboard header. To enable these ports, see **Onboard Serial Port 1 / Onboard Serial Port 2** in **4.4.3 Integrated Peripherals** for the settings.

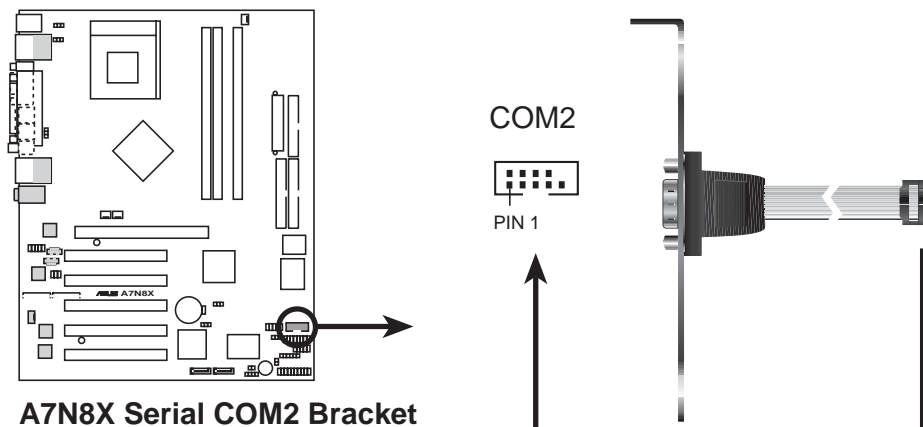
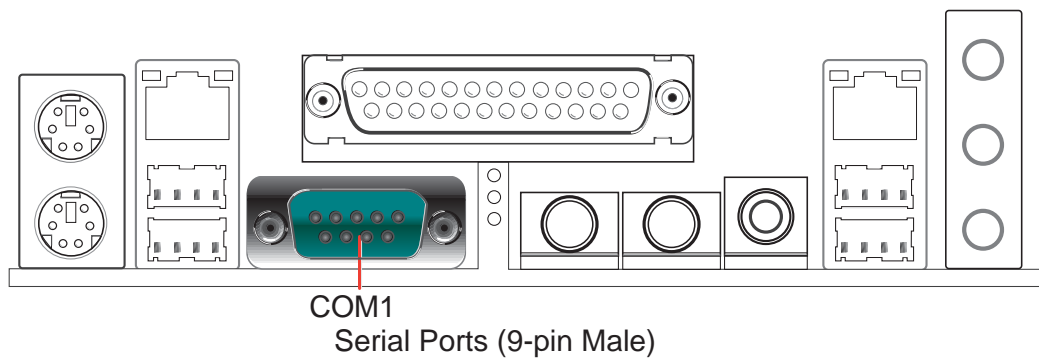

5) Fast-Ethernet Port Connector (Two x RJ45) (Optional)

These RJ45 connectors are located on top of the USB Ports 1/2 and 3/4. The RJ45 supports connectivity for local area networks.

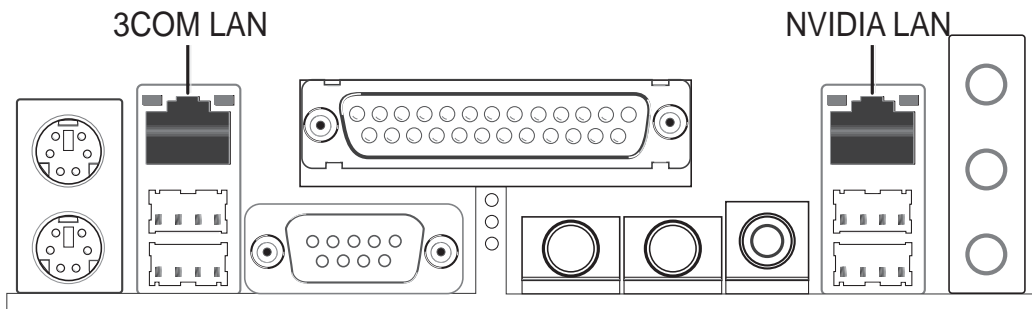

6) Parallel Port (Burgundy 25-pin PRINTER)

You can enable the parallel port and choose the IRQ through **Onboard Parallel Port** (see 4.4.3 Integrated Peripherals).



NOTE! Serial printers must be connected to the serial port.

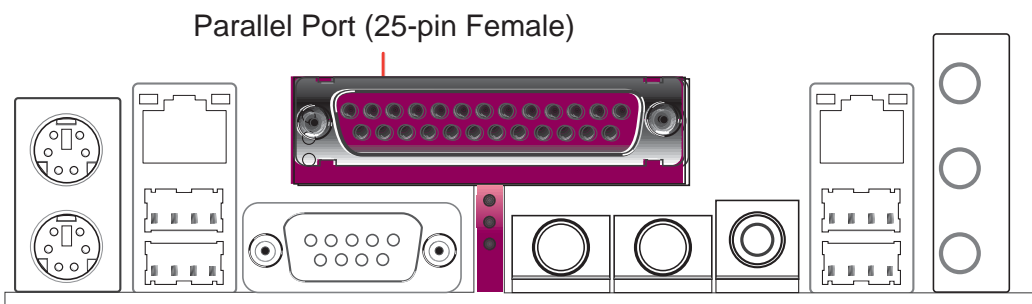

7) Audio Connectors (Three 1/8" AUDIO) (Optional)

For a 2-speaker audio output, the **Line Out** (lime) connects a headphone or speakers. The **Line In** (light blue) connects a tape players or other audio sources. The **Mic** (pink) connects a microphone.

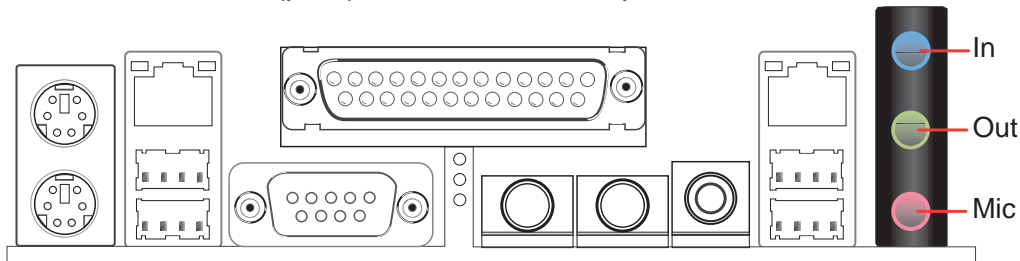

For a 4 or 6 speaker audio output, the Line In (light blue) connects to other audio sources. The Line Out (lime) connects to the Left/Right Front Speakers. The Mic (pink) connects to a microphone. The Surround L/R audio connector connects to the Left/Right Surround speakers. The Center/LFE connector connects to the Center speakers or Bass speakers.

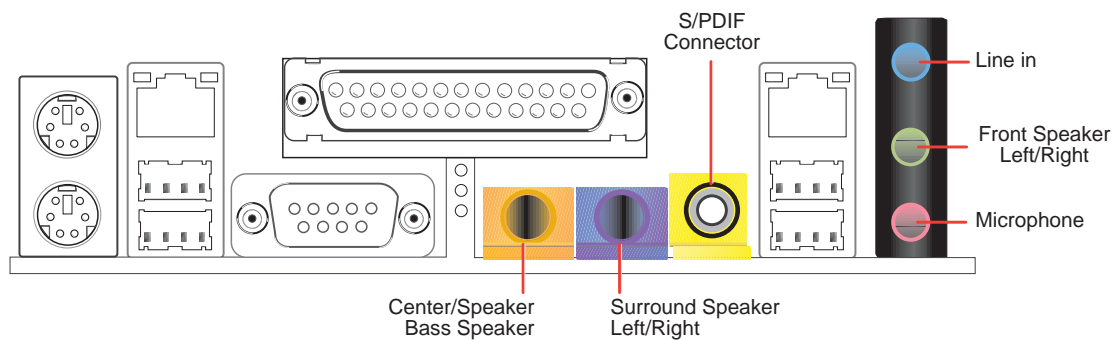

NOTE! If you want to use 4/6 speaker output but only has 3 audio jacks available on your back panel I/O, refer to Chapter 5.7.2.

8) IDE Activity LED (2-pin IDELED)

This connector supplies power to the cabinet's IDE activity LED. Read and write activity by devices connected to the Primary or Secondary IDE connectors cause the IDE LED to light up.

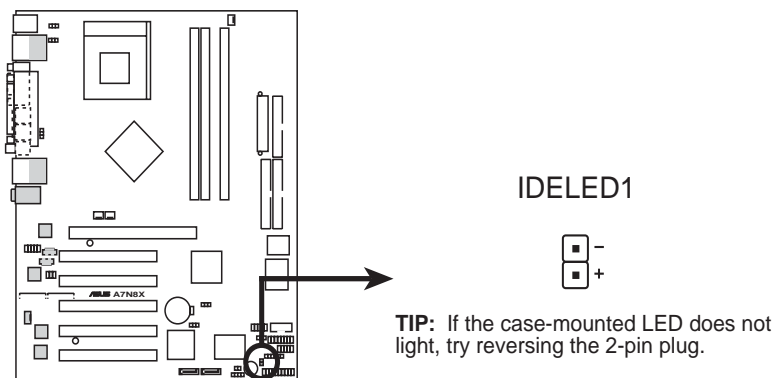

A7N8X IDE Activity LED

9) Floppy Disk Drive Connector (34-1 pin FLOPPY)

This connector supports the provided floppy drive ribbon cable. After connecting the single end to the board, connect the two plugs on the other end to the floppy drives. **(Pin 5 is removed to prevent inserting in the wrong orientation when using ribbon cables with pin 5 plugged).**

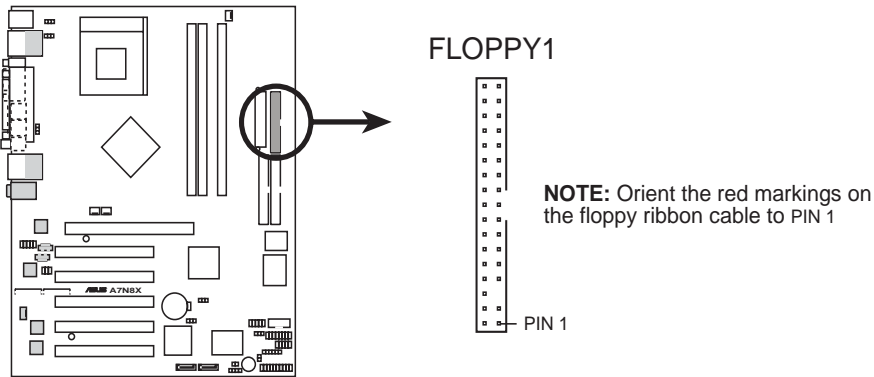

A7N8X Floppy Disk Drive Connector

10) Primary (Blue) / Secondary (Black) IDE Connectors (40-1 pin PRI_IDE1 and SEC_IDE1)

The Primary and Secondary IDE connectors support the IDE hard disk ribbon cables supplied with the motherboard. Connect the cable's blue connector to the motherboard's primary IDE connector (recommended) or the secondary IDE connector. Connect the opposite end of the cable to your UltraDMA133/100/66 device (hard disk drive). If a second hard disk drive is connected, you may reset its jumper to Slave or Master/Slave mode. Non-UltraDMA133/100/66 devices should be connected to the secondary IDE connector. BIOS supports specific device bootup (**see 4.4.1 Advanced BIOS Features**).



IMPORTANT! UltraDMA133 IDE devices require a 40-pin 80-conductor cable and RAID arrays *only operate* with such cables.

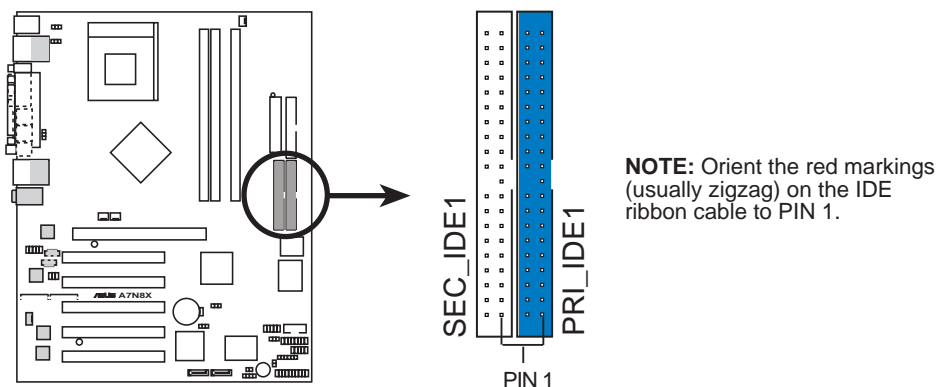

A7N8X IDE Connectors

11) SATA Serial ATA Connectors (2 x 7-pin PRI_SATA1, SEC_SATA1) (Optional)

Two headers support serial ATA133 devices including hard-drives and cd-roms.

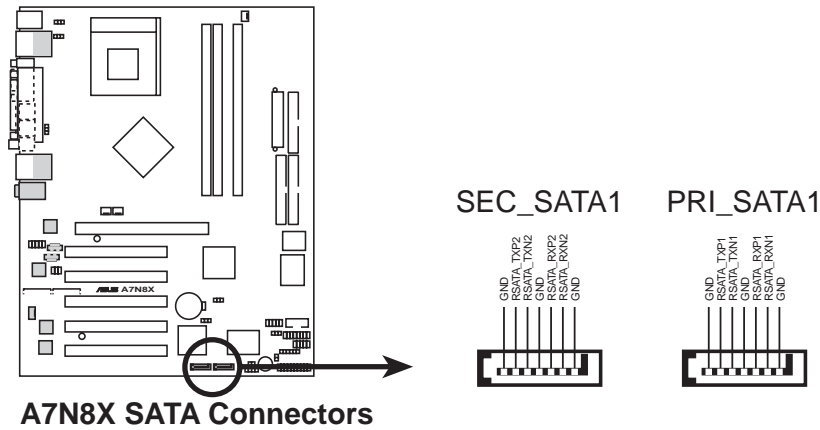

12) Infrared Module connector (10-1 or 10-2 pin IR_CON1)

These connectors support an optional wireless transmitting and receiving infrared module. The module mounts to a small opening on the system chassis that support this feature. You must also configure the UART2 Use As parameter in BIOS to set UART2 for use with IR.

Use the ten pins as shown in Back View and connect a ribbon cable from the module to the motherboard SIR connector according to the pin definitions.

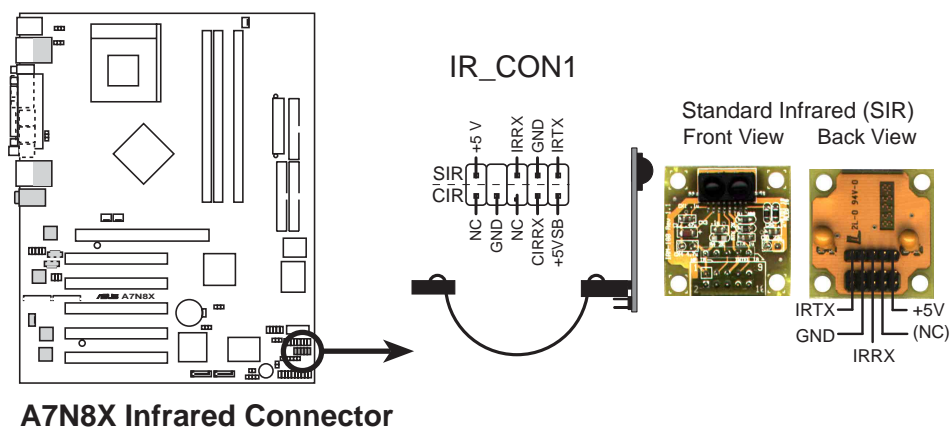

13) CPU/Power/Chassis Fan Connectors (3-pin CPU_FAN1, PWR_FAN1, CHA_FAN1)

Three fan connectors support cooling fans of 350mA (4.2 Watts) or less. Orient the fans so that airflow flows across the onboard heat sinks instead of expansion slots. The fan wiring and plug vary depending on the type employed. Connect the fan cable to the connector, ensuring that the black wire matches the ground pin. (Use the "Rotation" signal only with a specially designed fan with a rotation signal. You can monitor the Rotations Per Minute (RPM) using ASUS PC Probe (see **5. SOFTWARE SUPPORT**).



WARNING! Make sure to connect the fan cables to the fan connectors. Lack of sufficient airflow within the system could cause damage to the motherboard. **These are not jumpers, do not place jumper caps over these connectors!**

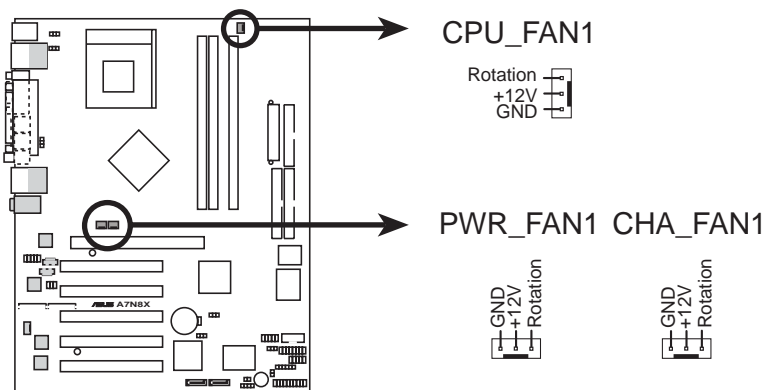

A7N8X 12-Volt Cooling Fan Power

14) IEEE-1394 Header (8-pin 1394HEAD) (*Optional*)

This header supports an IEEE-1394 serial connector cable set that mounts to a standard expansion slot in the computer case. 1394-compliant internal fixed disk drives may also be connected to these headers.

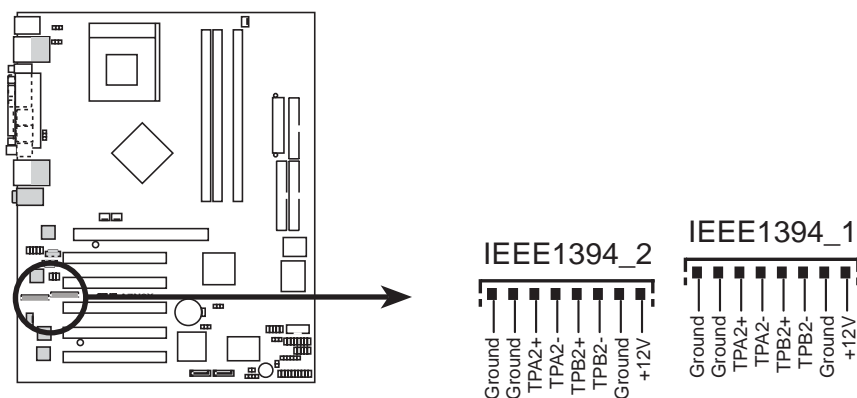

A7N8X 1394 Headers

15) Power Supply Connectors (20 pin block ATXPWR1)

This connector supports an ATX 12V power supply. The plug from the power supply fits in only one orientation. Push down firmly ensuring that the pins are aligned.



IMPORTANT! Make sure that the ATX 12V power supply offers at least 1A on the +5-volt standby lead (+5VSB). The minimum recommended wattage is 230W or 300W for a fully configured system. The system may become unstable and may experience difficulty powering up if the power supply is inadequate.

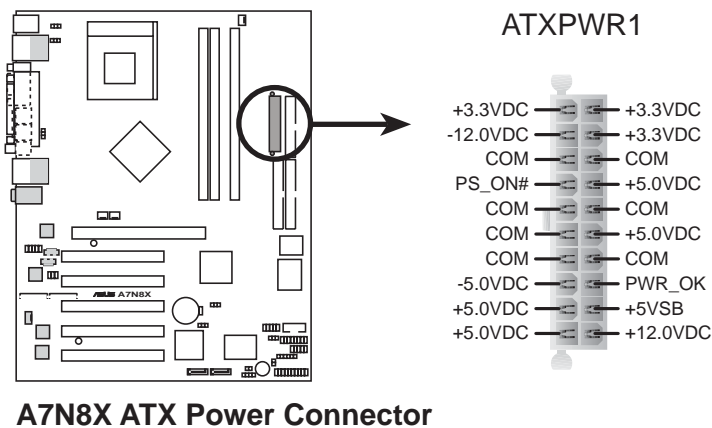

A7N8X ATX Power Connector

16) SMBus Connector (6-1 pin SMB)

This connector supports SMBus (System Management Bus) devices. SMBus devices communicate by means of the SMBus with an SMBus host and/or other SMBus devices. SMBus is a multi-device bus that permits multiple chips to connect to the same bus and enable each one to act as a master by initiating data transfer.

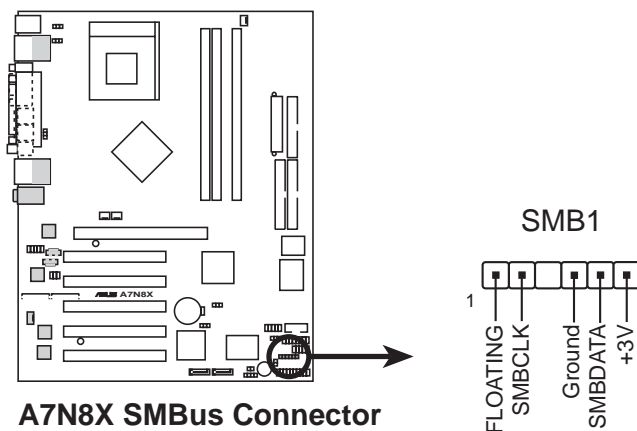

A7N8X SMBus Connector

17) Internal Audio Connectors (Two x 4 pin CD1, AUX1, MODEM1)

These connectors allow you to receive stereo audio input from sound sources as a CD-ROM, TV tuner, Modems, or MPEG card.

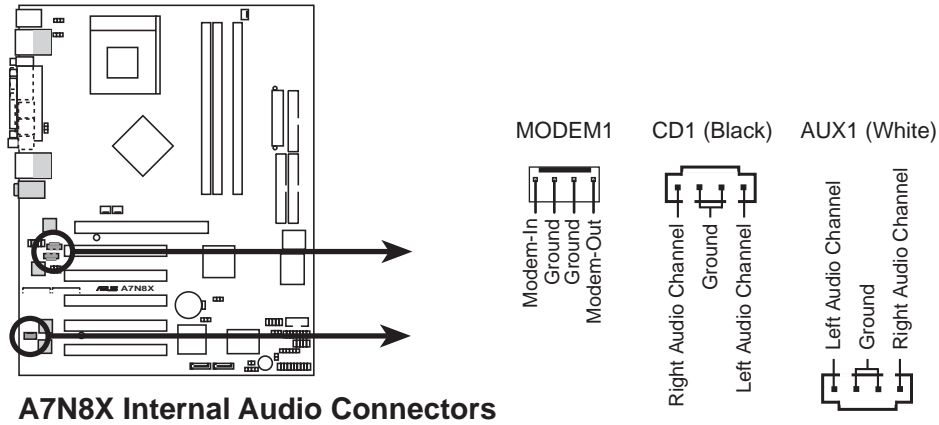

18) Digital Audio Interfaces (6 pin SPDIF1) (*Optional*)

This connector is for optional S/PDIF audio module that allows digital instead of analog sound input and output.

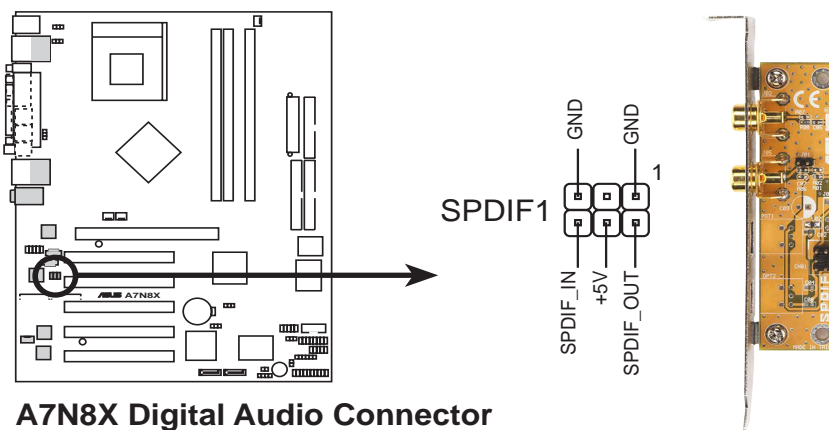

IMPORTANT! For S/PDIF out function, you may use either the module or the S/PDIF connector at the back panel, but not both.

19) USB Headers (10-1 pin USB_56) (Optional)

If the USB 2.0 port connectors on the back panel are inadequate, one USB header is available for four additional USB port connectors. Connect a 2-port USB connector set to a USB header and mount the USB bracket to an open slot in the chassis. (The USB connector set is optional and does not come with the motherboard package.)

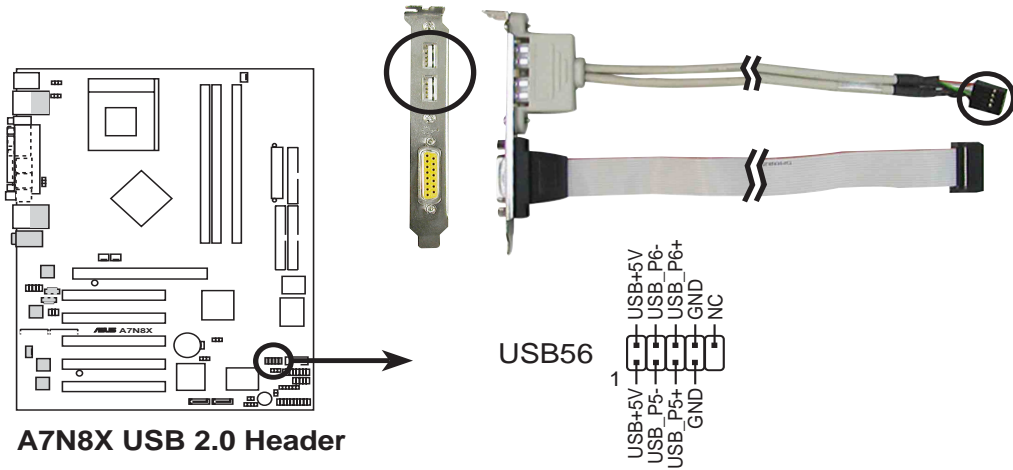

20) Power Supply Thermal Sensor (2-pin PWRTEMP1) (Optional)

This header supports a thermal sensor for the power supply.

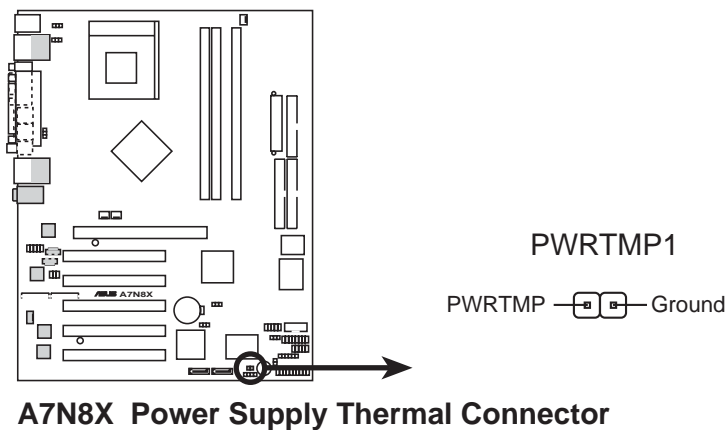

21) Game Connector (16-1 pin GAME)

This connector supports an external game port. An example of a PCI game port is illustrated.

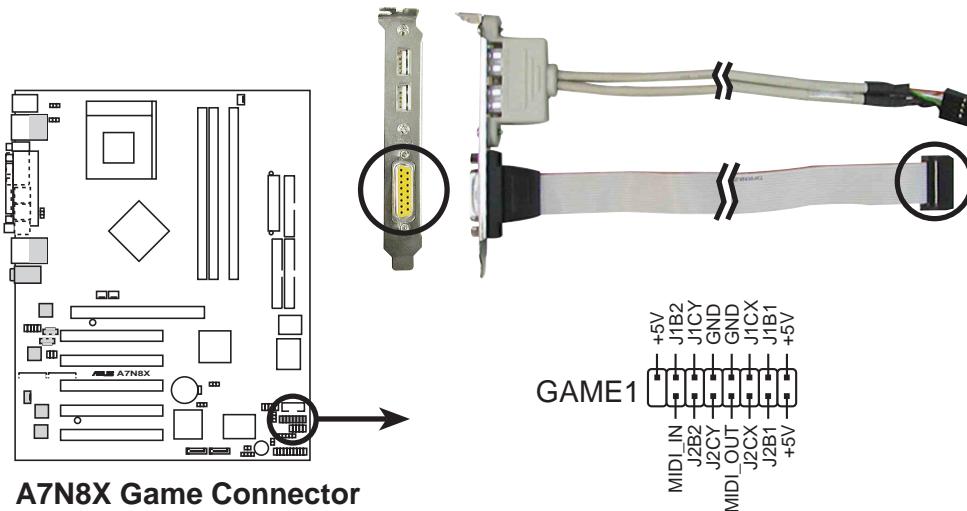

A7N8X Game Connector

22) Chassis Open Alarm Lead (4-1 pin CHASSIS1)

This lead is intended for a chassis designed to support intrusion detection. The lead requires an external detection mechanism such as a chassis intrusion monitor/sensor or microswitch. When any chassis component is removed, the sensor is triggered and a high-level signal is sent to this lead to record a chassis intrusion event. The event is then be processed by software such as LDCM. When not using the chassis intrusion lead, place a jumper cap over the pins (PINS 3-4) to close the circuit. Removing the jumper cap will prevent the system from booting up.

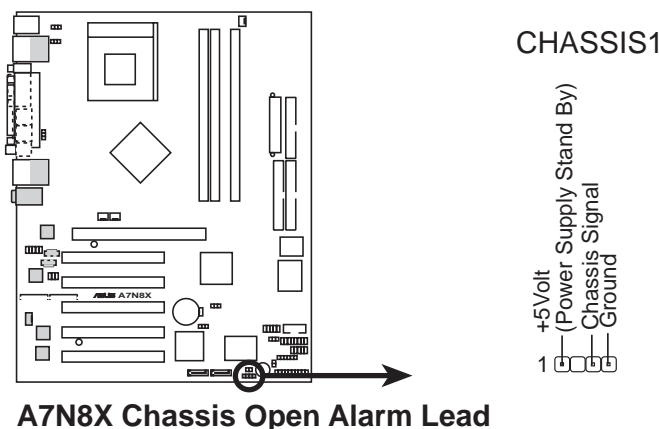

A7N8X Chassis Open Alarm Lead

23) Front Panel Audio connector (10-1 pin FPAUDIO1)

This is an interface for the Intel front panel audio cable that allow convenient connection and control of audio devices.

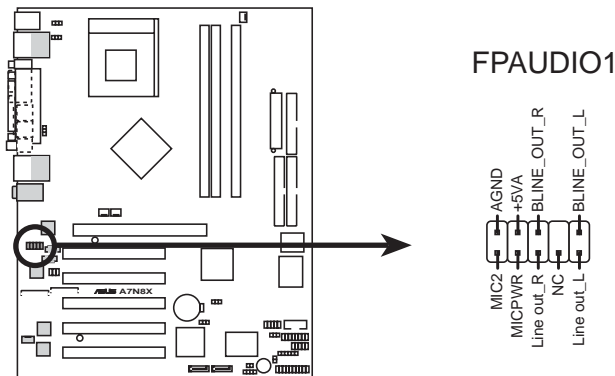

A7N8X Front Panel Audio Connector

The following 20-pin PANEL illustration is for items 24-29.

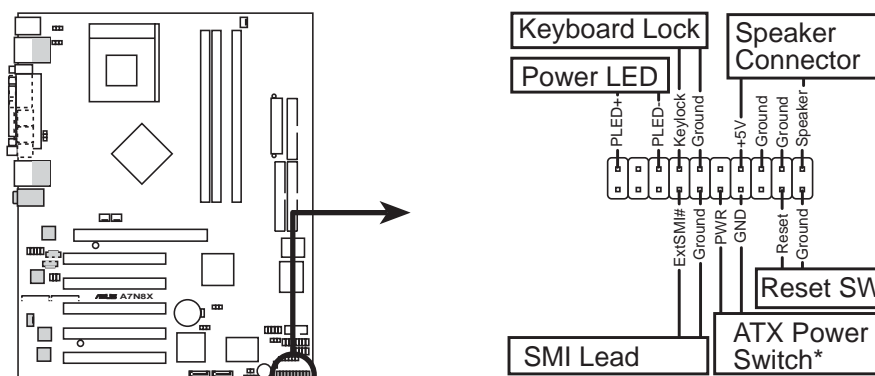

A7N8X System Panel Connectors

* Requires an ATX power supply.

24) System Power LED Lead (3-1 pin PWR_LED)

This 3-1 pin connector supplies the system power LED. The LED lights up when the system power is on, and the LED blinks when the system is in sleep or soft-off mode.

25) Keyboard Lock Switch Lead (2 pin KEYLOCK)

This 2-pin connector supplies the case-mounted key switch for keyboard locking.

26) System Warning Speaker Lead (4 pin SPEAKER)

This 4-pin connector supplies the case-mounted speaker to sound system beeps and warnings.

27) System Management Interrupt Lead (2 pin SMI)

This 2-pin connector permits switching to suspend mode, or “Green” mode, in which system activity is instantly decreased to save power and to expand the life of certain system components. Attach the case-mounted suspend switch this 2-pin connector.

28) ATX Power Switch / Soft-Off Switch Lead (2 pin PWR)

The system power is controlled by a momentary switch attached to this connector. Pressing the button switches the system between ON and SLEEP, or ON and SOFT OFF, depending on the BIOS or OS settings. Pressing the button while in the ON mode for more than 4 seconds turns the system off.

29) Reset Switch Lead (2 pin RESET)

This 2-pin connector supports the case-mounted reset switch for rebooting the system without turning off the power switch.

Chapter 3

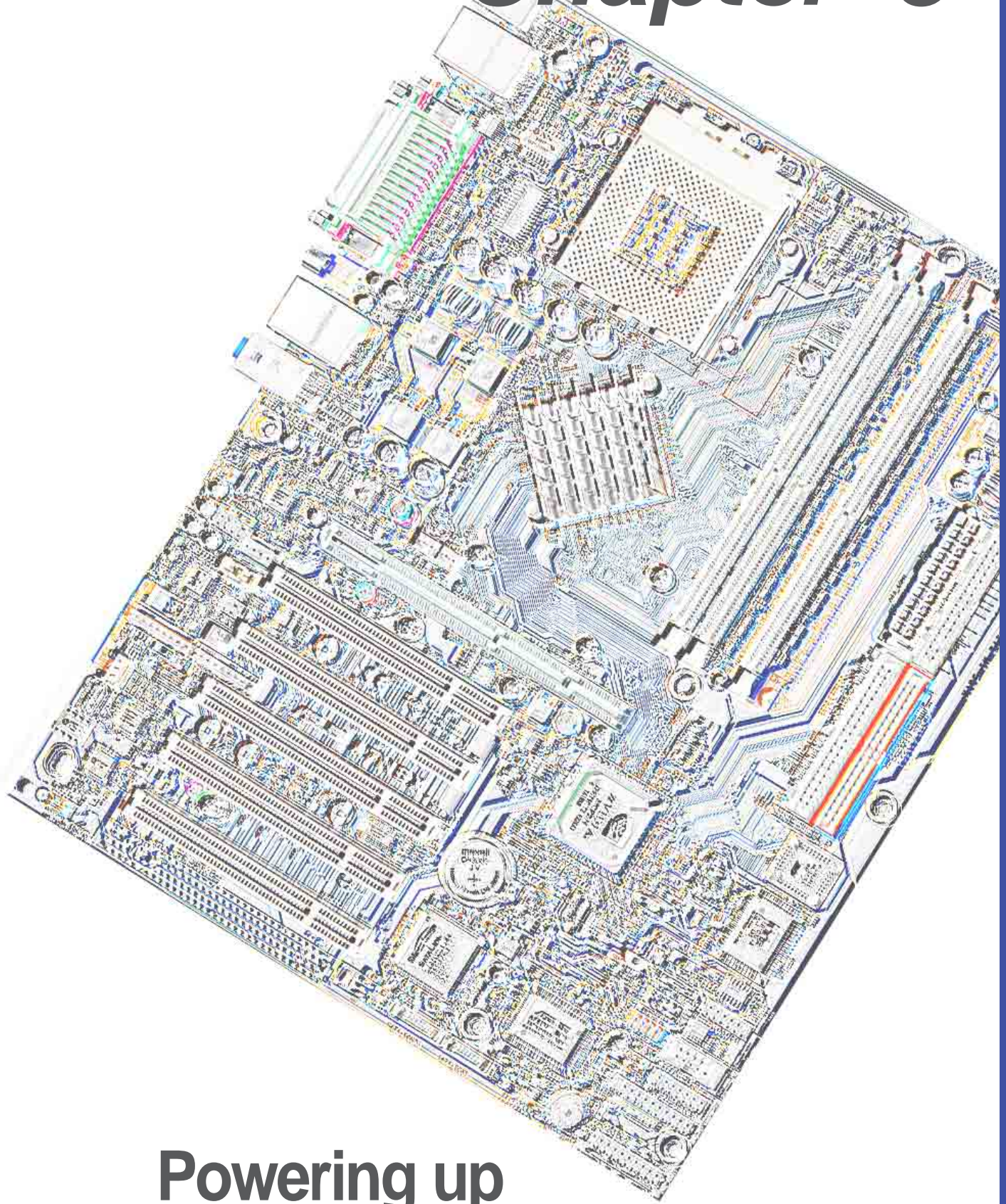

Powering up

3.1 Starting up for the first time

1. After making all the connections, replace the system case cover.
2. Be sure that all switches are off.
3. Connect the power cord to the power connector at the back of the system chassis.
4. Connect the power cord to a power outlet that is equipped with a surge protector.
5. Turn on the devices in the following order:
 - a. Monitor
 - b. External SCSI devices (starting with the last device on the chain)
 - c. System power (if you are using an ATX power supply, you need to switch on the power supply as well as press the ATX power switch on the front of the chassis).
6. After applying power, the power LED on the system front panel case lights up. For ATX power supplies, the system LED lights up when you press the ATX power switch. If your monitor complies with “green” standards or if it has a “power standby” feature, the monitor LED may light up or switch between orange and green after the system LED turns on. The system then runs the power-on tests. While the tests are running, the BIOS beeps or additional messages appear on the screen. If you do not see anything within 30 seconds from the time you turned on the power, the system may have failed a power-on test. Check the jumper settings and connections or call your retailer for assistance.

Award BIOS Beep Codes

Beep	Meaning
One short beep when displaying logo	No error during POST
Long beeps in an endless loop	No DRAM installed or detected
One long beep followed by three short beeps	Video card not found or video card memory bad
High frequency beeps when system is working	CPU overheated; System running at a lower frequency

7. At power on, hold down <Delete> to enter BIOS Setup. Follow the instructions in Chapter 4.

3.2 Vocal POST Messages

This motherboard includes the Winbond speech controller to support a special feature called the ASUS POST Reporter™. This feature gives you vocal POST messages and alerts to inform you of system events and boot status. In case of a boot failure, you will hear the specific cause of the problem.

These POST messages are customizable using the Winbond Voice Editor software that came with your package. You can record your own messages to replace the default messages.

Following is a list of the default POST messages and their corresponding actions, if any.

POST Message	Action
No CPU installed	<ul style="list-style-type: none">• Install an AMD Thoroughbred/Athlon XP/Athlon/ Duron Processor into the CPU socket.
System failed CPU test	<ul style="list-style-type: none">• Check the CPU if properly installed.• Call ASUS technical support for assistance. See the “ASUS contact information” on page x.
System failed memory test	<ul style="list-style-type: none">• Install 184-pin unbuffered PC3200/2700/2100/1600 DIMMs into the DIMM sockets.• Check if the DIMMs on the DIMM sockets are properly installed.• Make sure that your DIMMs are not defective.• Refer to section “2.5 System memory” for instruction on installing a DIMM.
System failed VGA test	<ul style="list-style-type: none">• Install a PCI VGA card into one of the PCI slots, or an AGP card into the AGP slot.• Make sure that your VGA/AGP card is not defective.
System failed due to CPU over-clocking	<ul style="list-style-type: none">• Check your CPU settings in BIOS and make sure you only set to the recommended settings. See section “4.4.2 Advanced Chipset features.”

POST Message	Action
No keyboard detected	<ul style="list-style-type: none"> • Check your keyboard if properly connected to the purple PS/2 connector on the rear panel. • See section “1.4.1 Major components” for the location of the connector.
No floppy disk detected	<ul style="list-style-type: none"> • Make sure you have connected a floppy disk to the floppy disk connector on the motherboard. • See section “2.8 Connectors.”
No IDE hard disk detected	<ul style="list-style-type: none"> • Make sure you have connected an IDE hard disk drive to the one of the IDE connectors on the motherboard. • See section “2.8 Connectors.”
CPU temperature too high	<ul style="list-style-type: none"> • Check CPU fan if working properly.
CPU fan failed	<ul style="list-style-type: none"> • Check the CPU fan and make sure it turns on after you applied power to the system.
CPU voltage out of range	<ul style="list-style-type: none"> • Check your power supply and make sure it is not defective. • Call ASUS technical support for assistance. See the “ASUS contact information” on page x.
System completed Power-On Self Test	<ul style="list-style-type: none"> • No action required
Computer now booting from operating system	<ul style="list-style-type: none"> • No action required



You may disable the ASUS Speech POST Reporter™ in the BIOS setup. See section “4.4.1 Advanced BIOS Features”.

3.3 Powering off the computer

You must first exit the operating system and shut down the system before switching off the power. For ATX power supplies, you can press the ATX power switch after exiting or shutting down the operating system. If you use Windows 95/98/2000/XP, click the Start button, click Shut Down, then click the OK button to shut down the computer. The power supply should turn off after Windows shuts down.



The message “You can now safely turn off your computer” does not appear when shutting down with ATX power supplies.

Chapter 4

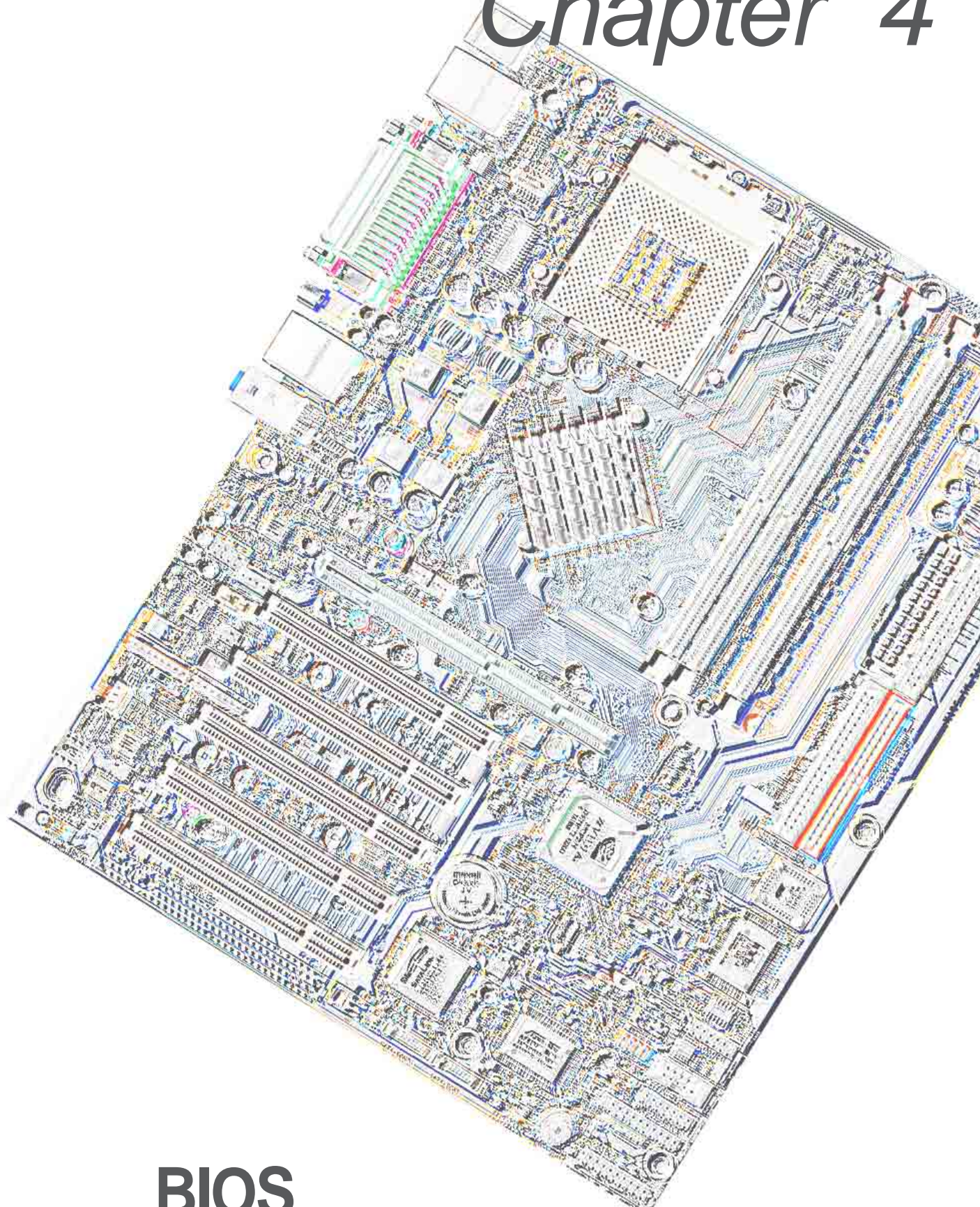

BIOS

4.1 Managing and updating your BIOS

4.1.1 Using the computer system for the first time

It is recommended that you save a copy of the original motherboard BIOS along with a Flash Memory Writer utility (AWDFLASH.EXE) to a bootable floppy disk in case you need to reinstall the BIOS later. AWDFLASH.EXE is a Flash Memory Writer utility that updates the BIOS by uploading a new BIOS file to the programmable flash ROM on the motherboard. This file works only in DOS mode. To determine the BIOS version of your motherboard, check the last four numbers of the code displayed on the upper left-hand corner of your screen during bootup. Larger numbers represent a newer BIOS file.

1. Type `FORMAT A:/S` at the DOS prompt to create a bootable system disk. DO NOT copy `AUTOEXEC.BAT` and `CONFIG.SYS` to the disk.
2. Type `COPY D:\AWDFLASH\AWDFLASH.EXE A:\` (assuming D is your CD-ROM drive) to copy `AWDFLASH.EXE` to the boot disk you created.



NOTE! AWDFLASH works only in DOS mode. It does not work in the DOS prompt within Windows, and does not work with certain memory drivers that may be loaded when you boot from the hard drive. It is recommended that you reboot using a floppy disk in order to open DOS mode.

3. Reboot the computer from the floppy disk. To use `AWDFLASH.EXE` must be operated from the ROOT directory. Therefore, copy the `AWDFLASH.EXE` program and the NEW BIOS file to the root directory on the hard disk drive; for example: type, “`COPY A:\AWDFLASH.EXE C:\`” and “`COPY A:\BIOSNAME.BIN C:\`”.



WARNING! If you encounter problems while updating the new BIOS, DO NOT turn off the system because this may cause boot problems. Just repeat the process, and if the problem persists, load the original BIOS file you saved to the boot disk, or try to clear the CMOS memory (see section 2.7, *Jumpers*). If the Flash Memory Writer utility is not able to successfully update a complete BIOS file, the system may not boot. If this happens, call the ASUS service center for support.

4.1.2 Updating BIOS procedures



CAUTION! Update the BIOS only if you have problems with the motherboard and you are sure that the new BIOS revision will solve your problems. Careless updating may create more problems !

The Binary Input/Output System (BIOS) can be updated using the built-in Flash Memory Writer utility or using a bootable floppy disk with the executable Flash Memory Writer Utility (AWDFLASH.EXE). The following sub-sections explain the steps in flashing your BIOS.

4.1.2.1 Updating BIOS via Built-in AwardBIOS Flash Utility

1. Download the latest BIOS file from the ASUS website (see ASUS contact info on Page viii). Save the copy to a floppy disk.



NOTE! Write down the BIOS file name on a piece of paper. You need to type the exact BIOS file name at the Award BIOS Flash Utility.

2. Reboot the computer.
3. To use AwardBIOS Flash Utility, press <Alt> + <F2> during POST to display the following screen.

```
AwardBIOS Flash Utility V8.20A
(C)Phoenix Technologies Ltd. All Rights Reserved

For nVidia-nForce-A7N8X      DATE: 08/13/2002
Flash Type - PMC Pm49FL004T LPC/FWH

File Name to Program : aw0702.bin

MacAddr: Safe=0000000000000000

Message: Do You Want To Save Bios (Y/N)
```



NOTE! The BIOS information in the above screen is for reference only. what you see on your screen may not be exactly the same as shown.

4. Insert the disk that contains the new BIOS file into the floppy drive. You will receive the error message, "WARNING! Device not ready!" if you proceed to step 5 without the disk in the drive.

5. Type the name of the new BIOS file, for example: "AW0702.BIN" then press <Enter>. The program asks if you want to save the previous BIOS. Select <Y> since it is advisable to back-up the original BIOS in case you need to reprogram it.
6. The program asks to save the previous BIOS to a separate file. Type a file name for the old bios and then press <Y>. The AWDFLASH program backs-up the file.

```
AwardBIOS Flash Utility V8.20A
(C)Phoenix Technologies Ltd. All Rights Reserved

For nVidia-nForce-A7N8X      DATE: 08/13/2002
Flash Type - PMC Pm49FL004T LPC/FWH

File Name to Program : aw0702.bin
Save current BIOS as : old.bin

Message: Press 'Y' to Program or 'N' to Exit
```

7. AWDFLASH proceeds to check the new BIOS file and asks the user to program (flash) the new BIOS file to the motherboard.

```
AwardBIOS Flash Utility V8.20A
(C)Phoenix Technologies Ltd. All Rights Reserved

For nVidia-nForce-A7N8X      DATE: 08/13/2002
Flash Type - PMC Pm49FL004T LPC/FWH

File Name to Program : aw0702.bin
Checksum : DAD6H
Save current BIOS as : old.bin

Message: Press 'Y' to Program or 'N' to Exit
```

8. Type <Y> and Press <Enter> to flash the new Bios file. NOTE: Do not shut off system power or unplug the supply during the flash process.

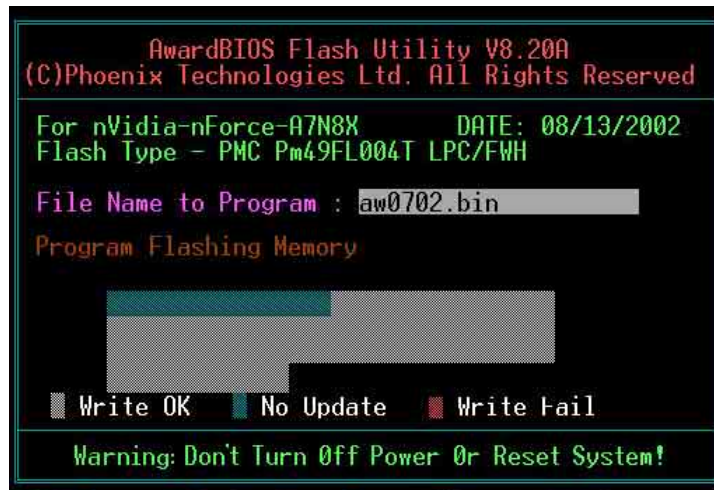

9. The BIOS flashes and displays the results. Press <F1> to restart.



4.1.2.2 Updating BIOS via Bootable Floppy Disk

1. Boot from the floppy disk.
2. At the "A:\>" prompt, type "C:\>" and then press <Enter>.
3. At the "C:\>" prompt, type "AWDFLASH /qi BIOSFILE" and then <Enter>. For example: "AWDFLASH /qi aw0702.bin" The AWDFLASH screen appears, and the BIOS file appears in the space, "File Name to Program".
4. Type the name of the new BIOS file, for example: "AW0702.BIN" then press <Enter>. The program asks if you want to save the previous BIOS. Select <Y> since it is advisable to back-up the original BIOS in case you need to reprogram it.
5. Follow steps 6 to 9 in "4.1.2.1 Updating BIOS via Built-in Award BIOS Flash Utility."

4.2 BIOS Setup program

This motherboard supports a programmable FLASH ROM that you can update using the provided utility described in section “4.1 Managing and updating your BIOS.”

Use the BIOS Setup program when you are installing a motherboard, reconfiguring your system, or prompted to “Run Setup”. This section explains how to configure your system using this utility.

Even if you are not prompted to use the Setup program, you may want to change the configuration of your computer in the future. For example, you may want to enable the security password feature or make changes to the power management settings. This requires you to reconfigure your system using the BIOS Setup program so that the computer can recognize these changes and record them in the CMOS RAM of the FLASH ROM.

The FLASH ROM on the motherboard stores the Setup utility. When you start up the computer, the system provides you with the opportunity to run this program. Press <Delete> during the Power-On Self Test (POST) to enter the Setup utility, otherwise, POST continues with its test routines.

If you wish to enter Setup after POST, restart the system by pressing <Ctrl> + <Alt> + <Delete>, or by pressing the reset button on the system chassis. You can also restart by turning the system off and then back on. Do this last option only if the first two failed.

The Setup program is designed to make it as easy to use as possible. It is a menu-driven program, which means you can scroll through the various sub-menus and make your selections among the predetermined choices.



NOTE! Because the BIOS software is constantly being updated, the following BIOS setup screens and descriptions are for reference purposes only, and may not exactly match what you see on your screen.

4.2.1 BIOS menu bar

The top of the screen has a menu bar with the following selections:

- MAIN** Use this menu to make changes to the basic system configuration.
- ADVANCED** Use this menu to enable and make changes to the advanced features, including BIOS, Chipset, Peripheral, Power and PnP/ PCI configurations.
- SECURITY** Use this menu to set the Supervisor and User passwords.
- HARDWARE** Monitor the status of vital components, including voltages and fan speeds.
- EXIT MONITOR** Use this menu to exit the current menu or to exit the Setup program.

To access the menu bar items, press the right or left arrow key on the keyboard until the desired item is highlighted.

4.2.2 Legend bar

At the bottom of the Setup screen is a legend bar. The keys in the legend bar allow you to navigate through the various setup menus. The following table lists the keys found in the legend bar with their corresponding functions.

Navigation Key(s)	Function Description
<F1>	Displays the General Help screen
<Esc>	Jumps to the Exit menu or returns to the main menu from a sub-menu
Left or Right arrow	Selects the menu item to the left or right
Up or Down arrow	Moves the highlight up or down between fields
Page Down and – (minus)	Scrolls backward through the values for the highlighted field
Page Up and + (plus)	Scrolls forward through the values for the highlighted field
<Enter>	Brings up a selection menu for the highlighted field
<F10>	Saves changes and Exit

General help

In addition to the Item Specific Help window, the BIOS setup program also provides a General Help screen. You may launch this screen from any menu by simply pressing <F1> or the <Alt> + <H> combination. The General Help screen lists the legend keys and their corresponding functions.

Saving changes and exiting the Setup program

See “4.7 Exit Menu” for detailed information on saving changes and exiting the setup program.

Scroll bar

When a scroll bar appears to the right of a help window, it indicates that there is more information to be displayed that will not fit in the window. Use <PgUp> and <PgDn> or the up and down arrow keys to scroll through the entire help document. Press <Home> to display the first page, press <End> to go to the last page. To exit the help window, press <Enter> or <Esc>.

Sub-menu

Note that a right pointer symbol (as shown on the left) appears to the left of certain fields. This pointer indicates that you can display a sub-menu from this field. A sub-menu contains additional options for a field parameter. To display a sub-menu, move the highlight to the field and press <Enter>. The sub-menu appears. Use the legend keys to navigate and enter values within each sub-menu as you would within a menu. Use the <Esc> key to return to the main menu. Take some time to familiarize yourself with the legend keys and their corresponding functions. Practice navigating through the various menus and sub-menus. While moving around through the Setup program, note that explanations appear in the Item Specific Help window located to the right of each menu. This window displays the help text for the currently highlighted field.

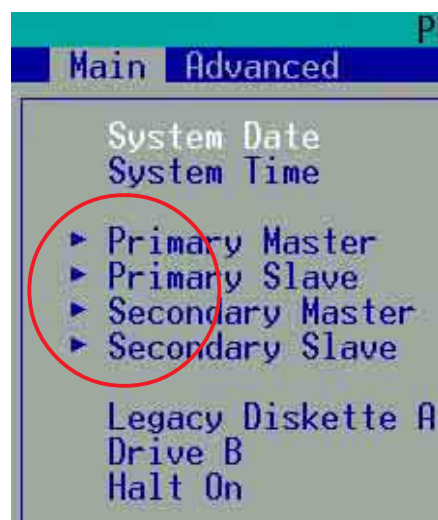

4.3 Main Menu

When you enter the Setup program, the following screen appears.

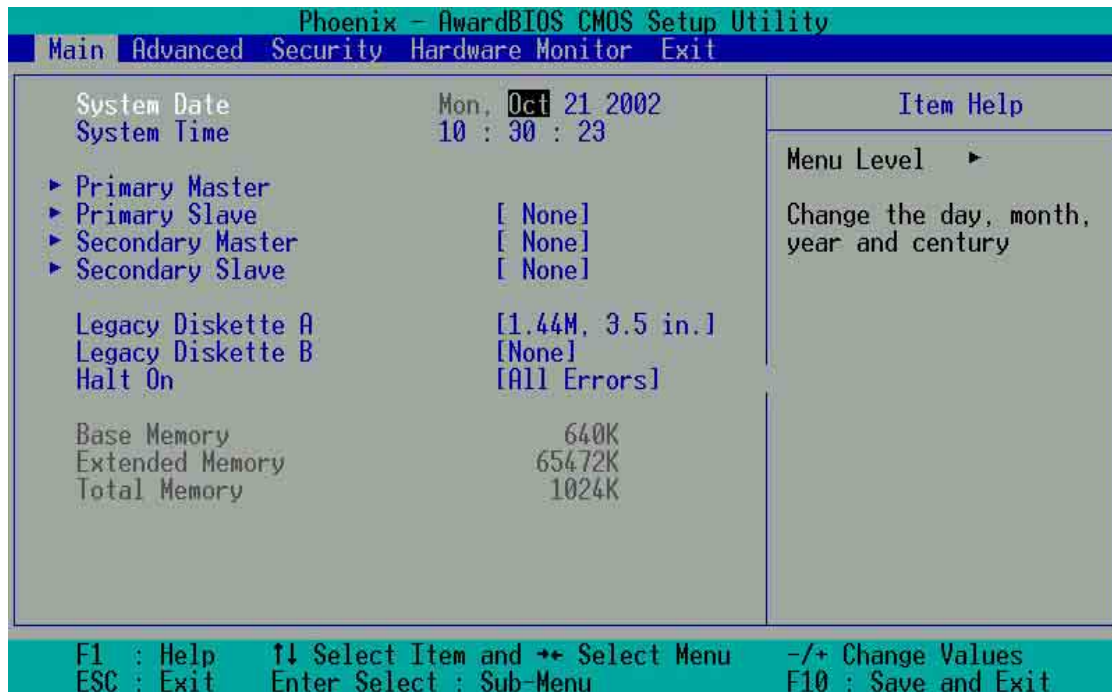

System Date [mm/dd/yy]

Sets the system to the date that you specify (usually the current date). The format is month, day, year. Valid values for month, day, and year are Month: (1 to 12), Day: (1 to 31), Year: (up to 2084). Use the <Tab> or <Shift> + <Tab> keys to move between the month, day, and year fields.

System Time [hh:mm:ss]

Sets the system to the time that you specify (usually the current time). The format is hour, minute, second. Valid values for hour, minute and second are Hour: (00 to 23), Minute: (00 to 59), Second: (00 to 59). Use the <Tab> or <Shift> + <Tab> keys to move between the hour, minute, and second fields.

Legacy Diskette A [1.44M, 3.5 in.]

Sets the type of floppy drive installed. Configuration options: [None] [360K, 5.25 in.] [1.2M , 5.25 in.] [720K , 3.5 in.] [1.44M, 3.5 in.] [2.88M, 3.5 in.]

Legacy Diskette B [None]

Sets the type of floppy drive installed. Configuration options: [None] [360K, 5.25 in.] [1.2M , 5.25 in.] [720K , 3.5 in.] [1.44M, 3.5 in.] [2.88M, 3.5 in.]

Halt On [All Errors]

This field sets the system to halt on errors according to the system functions specified in each option. Configuration options: [All Errors] [No Errors] [All, But Keyboard] [All , But Diskette] [All, But Disk/Key]

4.3.1 Primary Master/Slave

Phoenix - AwardBIOS CMOS Setup Utility	
Main	
Primary Master	Item Help
IDE HDD Auto-Detection [Press Enter]	Menu Level ▶▶
IDE Primary Master [Auto]	To auto-detect the HDD's size, head... on this channel
Access Mode [Auto]	
Capacity 0 MB	
Cylinder 0	
Head 0	
Precomp 0	
Landing Zone 0	
Sector 0	
F1 : Help ↑↓ Select Item and ↔ Select Menu -/+ Change Values ESC : Exit Enter Select : Sub-Menu F10 : Save and Exit	

IDE HDD Auto-Detection [Press Enter]

Press enter to automatically detect an IDE hard disk drive, if the hard drive is not already detected. In cases of undetected HDDs, pressing enter will detect the HDD and then open access to both the IDE Primary Master and Access Mode fields.

IDE Primary Master/Slave [Auto]

Select [Auto] to automatically detect an IDE hard disk drive. If automatic detection is successful, the setup BIOS automatically fills in the correct values for the remaining fields on this sub-menu. If automatic detection fails, this may be because the hard disk drive is too old or too new. If the hard disk was already formatted on a previous system, the setup BIOS may detect incorrect parameters. In these cases, select [Manual] to manually enter the IDE hard disk drive parameters. See *Access Mode* below and refer to the next page for more details. If no drive is installed or if you are removing a drive and not replacing it, select [None]. Configuration options: [None] [Auto] [Manual]

Access Mode [Auto]

The default [Auto] automatically detects an IDE hard disk drive. Select [CHS] in coordination with the [Manual] setting of the *IDE Primary Master* in order to enter the Hard Disk Drive values manually.



CAUTION! Before attempting to configure a hard disk drive, make sure you have the correct configuration information supplied by the drive manufacturer. Incorrect settings may cause the system to fail to recognize the installed hard disk.

[Manual] & [CHS] Settings

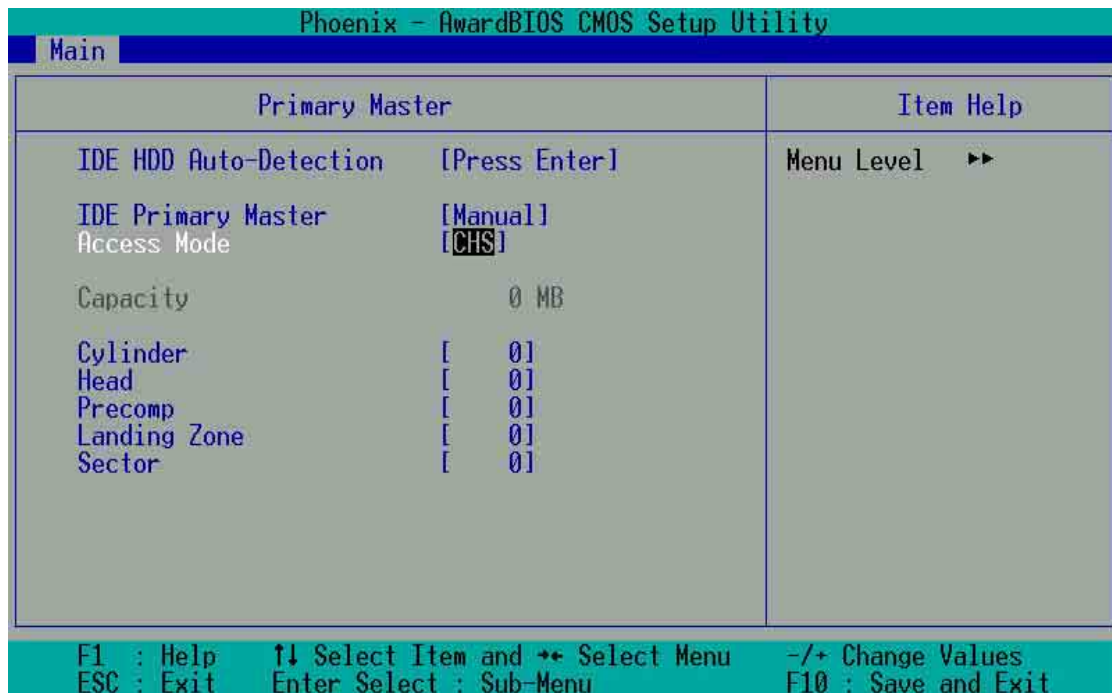

Manually enter the number of cylinders, heads and sectors per track for the drive. Refer to the drive documentation or on the drive label for this information.



NOTE! After entering the IDE hard disk drive information into BIOS, use a disk utility, such as FDISK, to partition and format new IDE hard disk drives. This is necessary so that you can write or read data from the hard disk. Make sure to set the partition of the Primary IDE hard disk drives to active.

After making your selections on this sub-menu, press the <Esc> key to return to the Main menu. When the Main menu appears, the hard disk drive field displays the size for the hard disk drive that you configured.

Access Mode [Auto]

Select the hard disk drive type in this field. When Logical Block Addressing (LBA) is enabled, the 28-bit addressing of the hard drive is used without regard for cylinders, heads, or sectors. Note that LBA Mode is necessary for drives with more than 504MB storage capacity. Select [CHS] to make manual entries for configuring the fields below. Configuration options: [CHS] [LBA] [Large] [Auto]

Cylinders

This field configures the number of cylinders. Refer to the drive documentation to determine the correct value. To make changes to this field, set the *IDE Primary Master* field to [Manual] and the *Access Mode* to [CHS].

Head

This field configures the number of read/write heads. Refer to the drive documentation to determine the correct value. To make changes to this field, set the *IDE Primary Master* field to [Manual] and the *Access Mode* to [CHS].

Precomp

This field displays the precompressed volumes on the hard disk, if any, in MB.

Landing Zone

This field displays the drive's maximum useable capacity as calculated by the BIOS based on the drive information you entered.

Sector

This field configures the number of sectors per track. Refer to the drive documentation to determine the correct value. To make changes to this field, set the *Type* field to [User Type HDD] and the *Translation Method* field to [Manual].

4.3.2 Secondary Master/Slave

Phoenix - AwardBIOS CMOS Setup Utility	
Main	
Secondary Master	Item Help
IDE HDD Auto-Detection [Press Enter]	Menu Level ▶▶
IDE Secondary Master Access Mode [Auto]	To auto-detect the HDD's size, head... on this channel
Capacity 0 MB	
Cylinder 0	
Head 0	
Precomp 0	
Landing Zone 0	
Sector 0	

F1 : Help ↑↓ Select Item and ↔ Select Menu -/+ Change Values
ESC : Exit Enter Select : Sub-Menu F10 : Save and Exit

IDE HDD Auto-Detection [Press Enter]

Press enter to automatically detect an IDE hard disk drive, if the hard drive is not already detected. In cases of undetected HDDs, pressing enter will detect the HDD and then open access to both the IDE Primary Master and Access Mode fields.

IDE Secondary Master/Slave [Auto]

Select [Auto] to automatically detect an IDE hard disk drive. If automatic detection is successful, the setup BIOS automatically fills in the correct values for the remaining fields on this sub-menu. If automatic detection fails, this may be because the hard disk drive is too old or too new. If the hard disk was already formatted on a previous system, the setup BIOS may detect incorrect parameters. In these cases, select [Manual] to manually enter the IDE hard disk drive parameters. See *Access Mode* below and refer to the next page for more details. If no drive is installed or if you are removing a drive and not replacing it, select [None]. Configuration options: [None] [Auto] [Manual]

Access Mode [Auto]

The default [Auto] automatically detects an IDE hard disk drive. Select [CHS] in coordination with the [Manual] setting of the *IDE Primary Master* in order to enter the Hard Disk Drive values manually.



CAUTION! Before attempting to configure a hard disk drive, make sure you have the correct configuration information supplied by the drive manufacturer. Incorrect settings may cause the system to fail to recognize the installed hard disk.

4.4 Advanced Menu

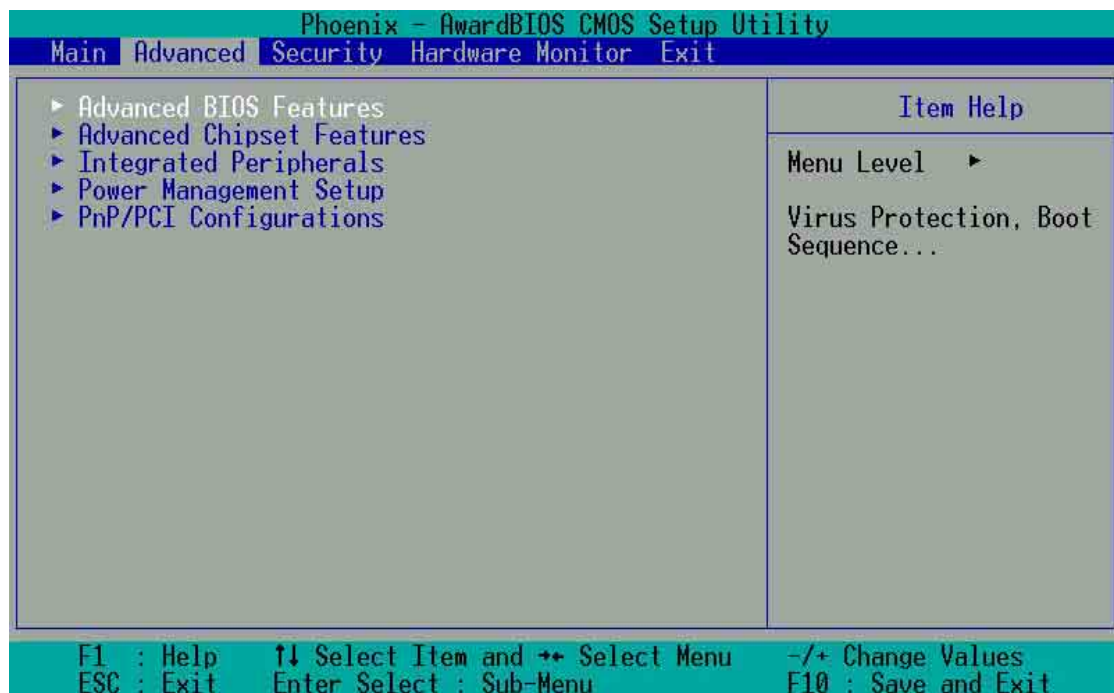

Advanced menu items

The Advanced menu accesses five important sub-menus:

Advanced BIOS Features

These fields set the functional properties of CPU caches, as well as boot devices, security and operational modes.

Advanced Chipset Features

These fields set chipset and CPU functions, including system and AGP caches, boot devices, memory settings, voltages and frequencies.

Integrated Peripherals

These fields set the functional properties of the IDE channels, Master/Slave PIOs, USB, IEEE 1394, audio, network and modem support, as well as serial, game, midi and parallel addresses.

Power Management Setup

These fields set the functional properties of the ACPI, system power management, HDD power, network “wake-up” and “power-on” options.

PnP/PCI Configuration

These fields set the capacity of the BIOS to reset data configurations and to automatically configure the system along with PCI/VGA properties. IRQ resources are accessed from this menu.

To access the menu bar items, press the up and down arrow keys and then press <enter> to view the desired menu.

4.4.1 Advanced BIOS Features

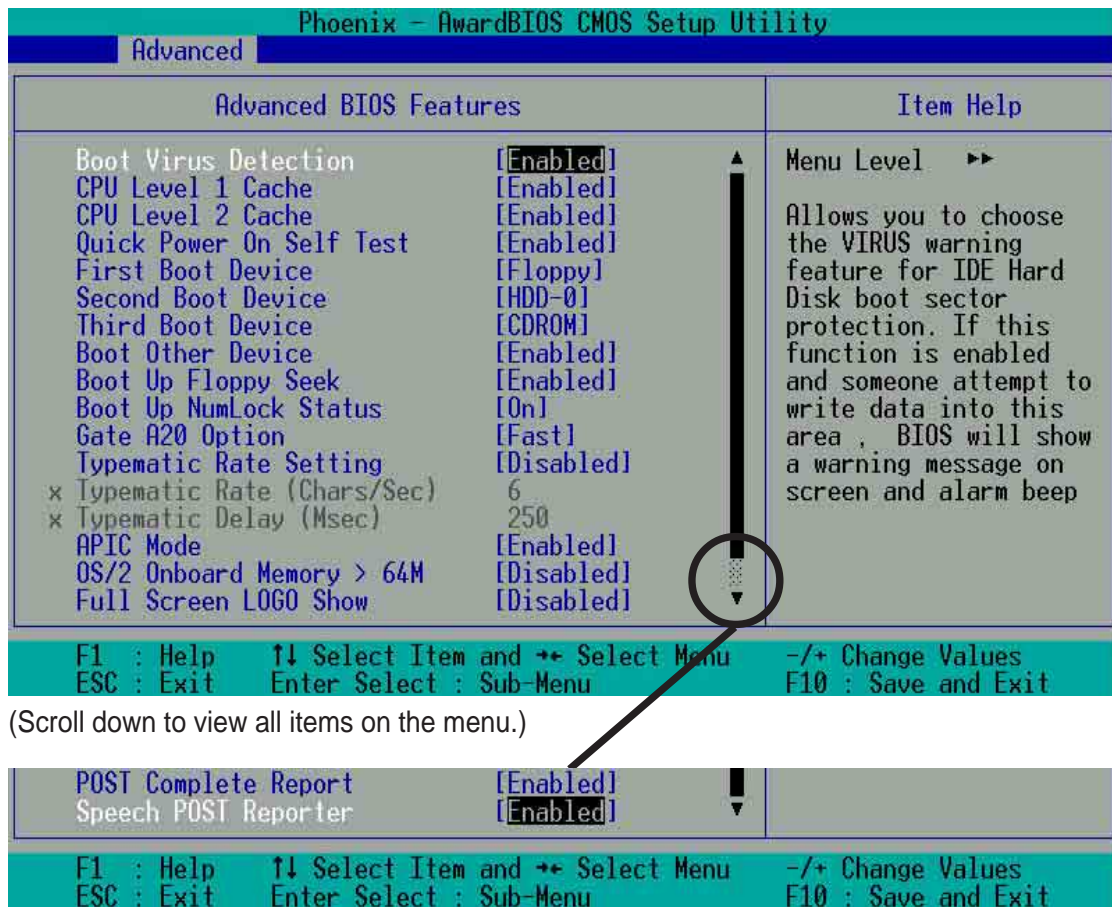

Boot Virus Detection [Disabled]

This field enables boot virus protection by default. Configuration options: [Enabled] [Disabled]

CPU Level 1 Cache [Enabled]

This field enables the CPU level 1 cache by default. Configuration options: [Enabled] [Disabled]

CPU Level 2 Cache [Enabled]

This field enables the level 2 cache by default. Configuration options: [Enabled] [Disabled]

Quick Power On Self Test [Enabled]

This field enables the power on test. Configuration options: [Enabled] [Disabled]

First Boot Device [Floppy]

This field sets the priority of the first boot device; by default, the system boots up on the floppy diskette drive. Configuration options: [Floppy] [LS120] [HDD] [SCSI] [CDROM] [ZIP100] [LAN] [Disabled]

Second Boot Device [HDD]

This field sets the priority of the second boot device; by default, the system boots up on the hard disk driver if the floppy drive is not present. Configuration options: [Floppy] [LS120] [HDD] [SCSI] [CDROM] [ZIP100] [LAN] [Disabled]

Third Boot Device [LS120]

This field sets the priority of the third boot device; by default, the system boots up on the LS120 if the floppy and hard disk drive are not present. Configuration options: [Floppy] [LS120] [HDD] [SCSI] [CDROM] [ZIP100] [LAN] [Disabled]

Boot Other Device [Enabled]

By default, this field enables the detection of other devices, aside from the first three priority devices. Configuration options: [Enabled] [Disabled]

Boot-up Floppy Seek [Enabled]

If enabled, this field speeds up the Power On Self Test (POST) routine by skipping and retesting a second, third and fourth time. Configuration options: [Enabled] [Disabled]

Boot-up NumLock Status [On]

This field sets the capability of the NumLock light/key to display/activate the system. Configuration options: [On] [Off]

Gate A20 Option [Fast]

This field sets the gate A20 rate. The default is [Fast]. Configuration options: [Normal] [Fast]

Typematic Rate Setting [Disabled]

This field enables or disable permission to change the rate of keystroke registration and display. By default, the rate cannot be changed. Change to [Enabled] to make settings in the nextt field. Configuration options: [Enabled] [Disabled]

Typematic Rate Setting (Char/Sec) [6]

This field determines the number of keystrokes per second that the system can register. Configuration options: [6] [8] [10] [12] [15] [20] [24] [30]

Typematic Delay (Msec) [250]

This field determines the delay time (in milliseconds) between registering a keystroke and displaying it onscreen. Configuration options: [250] [500] [750] [1000]

APIC Mode [Enabled]

This field enables or disables the APIC mode. Configuration options: [Enabled] [Disabled]

OS/2 Onboard Memory > 64MB [Disabled]

This field enables or disables the 64MB onboard memory set for OS/2.
Configuration options: [Disabled] [Enabled]

Full Screen LOGO Show [Enabled]

This field enables or disables display of the full screen logo for environmental protection, which is disabled by default.

Configuration options: [Enabled] [Disabled]

POST Complete Report [Enabled]

This field enables or disables display of the Power On Self Test (POST) complete report, which is [Enabled] by default.

Configuration options: [Enabled] [Disabled]

Speech POST Reporter [Enabled]

This field enables or disables the ASUS POST Reporter™ feature.

Configuration options: [Enabled] [Disabled]

4.4.2 Advanced Chipset Features

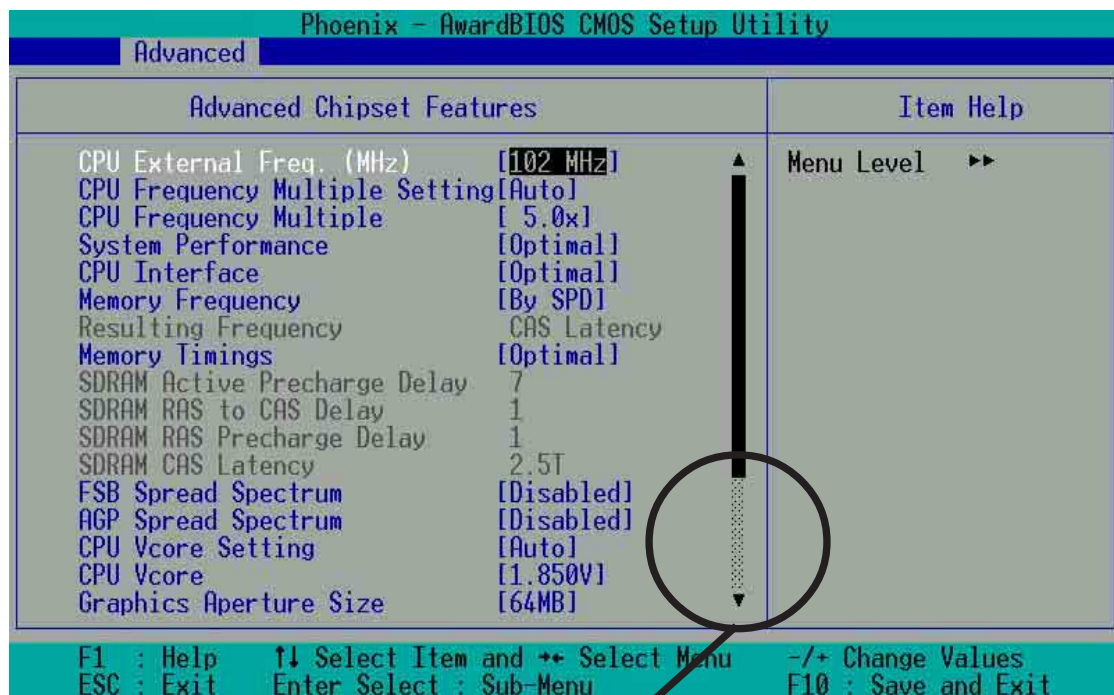

(Scroll down to view all items on the menu.)

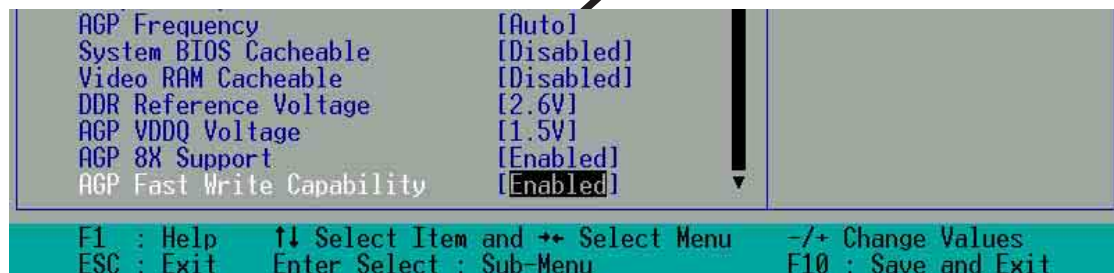

CPU External Frequency (MHz) [100MHz]

This field sets the external frequency ratio of the CPU. The system normally auto-detects the frequency capability based on the type of CPU installed. The Front Side Bus (FSB) is equal to 2 times this field value. Frequency ranges are adjustable in increments of 1, 2, 3 and/or 5 MHz. Configuration options: [100 MHz]... [200 MHz] [204 MHz] [207 MHz] [211 MHz]

CPU Frequency Multiple Setting [Auto]

This field sets the frequency multiple between the CPU's internal frequency (CPU speed) and external frequency. Set this field in conjunction with CPU Frequency (MHz) to match the speed of the CPU.

CPU Frequency Multiple [5.0x]

This field is available to unlocked processors only. For unlocked processors, this field sets the frequency multiple between the CPU's *internal* frequency (CPU speed) and the *external* frequency. Configuration options: [5.0x] [5.5x]... [11.5] [12.0] [12.5x/13.0x]

System Performance [Optimal]

This field permits change of mode for system performance. When set to [Optimal], the system uses the most stable settings. When you want to use overclocked settings for higher performance but with higher risk of instability, set to [Aggressive] and to allow full customization of performance options set to [Expert]. Configuration options: [Optimal] [Aggressive] [User Defined]

CPU Interface [Optimal]

This field sets the mode for CPU/FSB parameters usage. Select [Aggressive] if you want to use overclocked CPU/FSB parameters. Otherwise, the default value is [Optimal] where it uses the most stable CPU/FSB parameters. Configuration options: [Optimal] [Aggressive]

Memory Frequency [By SPD]

This field sets the type of memory frequency based on the type of DDR (Double Date Rate) memory module installed. Resulting frequency can vary depending on percentage setting which is multiplied by the FSB frrequency. Normally, the default, by SPD, permits autodetection. Configuration options: [By SPD] [50%] [60%] [66%] [75%] [80%] [83%] [Sync] [120%] [125%] [133%] [150%] [166%] [200%]

Resulting Frequency

This field displays the resulting memory frequency.

Memory Timing [Optimal]

This field permits change of memory timing mode for system performance. When set to [User Defined], the next four fields can be set manually. Set to [Aggressive] for higher performance. Use default [Optimal] to use most stable settings. Configuration options: [Optimal] [Aggressive] [User Defined]

SDRAM Active Precharge Delay [7]

Row-active delay.

SDRAM RAS to CAS Delay [1]

RAS-to-CAS. This item controls the latency between the SDRAM Active command to the SDRAM.

SDRAM RAS Precharge Delay [1]

Row-precharge delay.

SDRAM CAS Latency [2.5T]

This field sets the override clock cycle for the latency time between the SDRAM read command and the moment that the data actually becomes available. Normally, the system determines the rate automatically by default.

FSB Spread Spectrum [Disabled]

Configuration options: [Disabled] [0.50%] [1.00%]

AGP Spread Spectrum [Disabled]

Configuration options: [Disabled] [0.50%] [1.00%]

CPU Vcore Setting [Auto]

This field determines if the CPU Vcore is automatically scaled or set manually by the user. The default for this field is [Auto], therefore, the CPU vcore voltage is set for maximum performance without stressing the CPU. Configuration options: [Auto] [Menu]

CPU Vcore [1.850V]

When the CPU VCore Setting parameter is set to [Manual], this field permits selection of specific CPU core voltages. This field is not accessible if the above *CPU VCore Setting* parameter is set to [Auto]. Configuration options: [1.100V] [1.125V] ... [1.825] [1.850V]

Graphics Aperture Size [64M]

This field sets the size of mapped memory (in megabytes) for AGP graphic data. Configuration options: [32M] [64M] [128M] [256M] [512M]

AGP Frequency [Auto]

This field sets the frequency of the AGP controller. The default, [Auto], permits automatic selection of optimal AGP frequencies. Configuration options: [50, 66, 67, 68, 69, 70, 71, 72, 73, 74, 75, 76, 77, 78, 79, 80, 81, 82, 83, 84, 85, 86, 87, 90, 93, 95, 97, 100MHz]

System BIOS Cacheable [Disabled]

This field establishes whether or not the BIOS is cacheable. Disabled by default. Configuration options: [Enabled] [Disabled]

Video RAM Cacheable [Disabled]

This field establishes whether or not the video RAM is cacheable. Disabled by default. Configuration options: [Enabled] [Disabled]

DDR Reference Voltage [2.6V]

This field sets the voltage limits for the voltage supplied to the DDR memory. Note that increasing voltage to the DDR can cause premature failure of system components. Configuration options: [2.6V] [2.7V] [2.8V]

AGP VDDQ Voltage [1.5V]

This field sets the voltage limits for the voltage supplied to the AGP controller. Note that increasing voltage to the AGP controller can cause premature failure of system components.

Configuration options: [1.5V] [1.6V] [1.7V]

AGP 8X Support [Enabled]

This field enables or disables the AGP 8X support.

Configuration options: [Disable] [Enable]

AGP Fast Write Capability [Enabled]

This field enables or disables the AGP Fastwrite function.

Configuration options: [Disable] [Enable]

4.4.3 Integrated Peripherals

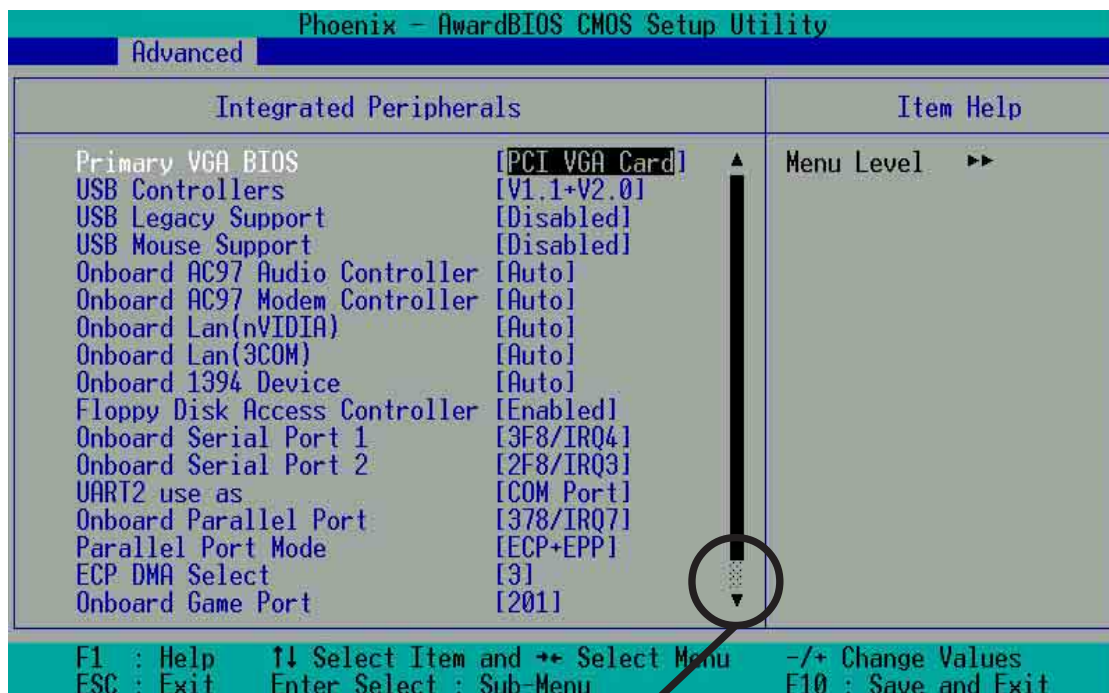

(Scroll down to view all items on the menu.)

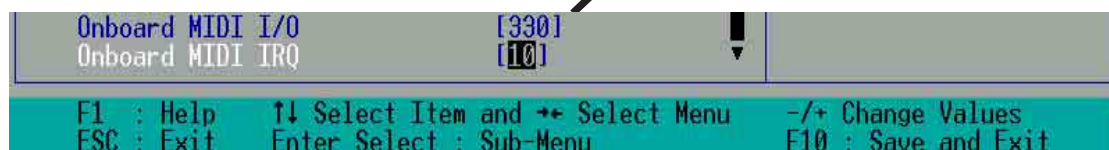

Primary VGA BIOS [PCI VGA Card]

This field sets the priority for the display of VGA signals. Change from the PCI VGA Cardt default to AGP VGA Card if using an AGP card.

Configuration options: [PCI VGA Card] [AGP VGA Card]

USB Controllers [V1.1+V2.0]

This field sets the protocols for OnChip processing of USB outputs. The default accomodates USB protocols 1.0 and 2.0. Configuration options:

[Disabled] [V1.1 +V2.0] [V1.1]

USB Legacy Support [Disabled]

This field sets support for USB keyboards0. The USB keyboard is disabled by default. Enable this field to use a USB keyboard. Configuration options: [Enabled] [Disabled]

USB Mouse Support [Disabled]

This field sets support for USB keyboards0. The USB keyboard is disabled by default. Enable this field to use a USB keyboard. Configuration options: [Enabled] [Disabled]

Onboard AC97 Audio Controller [Auto]

This field permits auto selection of AC97 audio codec processing by default. Configuration options: [Auto] [Disabled]

Onboard AC97 Modem Controller [Auto]

This field permits auto selection of AC97 modem support by default. Configuration options: [Auto] [Disabled]

Onboard Lan (nVIDIA) [Auto]

This field permits auto selection of MAC Lan (nVidia) support by default. Configuration options: [Auto] [Disabled]

Onboard Lan (3COM) [Auto]

This field permits auto selection of MAC lan (3COM) ethernet. Configuration options: [Auto] [Disabled]

Onboard 1394 Device [Enabled]

This field sets the on chip support for IEEE 1394 signal outputs by default. Configuration options: [Enabled] [Disabled]

Floppy Disk Access Controller [Enabled]

This field enables the FDA Controller by default. Configuration options: [Enabled] [Disabled]

Onboard Serial Port 1 [3F8/IRQ4]

These fields set the addresses for onboard serial port 1. Serial Port 1 and Serial Port 2 must have different addresses. Configuration options: [Disabled] [3F8/IRQ4] [2F8/IRQ3] [3E8/IRQ4] [2E8/IRQ3] [Auto]

Onboard Serial Port 2 [2F8/IRQ3]

These fields set the addresses for onboard serial port 2. Serial Port 1 and Serial Port 2 must have different addresses. Configuration options: [Disabled] [3F8/IRQ4] [2F8/IRQ3] [3E8/IRQ4] [2E8/IRQ3] [Auto]

UART use as [COM Port]

This field selects the device assignment for UART2 mode. The default is [COM Port]. Select [IR] to activate the next field, "UR2 Duplex Mode". Configuration options: [IR] [COM Port]

Onboard Parallel Port [378/IRQ7]

This field sets the address of the onboard parallel port connector to 378/IRQ7 by default. Disabling the port makes the parallel port unavailable. Configuration options: [Disabled] [378/IRQ7] [278/IRQ5] [3BC/IRQ7]

Parallel Port Mode [SPP]

This field sets the operation mode of the parallel port. The default, SPP, enables normal-speed operation but in one direction only; EPP enables bidirectional parallel port operation; ECP enables the parallel port to operate in bidirectional DMA mode; ECP+EPP enables normal speed operation in a both ECP and EPP modes. Select [ECP] to access the next field, "ECP Mode Use DMA". Configuration options: [SPP] [EPP] [ECP] [ECP +EPP]

ECP DMA Select [3]

This field sets the parallel port DMA channel for the selected ECP mode. The default setting is 3. This selection is available only if you select [ECP] or [ECP+EPP] in Parallel Port Mode above. Configuration options: [1] [3]

Onboard Game Port [201]

This field sets the address of the game port to 201 by default. Disabling the game port makes the port unavailable.

Configuration options: [Disabled] [201] [209]

Onboard MIDI I/O [330]

This field sets the address of the MIDI I/O port to 330 by default.

Configuration options: [Disabled] [330] [300]

Onboard MIDI IRQ [10]

This field sets the IRQ address of the MIDI port to 10 by default.

Configuration options: [5] [10]

4.4.4 Power Management Setup

Phoenix - AwardBIOS CMOS Setup Utility	
Advanced	
Power Management Setup	Item Help
ACPI Suspend to RAM	[Disabled]
Video Off Method	[DPMS Support]
HDD Down In Suspend	[Disabled]
PWR button < 4 Secs	[Soft Off]
Power Up On PCI Device	[Enabled]
Wake/Power Up On Ext.Modem	[Disabled]
Automatic Power Up	[Disabled]
x Time(hh:mm:ss) of Alarm	0 : 56 : 0
AC Power Loss Restart	[Disabled]
Power On By PS/2 Mouse	[Disabled]
Power On By PS/2 Keyboard	[Disabled]

F1 : Help	↑↓ Select Item and →← Select Menu	-/+ Change Values
ESC : Exit	Enter Select : Sub-Menu	F10 : Save and Exit

ACPI Suspend to RAM [Disabled]

This field enables or disables suspension to RAM. Configuration options: [Enabled] [Disabled]

Video Off Method [DPMS Support]

This field defines “video off” features. The DPMS support option (Display Power Management System) permits the BIOS to control the video display card if it supports the DPMS feature. Blank Screen option blanks the screen; use blank screen for monitors without power management or “green” features. [V/H SYNC+Blank] blanks the screen and turns off vertical and horizontal scanning. Configuration options: [Blank Screen] [V/H SYNC+Blank] [DPMS Support]

HDD Down In Suspend [Disabled]

This field sets whether or not the HDD is automatically shut down in suspend mode. The default disables power to the HDD in suspend mode. Configuration options: [Enabled] [Disabled]

PWR button < 4 Secs [Suspend]

This field sets the delay after which the system powers off after depressing the external case-mounted power button. The default setting powers off the system instantly. Configuration options: [Soft-Off] [Suspend]

Power Up on PCI Device [Enabled]

This field enables Wake-On-LAN from soft-off mode. The default disables this option. Configuration options: [Enabled] [Disabled]

Wake-Power Up On Ext. Modem [Disabled]

This field allows either settings of [Enabled] or [Disabled] for powering up the computer when the external modem receives a call while the computer is in Soft-off mode. Configuration options: [Enabled] [Disabled]

Automatic Power Up [Disabled]

This field sets to enable or disable the automatic power up. When [Enabled] the **Time (hh:mm:ss) of Alarm** field is enabled for input.

Configuration options: [Enabled] [Disabled]

Time (hh:mm:ss) of Alarm 0:00:00

This field sets the time for automatic power up. Enter the hour, minute and second based on the 24 hour clock. The Automatic Power Up field must be enabled to use this feature.

AC Power Loss Re-Start [Disabled]

This allows you to set whether or not to reboot the system after power interruptions. [Disabled] leaves your system off while [Enabled] reboots the system. [Previous State] sets the system back to the state it was before the power interruption. Configuration options: [Disabled] [Enabled]

[Previous State]

Power On By PS/2 Mouse [Disabled]

When set to [Enabled], this parameter allows you to use the PS/2 mouse to turn on the system. This feature requires an ATX power supply that provides at least 1A on the +5VSB lead. Configuration options: [Disabled] [Enabled]

Power On By PS/2 Keyboard [Disabled]

This parameter allows you to use specific keys on the keyboard to turn on the system. This feature requires an ATX power supply that provides at least 1A on the +5VSB lead. Configuration options: [Disabled] [Any KEY]

[Power Key]

4.4.5 PnP / PCI Configurations

Phoenix - AwardBIOS CMOS Setup Utility	
Advanced	
PnP/PCI Configurations	Item Help
Reset Configuration Data [Disabled]	Menu Level ▶▶
Resources Controlled By [Auto(ESCD)] x IRQ Resources	Default is Disabled. Select Enabled to reset Extended System Configuration Data (ESCD) when you exit Setup if you have installed a new add-on and the system reconfiguration has caused such a serious conflict that the OS cannot boot
PCI/VGA Palette Snoop [Disabled]	
F1 : Help ↑↓ Select Item and → Select Menu	-/+ Change Values
ESC : Exit Enter Select : Sub-Menu	F10 : Save and Exit

Reset Configuration Data [Disabled]

The Extended System Configuration Data (ESCD) contains information about non-PnP devices. It also holds the complete record of how the system was configured the last time it was booted. Enable this feature if you want to clear data during the Power-On-Self-Test (POST). The default disables this feature. Configuration options: [Enabled] [Disabled]

Resources Controlled By [Auto(ESCD)]

This field sets control over the IRQ resources by the automatic (ESCD) system or manual assignment of IRQ channels. The default enables automatic (ESCD) control. Configuration options: [Auto(ESCD)] [Manual]

NOTE: Selecting Manual access the IRQ Resources sub-menu; see the next page.

PCI/VGA Palette Snoop [Disabled]

This field enables the PCI/VGA palette snoop. This feature is disabled by default. Configuration options: [Enabled] [Disabled]

4.5 Security Menu

The BIOS Setup program permits two different passwords to control access to the BIOS during system startup: a Supervisor password and a User password. Passwords are not case sensitive, meaning, passwords can be typed in either uppercase or lowercase letters. The table below describes the authority level when setting Supervisor or User Password.

TABLE 4.6.1 Supervisor/User Set Password

Security Option	Supervisor Password	User Password
System	A password is required for booting and entering into the CMOS setup and all items can be modified.	A password is required for booting and entering into the CMOS setup and only "Date" and "Time" could be modified. All other items in the CMOS are displayed only.
Setup	A password is required to enter into the CMOS and items can be modified.	A password is required to enter into the CMOS and only "Date" and "Time" could be modified. All other items in the CMOS are displayed only.

TABLE 4.6.2 User Set Password only

Security Option	Supervisor Password	User Password
System	None	A password is required for booting and entering into the CMOS setup and all items can be modified.
Setup	None	A password is required to enter into the CMOS setup and all items can be modified.

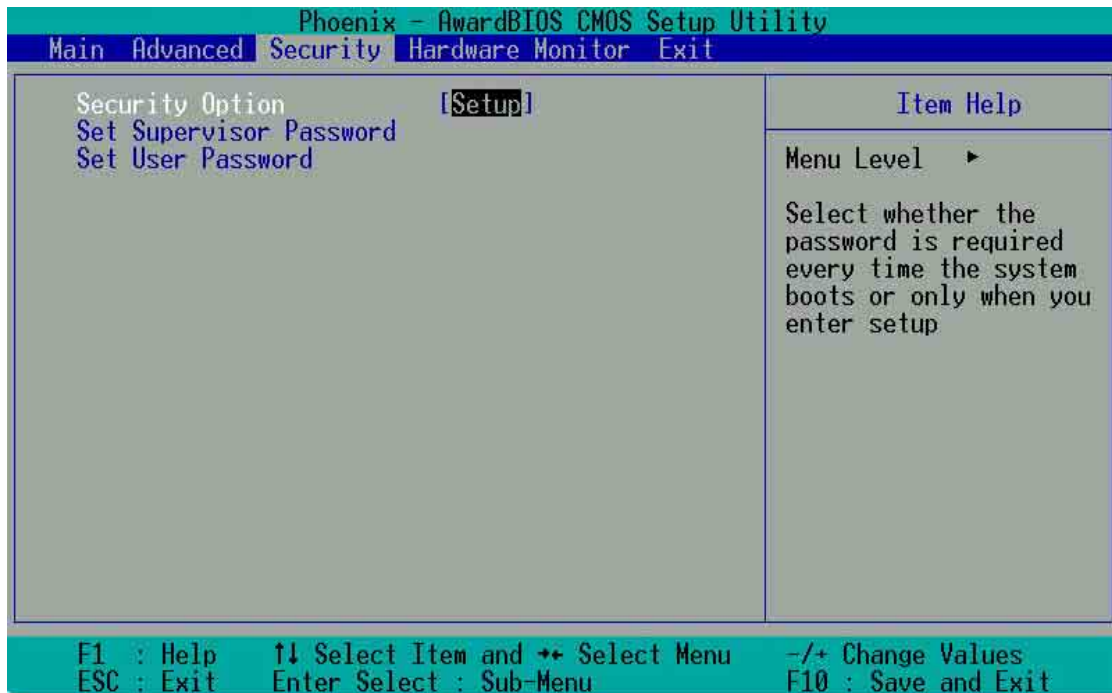

Security Option [Setup]

This field sets the security options. The default enables the setup option for security. Configuration options: [Setup] [System]

Set Supervisor Password / Set User Password

To set a password, highlight the appropriate field and press <Enter>. Type in a password then press <Enter>. You can type up to eight alphanumeric characters; symbols and other characters are not useable. To confirm the password, type the password again and press <Enter>. The password is now set to [Enabled]. This password permits full access to the BIOS Setup menus. To clear the password, highlight this field and press <Enter>. The same dialog box as above appears. Press <Enter>. The password is set to [Disabled].

Forgot the password?

If you forget a password, you can clear it by erasing the CMOS Real Time Clock (RTC) RAM. The RAM data containing the password information is powered by the onboard button cell battery.

NOTE: See section “2.7 Jumpers” for more information about how to erase the RTC RAM.

4.6 Hardware Monitor Menu

The Hardware Monitor menu displays all vital system statistics.

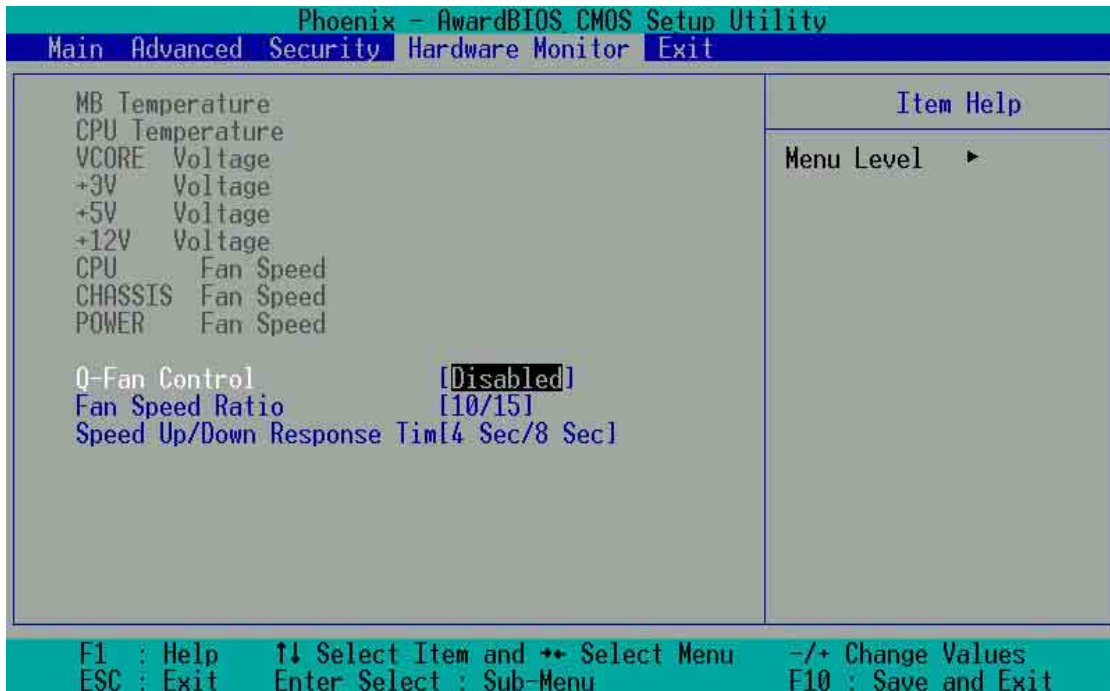

MB, CPU Temperature [xx C / xx F]

The onboard hardware monitor automatically detects the MB (motherboard) and CPU temperatures.

VCORE Voltage, +3.3V Voltage, +5V Voltage, +12V Voltage

The onboard hardware monitor automatically detects the voltage output through the voltage regulators.

CPU Fan Speed xxxx RPM or 0 RPM

CHASSIS Fan Speed xxxx RPM or 0 RPM

POWER Fan Speed xxxx RPM or 0 RPM

The onboard hardware monitor automatically detects the CPU, power and chassis fan speeds and displays the fan speeds in revolutions per minute (RPM). If any of the fans is not connected to the fan connectors on the motherboard, the specific field will show N/A.

Q-Fan Control [Disabled]

This field allows you to enable or disable the ASUS Q-Fan feature that smartly adjusts the fan speeds for more efficient system operation. When this field is set to [Enabled], set the appropriate **Fan Speed Ratio** and **Speed Up/Down Response Time**. Configuration options: [Disabled] [Enabled]

Fan Speed Ratio [10/15]

This item allows you to select the appropriate fan speed ratio for the system. The default [10/15] is the minimum fan speed ratio. Select a higher ratio if you installed additional devices and the system requires more ventilation. This item is required to be set when the Q-Fan Control field is [Enabled]. Configuration options: [10/15] [11/15] [12/15] [13/15] [14/15] [Full Speed].

Speed Up/Down Response Time [4 Sec/8 Sec]

This item indicates the time period before the fan speeds adjust to the value set in the **Fan Speed Ratio** field. This item is required to be set when the Q-Fan Control field is [Enabled]. Configuration options: [1 Sec/2 Sec] [2 Sec/4 Sec] [3 Sec/6 Sec] [4 Sec/8 Sec]

4.7 Exit Menu

After making all selections from the various menus in the Setup program, save the changes and exit Setup.

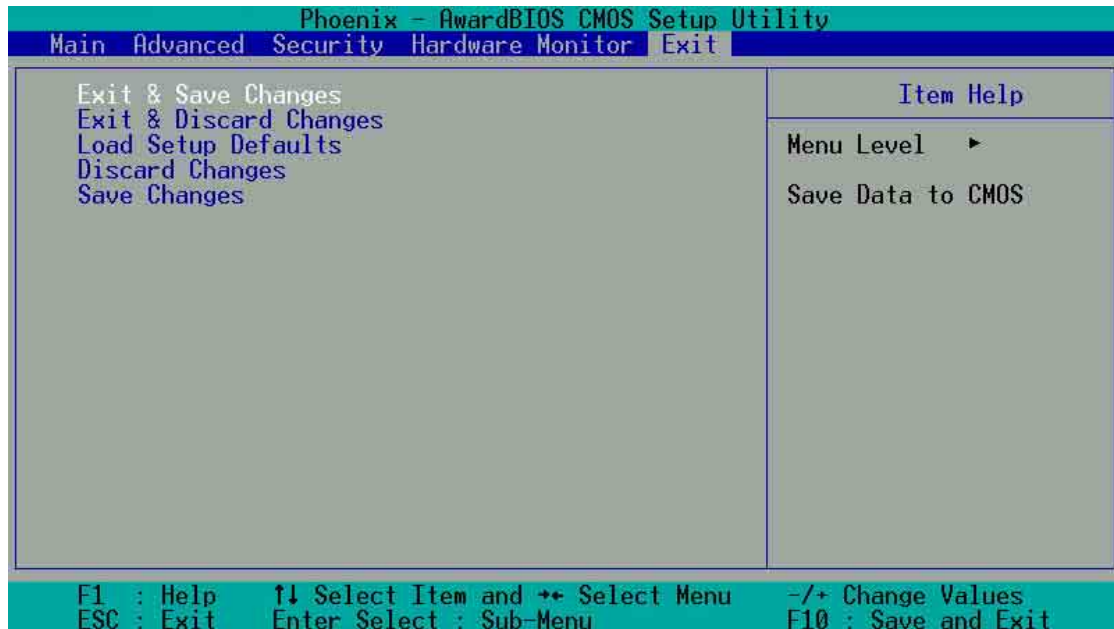

NOTE! Pressing <Esc> does not immediately exit this menu. Select one of the options from this menu or <F10> from the legend bar to exit.

Exit & Save Changes

Choose this option from the Exit menu to ensure the selected values are saved to the CMOS RAM. When selecting this option, a confirmation window appears. Select [Yes] to save changes and exit. The CMOS RAM is sustained by an onboard backup battery and stays on even when the PC is turned off.



NOTE! If attempting to exit the Setup program without saving changes, the program prompts with a message asking if you want to save your changes before exiting. Pressing <Enter> saves the changes while exiting.

Exit & Discard Changes

Select this option only if you do not want to save the changes that you made to the Setup program. If you made changes to fields other than system date, system time, and password, the BIOS asks for a confirmation before exiting.

Load Setup Defaults

This option allows you to load the default values for each of the parameters on the Setup menus. When you select this option, a confirmation window appears. Select [Yes] to load default values. Select Exit Saving Changes or make other changes before saving the values to the non-volatile RAM.

Discard Changes

This option allows you to discard the selections you made and restore the previously saved values. After selecting this option, a confirmation appears. Select [Yes] to discard any changes and load the previously saved values.

Save Changes

This option saves your selections without exiting the Setup program. You can then return to other menus and make further changes. After you select this option, a confirmation window appears. Select [Yes] to save any changes to the non-volatile RAM.

Chapter 5

Software support

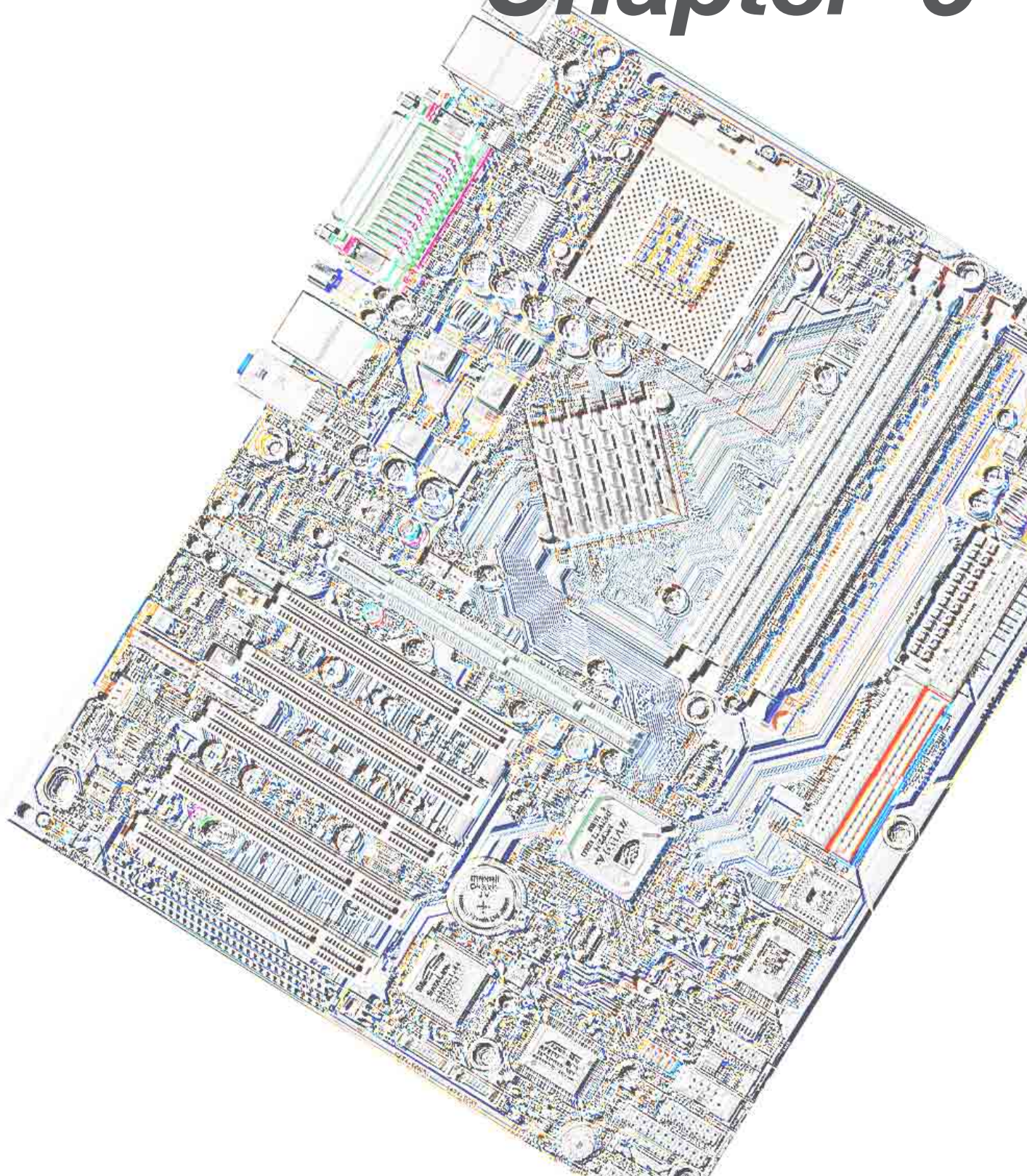

5.1 Install an operating system

This motherboard supports Windows 98/98SE/ME/ and 2000/XP operating system (OS). Always install the latest OS version and corresponding updates so you can maximize the features of your hardware.

5.1.1 Windows first time installation

When you start Windows for the first time after installing the motherboard, Windows 98 detects all Plug-n-Play devices. Follow the **Add New Hardware** wizard to install the necessary device drivers. When prompted to restart, select **No**. Refer to the following sections in this chapter to install the software and drivers contained in the support CD.



NOTE! Because motherboard settings and hardware options vary, use the setup procedures presented in this chapter for general reference only. Refer to your OS documentation for more information.

5.2 Support CD information

The support CD that came with the motherboard contains useful software and several utility drivers that enhance the motherboard features.



NOTE! The contents of the support CD are subject to change at any time without notice. Visit the ASUS website for updates.

5.2.1 Running the support CD

To begin using the support CD, simply insert the CD into your CD-ROM drive. The CD automatically displays the welcome screen and the installation menus if Autorun is enabled in your computer.

5.3 A7N8X Motherboard Support CD

NOTE: The support CD contents are subject to change without notice.

To begin using your support CD disc, just insert it into your CD-ROM drive and the support CD installation menu should appear. If the menu does not appear, double-click or run D:\ASSETUP.EXE.

5.3.1 Installation Procedure

Click on the name of the driver or program group to begin installation. Follow the instructions that appear on the setup screens. All drivers and programs install automatically. Refer to 6. *Software Reference* for operating instructions.

5.3.2 Available Installation Menus

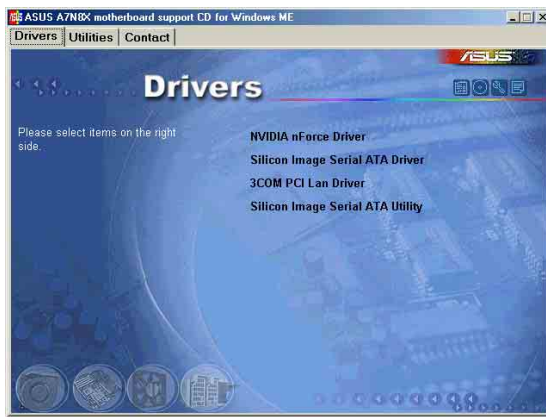

Drivers:

- **NVIDIA nForce Drivers:** Installs the NVIDIA nForce drivers.
- **Silicon Image Serial ATA driver:** Displays step-by-step installation information of Silicon Image Serial ATA driver for various operating systems.
- **3COM PCI Lan Driver:** Installs a driver for integrated 3COM LAN
- **Silicon Image Serial ATA Utility:** Install software utility to monitor and manipulate Silicon Image Serial ATA.



NOTE!

You may need to reboot the system more than once during installation.



IMPORTANT!

A. For Windows 98 users, perform the following steps before installing **NVIDIA nForce Drivers** from support CD.

1. Create a new directory in your disc drive C: and name it “Win98SRC”.
2. Copy all the files (excluding sub-directories) from “\Win98” folder of the Windows 98 CD to “C:\Win98SRC” folder.
3. When you install **NVIDIA nForce Drivers**, the system will ask for the “Windows 98 CD”, set the directory to “C:\Win98SRC”.

B. For Windows 98 and Windows ME users, perform the following steps before installing the **Silicon Image Serial ATA Utility**. If you are not using Serial ATA devices, DO NOT install **Silicon Image Serial ATA Utility** or your system may become unstable.

1. Connect the Serial ATA device.
 2. Install Silicon Image Serial ATA Utility from support CD.
 3. If you need to remove or disconnect any Serial ATA device, UNINSTALL **Silicon Image Serial ATA Utility** first.
-

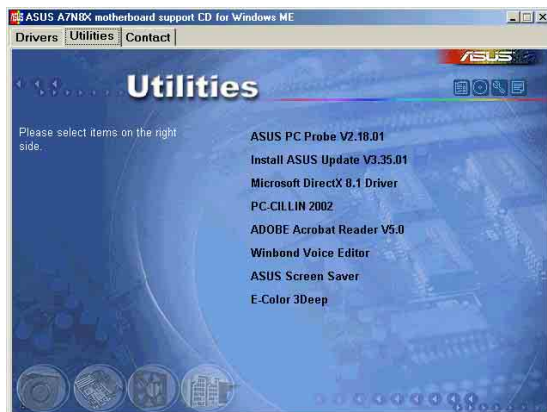

Utilities:

- **ASUS PC Probe:** Installs a smart utility to monitor your computer’s fan, temperature, and voltages.
- **Install ASUS Update:** Instals a program that can help you update BIOS or download a BIOS image file.
- **Microsoft DirectX Driver:** Installs basic drivers to enable compatibility with audio and other special functions.
- **PC-Cillin 2002:** Installs the latest PC-cillin virus protection software. View [online help](#) for more information.

- **ADOBE Acrobat Reader:** Installs the Adobe Acrobat Reader software necessary to view user's manuals saved in PDF format. Updated or other language versions of this motherboard's manual is available in PDF format at any of our web sites.
- **Winbond Voice Editor:** Installs a convenient utility to customize vocal POST messages. (optional)
- **ASUS Screen Saver:** Installs a nifty ASUS screen saver.
- **E-Color 3Deep:** Installs the 3Deep software. 3Deep is the first application that gives online games the competitive edge in multi-player skirmishes. this application removes dark washed-out graphics to deliver true vibrant colors.



Contact:

- A list of addresses, phone numbers and ASUS website locations.

5.4 ASUS PC Probe

ASUS PC Probe is a convenient utility to continuously monitor your computer system's vital components, such as fan rotations, Voltages, and temperatures. It also has a utility that lets you review useful information about your computer, such as hard disk space, memory usage, and CPU type, CPU speed, and internal/external frequencies through the DMI Explorer.

5.4.1 Starting ASUS PC Probe

When ASUS PC Probe starts, a splash screen appears allowing you to select whether or not to show the screen the next time you open PC Probe. To bypass this startup screen, clear the **Show up in next execution** check box.

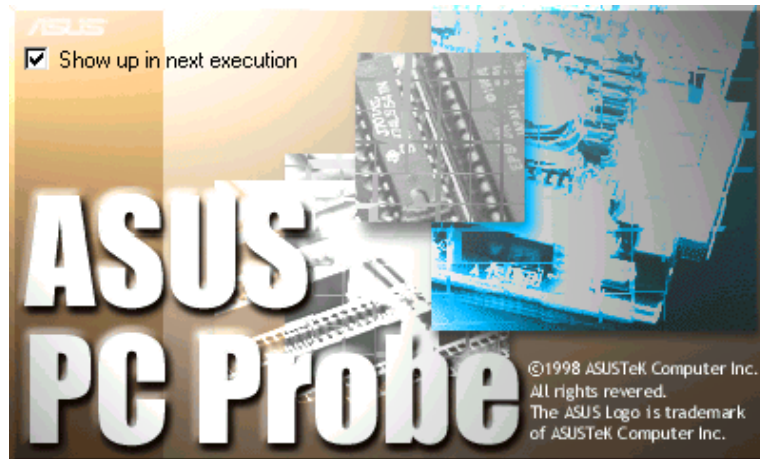

To start **ASUS PC Probe**, click the Windows **Start** button, point to **Programs**, and then **ASUS Utility**, and then click **Probe Vx.xx**.

The PC Probe icon  will appear on the taskbar's system tray indicating that ASUS PC Probe is running. Clicking the icon will allow you to see the status of your PC.

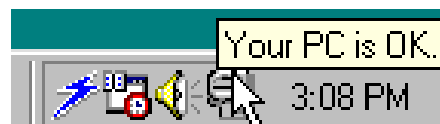

5.4.2 Using ASUS PC Probe

Monitoring

Monitor Summary

Shows a summary of the items being monitored.

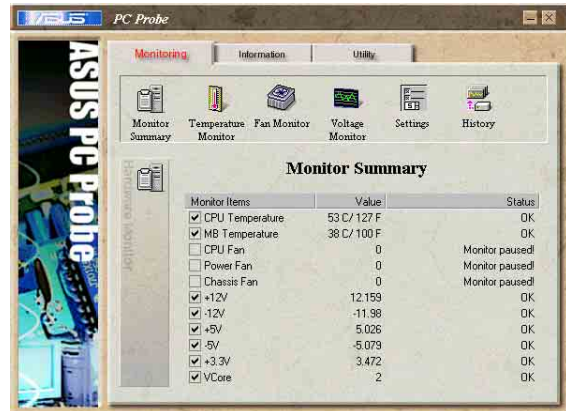

Temperature Monitor

Shows the PC's temperature.

Temperature Warning threshold adjustment
(Move the slider up to increase the threshold level or down to decrease the threshold level)

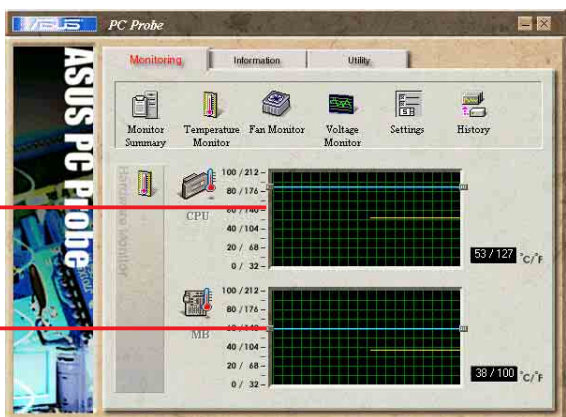

Fan Monitor

Shows the PC's fan rotation.

Fan Warning threshold adjustment
(Move the slider up to increase the threshold level or down to decrease the threshold level)

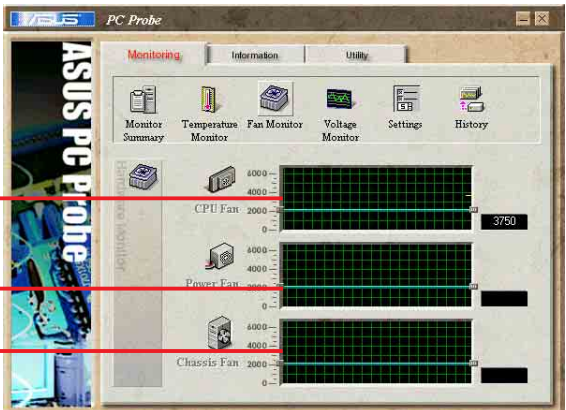

Voltage Monitor

Shows the PC's voltages.

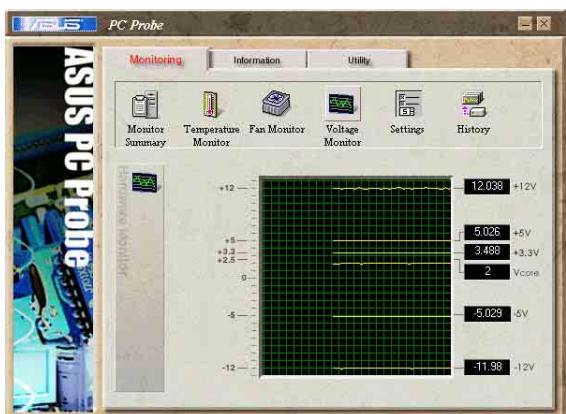

Settings

Lets you set threshold levels and polling intervals or refresh times of the PC's temperature, fan rotation, and voltages.

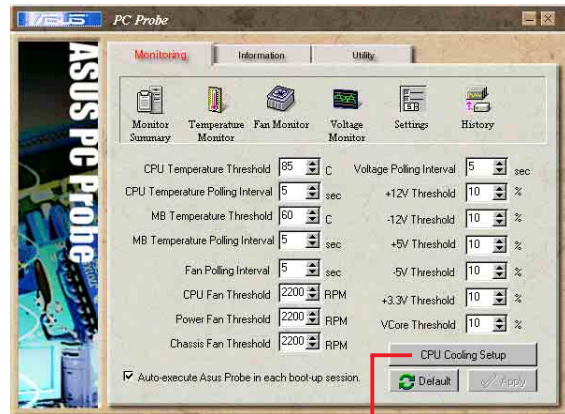

CPU Cooling System Setup

Lets you select when to enable software CPU cooling. When **When CPU Overheated** is selected, the CPU cooling system is enabled whenever the CPU temperature reaches the threshold value.



History

Lets you record the current monitoring activity of a certain component of your PC for future reference.

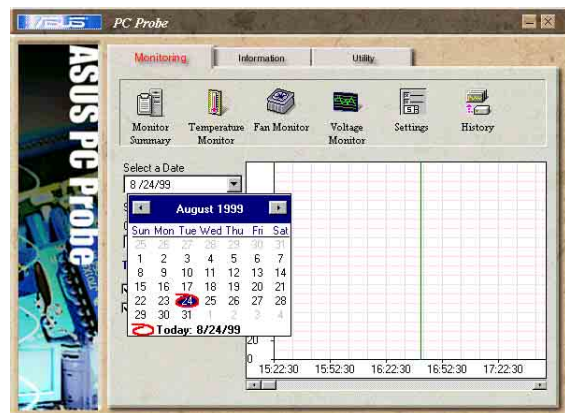

Information

Hard Drives

Shows the used and free space of the PC's hard disk drives and the file allocation table or file system used.



Memory

Shows the PC's memory load, memory usage, and paging file usage.

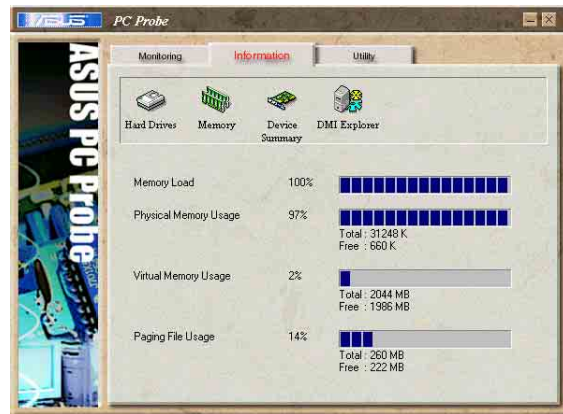

Device Summary

Shows a summary of devices in your PC.



DMI Explorer

Shows information pertinent to the PC, such as CPU type, CPU speed, and internal/external frequencies, and memory size.

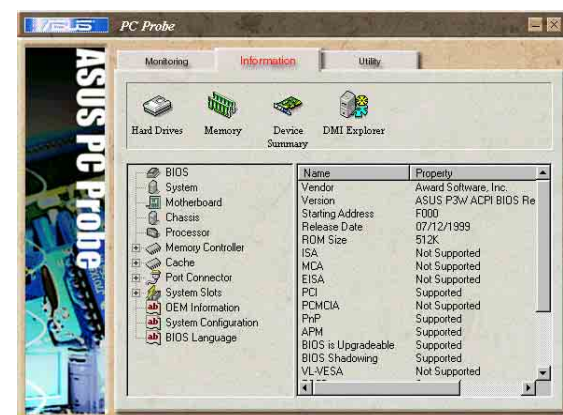

Utility

Lets you run programs outside of the ASUS Probe modules. To run a program, click **Execute Program**.

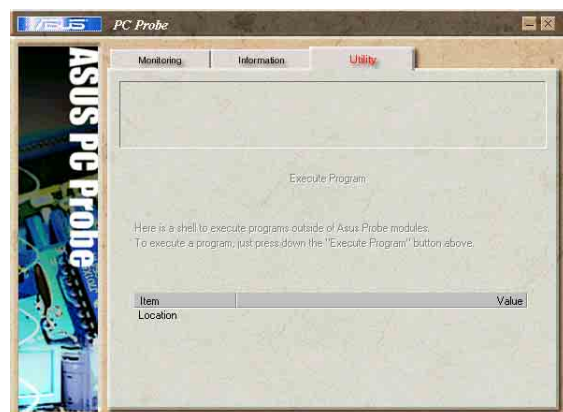

5.4.3 ASUS PC Probe Task Bar Icon

Right-clicking the PC Probe icon will bring up a menu to open or exit ASUS PC Probe and pause or resume all system monitoring.



When the ASUS PC Probe senses a problem with your PC, portions of the ASUS PC Probe icon changes to red, the PC speaker beeps, and the ASUS PC Probe monitor is displayed.

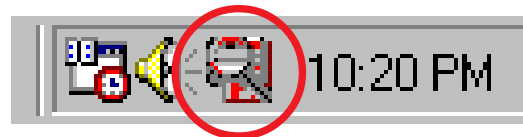

5.5 ASUS Live Update

ASUS LiveUpdate is a utility that allows you to update your motherboard's BIOS and drivers. The use of this utility requires that you are properly connected to the Internet through an Internet Service Provider (ISP).

1. Start ASUS Update. Launch the utility from your Windows Start menu: Programs/AsusUpdate.
2. Select an update method.

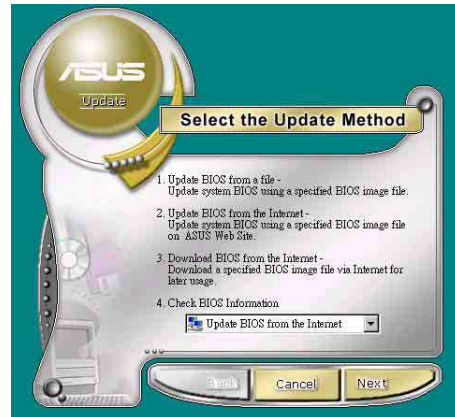

3. If you selected "downloading from the Internet," you will need to select an Internet site. Choose the site that is closest to you or click Auto Select.

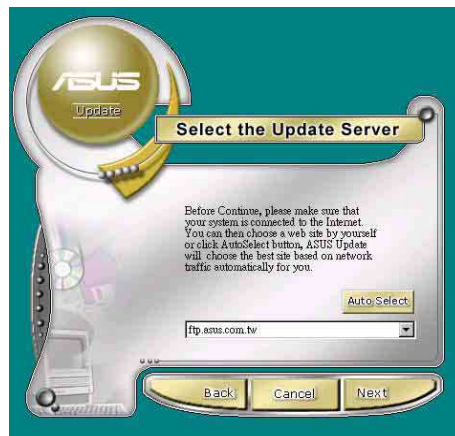

4. From the FTP site, select the BIOS version that you wish to download. Click Next.



5. Follow the instructions on the succeeding screens to complete the update process. If you selected the option to update the BIOS from a file, a window pops up prompting you to locate the file. Select the file, click Save, then follow the screen instructions to complete the update process.

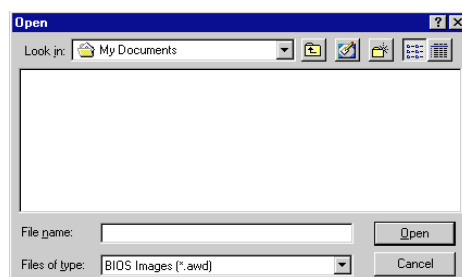

5.6 3Deep Color Tuner

The 3-Deep color tuner is designed to match your CRT or LCD color monitor to maximize the color quality of all graphical applications. Users may also tune their internet applications to match “true” internet source colors with the color displayed on the monitor.

Simply run the setup program from the start menu and follow the instructions on the various setup/test screens.

5.6.1 3Deep Color Tuning

1. Select the type of monitor connected to the computer, either **CRT** or **LCD**.



2. Follow the instructions to manually adjust the **brightness** level of the monitor.

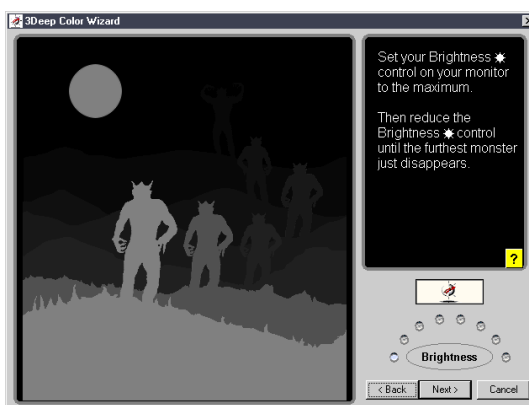

3. Select the faintest of the three colors: **blue**, **red** and **green**.

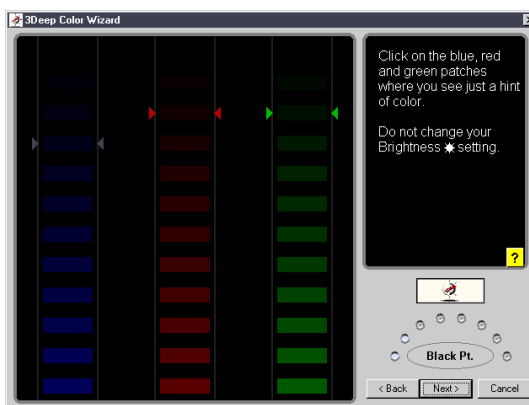

4. Select the color squares which most closely blend and match with the background.

5. The next step repeats the color matching process to achieve full color quality.

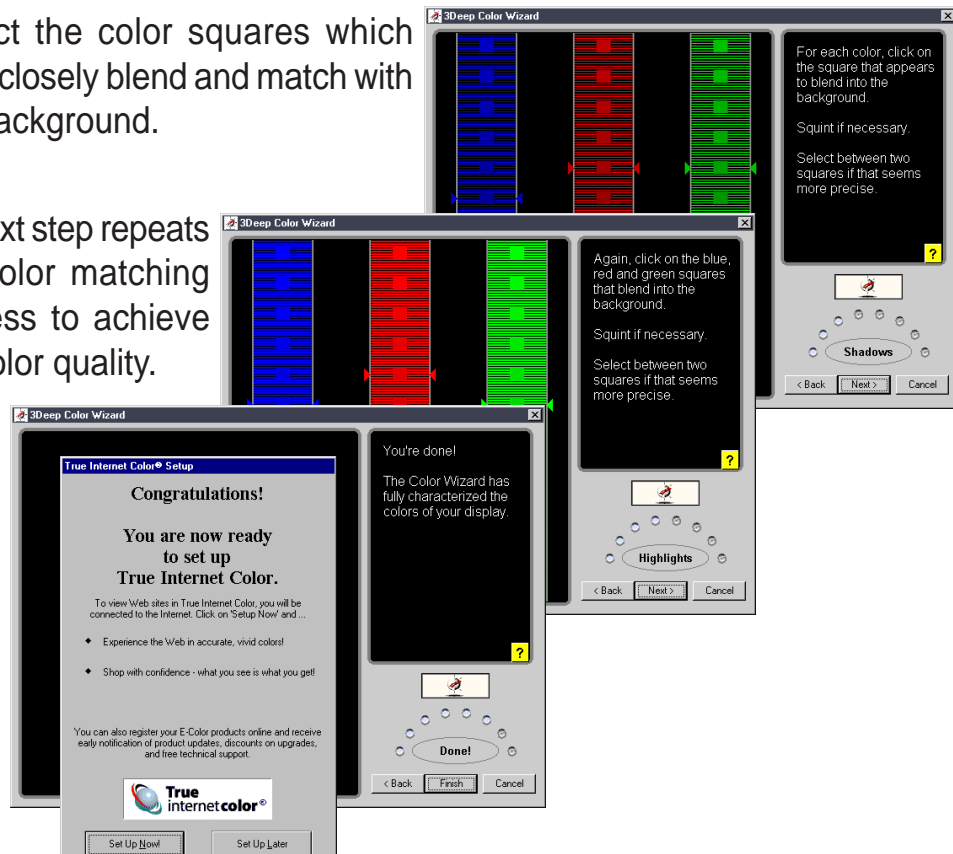

6. The tuning process is complete. Click on the bottom left button to connect to the internet and follow the instructions.

5.6.2 The 3Deep Control Panel

Using the Windows **Start** button, activate the **3Deep Control Panel** program from the **3Deep Applications** group on the **Main Program** menu. The control panel offers access to the **Color Wizard** tuning program, a **Game Gamma** setting and a **Tweak** slider for brightness adjustment.

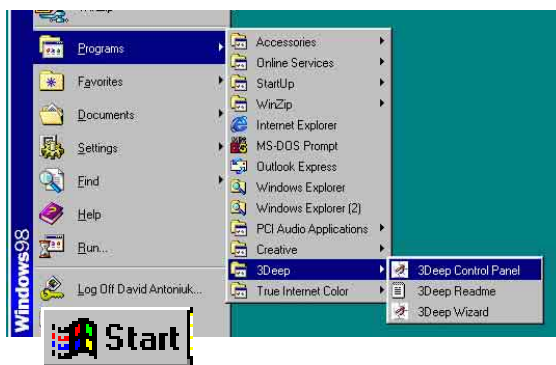

5.7 NVIDIA nForce Control Panel

The *nVidia nForce Control Panel* is a suite of five convenient applications to help you get the most from all your computer controlled audio systems.

After installing the *nVIDIA® nForce Driver*, look for an *nVIDIA® nForce APU icon* on the taskbar status area. Double-clicking the icon



opens the *NV nForce Control Panel*, a set of tools for you to set audio-related configuration.

5.7.1 Main

The *Main* page includes the primary sliders for adjusting the volume of all sound sources, recording input levels, equalization settings (and presets), as well as a signal meter to visually verify that sound is being produced.

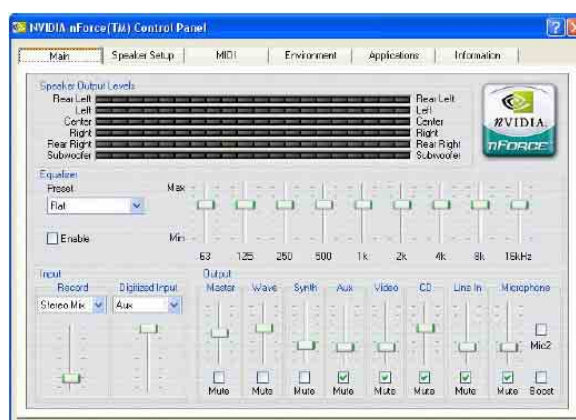

5.7.2 Speaker Setup

The *Speaker Setup* page is where you go to configure and setup your hardware. This page helps identify how the speakers are connected to the audio device, as well as what format to use when sending audio signals out of the PC. Here the number of speakers can be applied, the type of connection (digital or analog), individual volume levels for each speaker (balancing), and a host of specialty features. A wizard is also available to help guide the user through the process.

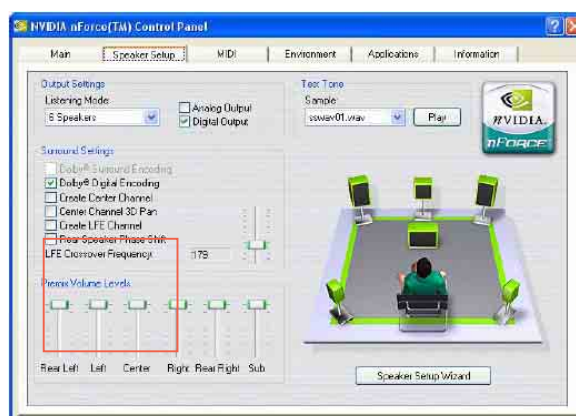

Click the **Speaker Setup Wizard** to setup audio output.

If you only have 3 audio jacks, it is recommended to use the Speaker Setup Wizard to switch the output from *Line_In* jack to *Rear Speaker Out* and the output from *Mic_In* jack to *Center Speaker Out, Subwoofer (Center/LFE output)*. If your back panel I/O have 5 audio jacks, refer to Chapter 2.8 “Audio Connectors” for details. No need to use **Speaker Setup Wizard** to switch audio jack outputs.

Connector Settings and Functions

(audio jack switching for motherboards with 3 audio jacks only)

Connector	Headphone/2 Speaker	4-Speaker	6-Speaker
Lime	Line Out/ Front Speaker Out	Line Out/ Front Speaker Out	Line Out/ Front Speaker Out
Light Blue	Line In	Rear Speaker Out	Rear Speaker Out
Pink	Mic In	Mic In	Center Speaker Out, Sub-woofer

Here are some of the features on the Speaker Setup:

- **Dolby® Surround Encoding** - enables audio to be encoded for playback on home theater receivers (using analog stereo outputs only)
- **Dolby® Digital Encoding** - Enables audio to be encoded for playback on 5.1 home theater receivers (using digital SPDIF output only)

This optional S/PDIF audio module allows digital instead of analog sound input and output.

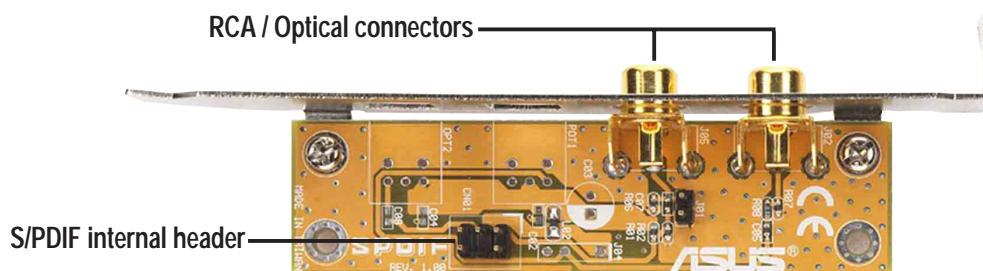

IMPORTANT! For S/PDIF out function, you may use either the module or the S/PDIF connector (optional) at the back panel, but not both.

- **Create Center Channel** - Generates a center channel for audio content that does not have it natively (like MP3s, WMAS, etc.)
- **Create Channel 3D Pan** - Allows game sounds to be panned through the center speaker when they pass between the left and right speakers (only works for DirectSound3D games)
- **Create LFE Channel** - Generates a subwoofer signal for speaker systems that require it (like Dolby Digital receivers or home theaters with discreet subwoofer inputs)
- **Rear Speaker Phase Shift** - Adjusts the output of the rear speakers so that sounds don't 'cancel out' and remove the bass channel or cause a 'tinny' sound (primarily older 4 channel PC speaker systems)
- **LFE Crossover Frequency** - Adjusts the amount of bass signal removed from the main speakers and sent specifically to the subwoofer output (increment in hertz).

5.7.3 MIDI

This tab allows you to change settings to MIDI playback. A MIDI song can be tested at the **Audition** section using all available effects or just the highted effect. The **Download Sounds** section allows the loading and unloading of DLS or SoundFont sample banks from system memory. These banks provide the instrument sounds for any MIDI files played on the system. Finally, at the bottom we have the effects panel. Since this panel is very similar to the Environment tab.

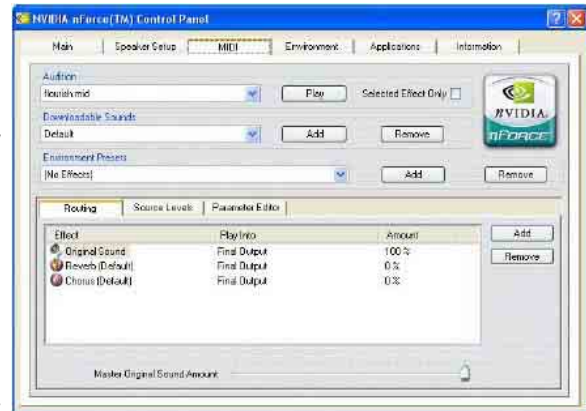

5.7.4 Environment

The **Environment** page is the most powerful section of the application. Like the **MIDI** page, a song or WAV fiel can be tested, and an environment can be applied using a preset at the **Environment Presets** drop down box. The power comes in the next section where you have the ability to add or remove effects to construct and environment of our own liking.

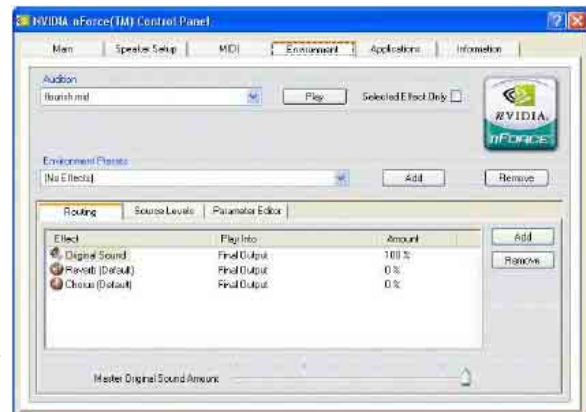

5.7.5 Applications

The **Applications** page is used to put audio application shortcuts. It is just a quick way to get at their favorite audio applications from within the Control Panel. Applications can be added or removed by using the buttons in the lower right hand corner of this page.

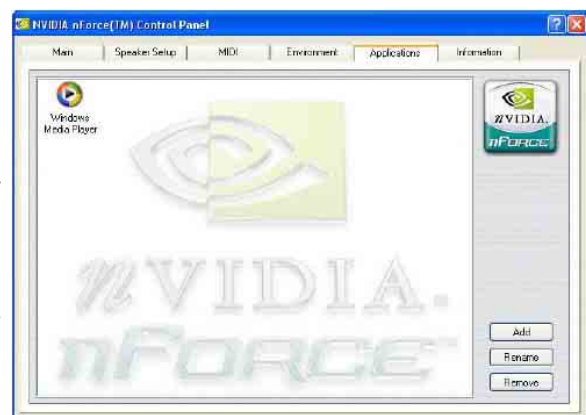

5.7.6 Information

The **Information** page shows the details of the APU (optional), hardware and software revisions, driver revisions, current DirectX version, and in “Advanced” mode the DSP and voice utilization. This is the first place to look when you are verifying what drivers you are running and the last place to look when you want to know what is going on at the lower levels of the APU.



5.7.7 Troubleshooting Q & A :

1. **How can I get 5.1 channels audio?**

- You must have a 5.1 speaker system.
- The audio source must be 5.1 channel soundtracks.
- Click Speaker Setup Wizard in the Speaker Setup tab of NVIDIA nForce Control Panel to setup your 5.1 audio channel.

2. **Why I can't hear 5.1 channels audio when playing a CD or MP3 file?**

Because the audio source is a two channel audio.

3. **Is "S/PDIF" equal to "Dolby Digital"?**

S/PDIF (Sony®/Philips® Digital Interface) is a digital audio transfer standard. It defines the physical layer for the transmission media interface and the data format. Audio or non-audio data can transmit by S/PDIF. But only the audio data encoded in *Dolby® Digital* format is *Dolby® Digital 5.1* audio developed in the *Dolby® Lab*.

4. **Can I get Dolby® Digital audio from Analog out?**

It depends on the audio source. If the audio source is stored in *Dolby® Digital* audio format, and you have a *Dolby® Digital Software decoder*, then *Dolby® Digital* audio is possible from the *Analog out* source.

5.7.8 Audio Glossary

Dolby® Surround is an audio encoding process. When a *Dolby® Surround* soundtrack is produced, four channels of audio information — *left*, *center*, *right*, and *surround*— are matrix-encoded onto two audio tracks. These two tracks are then recorded onto stereo program sources, like videotapes and TV broadcasts.

Dolby® Digital 5:1 (AC-3) is an audio encoding process that simulates the illusion of *total surround sound*. The system consists of five speakers and one bass unit, hence the name 5:1. Normally, the listener is faced by two front speakers and surrounded by two rear speakers; both pair of speakers supply full stereo output. An additional, center speaker, facing the listener, is mainly used for dialogue between actors and actresses.

The *Dolby® Digital 5:1 AC-3* coder is designed to take advantage of natural human auditory masking. *AC-3 coding* is essentially a very selective and powerful noise reduction filter. The coder system divides the audio spectrum of each channel into narrow frequency bands of precise proportions, each one optimized with respect to the innate frequency selectivity of human hearing. Coding noise is filtered out by matching its frequency to the “blind spots” of human hearing. By reducing coding noise, the sound quality of the original signal can be preserved and enhanced.

S/PDIF: S/PDIF (Sony/Philips Digital Interface) is a standard audio transfer file format. It is usually built-in to the digital processors of audio equipment such as DAT recorders or audio processing devices. It facilitates transfer of audio data from one file to another without conversion to and from the analog format, which could degrade signal quality. The most common connector used with an S/PDIF interface is the RCA jack, the same one used for many consumer audio-visual products. An optical connector is also available.

5.8 Winbond Voice Editor (optional)

The Winbond Voice Editor software allows you to customize the vocal POST messages. Install the software from the software menu in the support CD.



IMPORTANT! To avoid conflicts, do not run the Winbond Voice Editor while running the ASUS PC Probe.

Follow these steps to use the Winbond Voice Editor.

Launching the program

Launch the program either from the Winbond Voice Editor icon on your desktop, or from the Windows Start menu, **Programs/Winbond Voice Editor/Voice Editor**.

The Winbond Voice Editor screen appears.

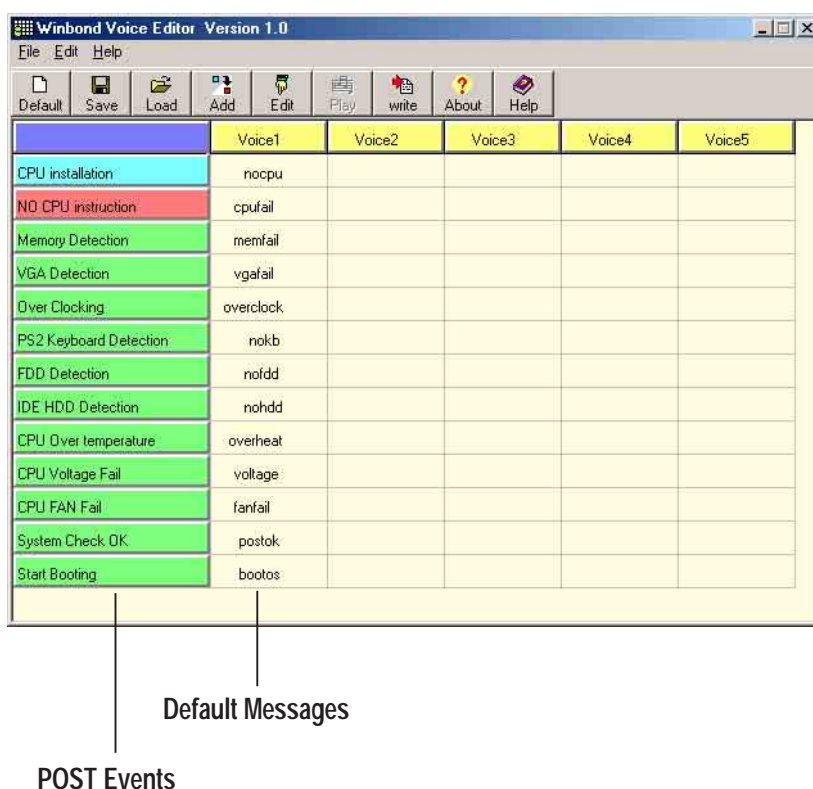

Playing the default wave files

To play the default wave files, simply click on a POST event on the left side of the screen, then click the Play button.



NOTE: The default language setting is English.

Changing the default language

1. Click on the Load button. a window showing the available languages appears.
2. Select your desired language then click Open. The event messages for the language you selected appear on the Voice Editor screen.



NOTE: For some languages, not all events have a corresponding message due to file size constraints.

3. Click on the Write button to update the EEPROM.
4. Click Yes on the confirmation window that appears.



The next time you boot your computer, the POST messages are announced in the language that you selected .

5.9 RAID 0/RAID 1 configurations

The motherboard includes the Silicon Image Sil 3112A controller chipset and two Serial ATA interfaces to support Redundant Array of Independent Disks (RAID) configuration. This feature supports Serial ATA hard disks. Use the SATAraid™ utility to configure the RAID sets.

RAID 0 (called *data striping*) optimizes two identical hard disk drives to read and write data in parallel, interleaved stacks. Two hard disks perform the same work as a single drive but at a sustained data transfer rate, double that of a single disk alone, thus improving data access and storage.

RAID 1 (called *data mirroring*) copies and maintains an identical image of data from one drive to a second drive. If one drive fails, the disk array management software directs all applications to the surviving drive as it contains a complete copy of the data in the other drive. This RAID configuration provides data protection and increases fault tolerance to the entire system.

5.9.1 Install the hard disks

The Sil 3112A chipset supports Serial ATA hard disk drives. For optimal performance, install identical drives of the same model and capacity when creating RAID sets.

- If you are creating a **RAID 0 (striping)** array for performance, use two new drives.
- If you are creating a **RAID 1 (mirroring)** array for protection, you can use two new drives or use an existing drive and a new drive (the new drive must be of the same size or larger than the existing drive). If you use two drives with different sizes, the smaller capacity hard disk will be the base storage size. For example, hard disk A with an 80 GB storage capacity and hard disk B with 60 GB storage capacity, the maximum storage capacity for your RAID 1 set will be 60 GB.

Follow these steps to install the hard disks for RAID configuration.

1. Install the Serial ATA hard disks into the drive bays.
2. Connect one Serial ATA HDD to each Serial ATA connector, using separate serial ATA cables.
4. Connect the power cable to the power connector on each drive.
5. Make sure that the Serial ATA jumpers are set to enabled. See “2.7 Jumpers, Serial ATA Setting (3-pin SATA_EN1)” for more detailed information on jumper settings.
6. Proceed to 5.9.2 for the next procedure.

5.9.2 Creating and Deleting RAID sets

Creating and deleting RAID sets is a built-in function found in the BIOS. The following sub-sections describes how to use the RAID Configuration Utility.

5.9.2.1 Loading the RAID Configuration Utility

During POST, press <CTRL+S> or F4 to enter RAID configuration utility. The following menu options will appear.

```
Create RAID Set
Delete RAID Set
Rebuild RAID Set
Resolve Conflicts
```

Below this menu items are the listed drives installed on the system. The top right half of the screen displays the directions and comments for the user. The bottom right half lists the command keys.

```
↑↓      Select Menu
ESC     Previous Menu
Enter   Select
Ctrl-E  Exit
```

5.9.2.2 Creating RAID Sets

1. Select “Create RAID Set”
2. Choose either a “Striped” or “Mirrored” RAID Set.
3. Select if you want the utility to Auto Configure the RAID Set or if you want to manually configure the RAID set. For Striped Sets, you can change the chunk size. For Mirrored Sets, you assign which is the Source and Target drives, as well as if you want a Disk Copy.



-
- *What is a chunk?* The chunk size is the “stripe” on each disk. It is the unit of storage equivalent to one stripe on a RAID 0 set. Available chunk sizes: [2] [4] [8] [16] [32] [64] [128]
 - When manually setting the chunk size for your RAID set, it is recommended to use the smaller chunk size for server applications and the larger chunk size for AV applications.
 - *What is Disk Copy?* If the disk assigned as the source disk has been partitioned and has data stored on it, and a second disk is added, the data on the source drive can be copied to the destination drive, so the disks are identical, and all subsequent data will be written to both drives as a Mirrored set. If, however, the source disk does not have data stored on it, there is no need for Disk Copy.
-

4. The utility will ask “Are You Sure? (Y/N)” before completing the configuration. Press “Y” to confirm or “N” to go back to the configuration options.

5.9.2.3 Deleting RAID Sets

1. To remove one or more RAID sets, select “**Delete RAID Set**”
2. Select desired set and press “Y” when asked “Are You Sure? (Y/N)”

5.9.2.4 Resolving Conflict

When a RAID set is created, the metadata written to the disk includes drive connection information (Primary Chanel, Secondary Chanel). If, after a disk failure, the replacement disk was previously part of a RAID set (or used in another system), it may have conflicting metadata, specifically in reference to the drive connection information. If so, this will prohibit the RAID set from being either created or rebuilt. In order for the RAID set to function properly, this old metadata must be first overwritten with the new metadata. To resolve this, select “**Resolve Conflict**” and the correct metadata, including the correct drive connection information, will be written to the replacement disk.

Chapter 6

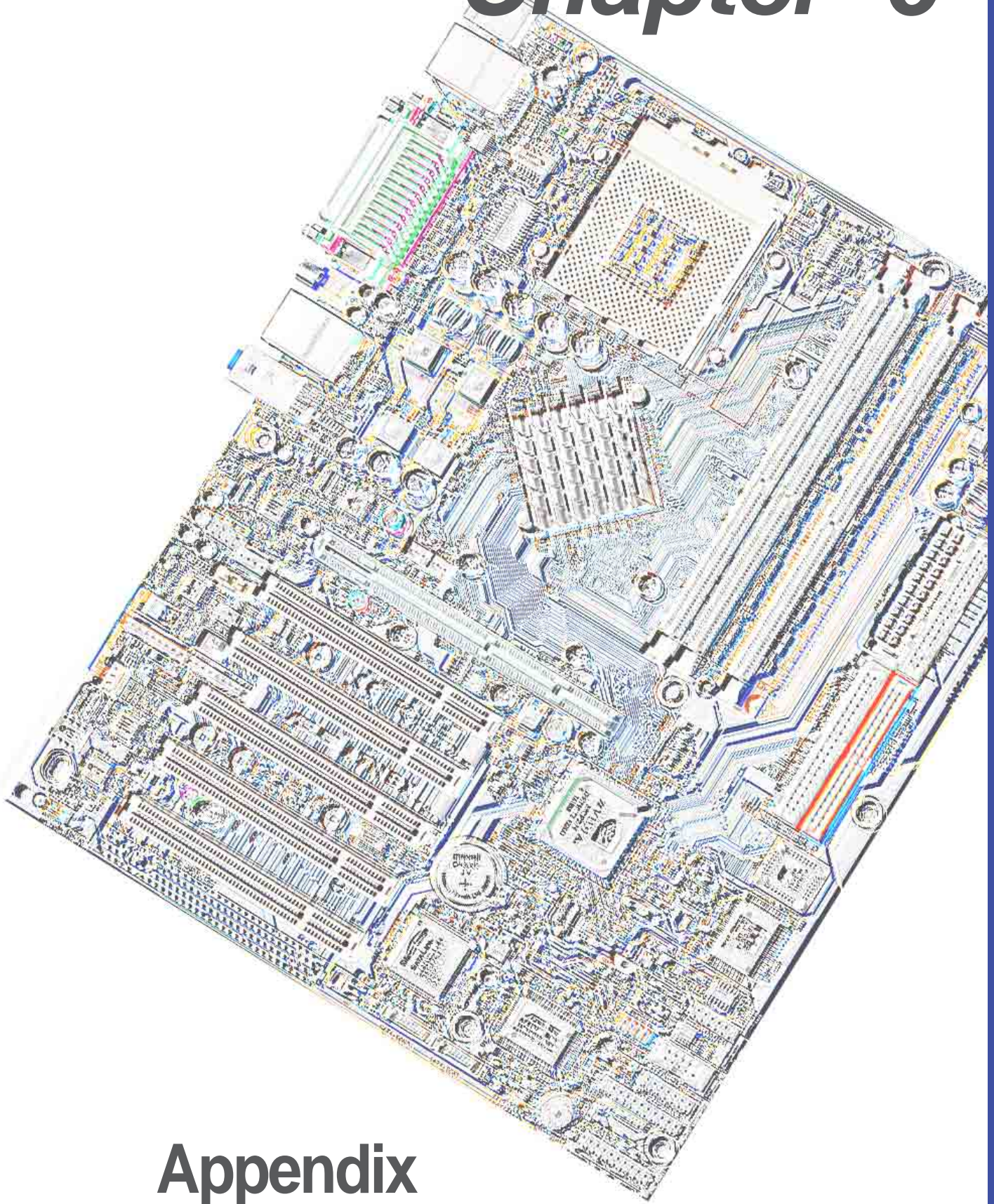

Appendix

6.1 Glossary

1394

1394 is the IEEE designation for a high performance serial bus that offers data transfers at 100/200/400 Mbps. This serial bus defines both a back plane physical layer and a point-to-point cable-connected virtual bus. The primary application of the cable version is the integration of I/O connectivity at the back panel of personal computers using a low-cost, scalable, high-speed serial interface. The 1394 standard also provides new services such as live connect/disconnect capability for external devices including disk drives, printers and hand-held peripherals such as scanners and cameras. This is a new standard to complement the slower USB interface and to compete with the more expensive SCSI interface.

AC97 (Audio Codec '97)

AC '97 is the next step in enabling PCs with audio quality comparable to consumer electronics devices. The specification defines new cost-effective options to help integrate the components necessary to support next-generation audio-intensive PC applications such as DVD, 3-D multiplayer gaming and interactive music. The specification also defines new extensions supporting modem and docking to help both desktop and mobile manufacturers adopt these new technologies more quickly and cost-effectively. This specification uses software emulation to compete with the PCI SoundBlaster specification.

ACPI (Advanced Configuration and Power Interface)

The ACPI specification defines a cross-platform interface designed to support many operating systems. ACPI defines a flexible and abstract hardware interface that provides a standard way to integrate power management features throughout a PC system, including hardware, operating system and application software. This enables the system to automatically turn ON and OFF peripherals such as CD-ROMs, network cards, hard disk drives, and printers, as well as consumer devices connected to the PC such as VCRs, TVs, phones, and stereos. With this technology, peripherals will also be able to activate the PC. For example, inserting a tape into a VCR can turn on the PC, which could then activate a large-screen TV and high-fidelity sound system.

AGP (Accelerated Graphics Port)

An interface specification that enables high-performance 3D graphics on mainstream PCs. AGP was designed to offer the necessary bandwidth and latency to perform texture mapping directly from system memory.

Bus	Bus Frequency	Data Transfer Rate
PCI	33MHz	133MByte/sec
AGP 1X	66MHz	266MByte/sec
AGP 2X	66MHz	512MByte/sec
AGP 4x	66MHz	1024MByte/sec
AGP 8X	66MHz	2048MByte/sec

Backup. A copy of a file, directory, or volume on a separate storage device from the original. This copy is for the purpose of data retrieval in case the original is accidentally erased, damaged, or destroyed.

BIOS (Basic Input/Output System)

BIOS is a set of routines that affect how the computer transfers data between computer components, such as memory, disks, and the display adapter. The BIOS instructions are built into the computer's read-only memory. BIOS parameters can be configured by the user through the BIOS Setup program. The BIOS can be updated using the provided utility to copy a new BIOS file into the EEPROM.

Bit (Binary Digit)

A bit is the basic unit of digital data used by the computer. A bit equals either: 0 or 1.

Boot

Boot means to start the computer operating system by loading it into system memory. When the manual instructs you to “boot” your system (or computer), it means to turn ON your computer. “Reboot” means to restart your computer. When using Windows 95 or later, selecting “Restart” from “Start | Shut Down...” will reboot your computer.

Bus Master IDE

PIO (Programmable I/O) IDE requires that the CPU be involved in IDE access and waiting for mechanical events. Bus master IDE transfers data to/from the memory without interrupting the CPU. Bus master IDE driver and bus master IDE hard disk drives are required to support bus master IDE mode.

Byte (Binary Term) One byte is a group of eight contiguous bits. A byte is used to represent a single alphanumeric character, punctuation mark, or other symbol.

Cache Memory. A type of RAM that allows a faster from the CPU than a regular RAM. The cache memory eliminates the CPU wait state. When the CPU reads data from the main memory, a copy of this data is stored in the cache memory. The next time the same address, the data is transferred from the cache memory instead of from the main memory.

CODEC (Compressor/Decompressor). A software component that translates video or audio between its uncompressed form and the compressed form in which it is stored.

COM Port

COM is a logical device name used by to designate the computer serial ports. Pointing devices, modems, and infrared modules can be connected to COM ports. Each COM port is configured to use a different IRQ and address assignment.

Concurrent PCI

Concurrent PCI maximizes system performance with simultaneous CPU, PCI and ISA bus activities. It includes multi-transaction timing, enhanced write performance, a passive release mechanism and support for PCI 2.1 compliant delayed transactions. Concurrent PCI provides increased bandwidth, reduced system latencies, improves video and audio performance, and improves processing of host based applications.

CPU (Central Processing Unit)

The CPU, sometimes called “Processor,” actually functions as the “brain” of the computer. It interprets and executes program commands and processes data stored in memory. Currently, there are socket 370 (for Pentium III FC-PGA and Celeron-PPGA), socket 7 (for Pentium, AMD, Cyrix, IBM), slot 1 (for Pentium II and III), slot 2 (for Xeon), and slot A (for AMD) processors.

Device Driver

A device driver is a special set of instructions that allows the computer’s operating system to communicate with devices such as VGA, audio, printer, or modem.

DOS (Disk Operating System)

DOS is the foundation on which all other programs and software applications operate, including Windows. DOS is responsible for allocating system resources such as memory, CPU time, disk space, and access to peripheral devices. For this reason, DOS constitutes the basic interface between you and your computer.

DRAM (Dynamic Random Access Memory)

A type of RAM that requires refresh cycles to prevent the loss of the data stored in it. There are several different types of DRAM such as, EDO DRAM (Extended Data Output DRAM), SDRAM (Synchronous DRAM), and RDRAM (Rambus DRAM) and DDR DRAM, (Double-Data Rate DRAM).

Flash ROM

non-volatile memory device that retains its data even when power is removed. This device is similar to EPROM, but unlike EPROM which can be erased only using an ultra-violet light, flash ROM can be electrically erased. Flash ROM is normally used for system BIOS, which initiates hardware devices and sets up necessary parameters for the OS. Since the flash ROM contents can be modified, users can easily update the BIOS..

IDE (Integrated Drive Electronics)

IDE devices integrate the drive control circuitry directly on the drive itself, eliminating the need for a separate adapter card (in the case for SCSI devices). UltraDMA/33 IDE devices can achieve up to 33MB/Sec transfer.

I/O (Input/Output)

The data transfers from the input devices like a keyboard, mouse, or scanner, to the output devices like a printer or the monitor screen.

I/O Address

The specific memory location for a particular device. Two devices cannot share the same I/O address space.

IrDA (Infrared Data Association)

An international organization that creates and promotes inter-operable, low cost, infrared data interconnection standards that support a walk-up, point-to-point model. The IrDA protocol is designed to support transmission of data between two devices over short-range point-to-point infrared at speeds between 9.6Kbps and 4Mbps.

ISP (Internet Service Provider)

A company that provides customer access to the Internet and the World Wide Web for a fee. The ISP also provides Internet utilities and services like e-mail, newsgroup, weather reports, and a host of others. The user can connect to the ISP using a modem installed in the computer and connected to a phone line.

LPT Port (Line Printer Port)

Logical device name reserved by DOS for the computer parallel ports. Each LPT port is configured to use a different IRQ and address assignment.

MMX

A set of 57 new instructions designed to accelerate multimedia and communications applications, such as 3D video, 3D sound, video conference.

Modem

A device that allows a computer to talk to another computer through the phone system.

Network

An interconnected computer system linked by telephone wires, or other means.

OnNow

The OnNow design initiative is a comprehensive, system-wide approach to system and device power control. OnNow is a term for PC that is always ON but appears OFF and responds immediately to user or other requests. The OnNow design initiative involves changes that will occur in the Microsoft Windows operating system, device drivers, hardware, and applications, and also relies on the changes defined in the Advanced Configuration and Power Interface (ACPI) specification.

PC100/133

This is an industry-standard designation for memory capacity as a measure of the speed of the memory bus. New platform requirements ensure that memory does not become a bottleneck to system performance.

PCI Bus (Peripheral Component Interconnect Local Bus)

PCI bus is a standard specification that defines a 32-bit data bus interface.

PCI Bus Master

The PCI Bus Master can perform data transfer without local CPU help and the CPU can be treated as one of the Bus Masters. PCI 2.1 supports concurrent PCI operation to allow the local CPU and bus master to work simultaneously.

POST (Power On Self Test)

Powering on the computer initiates the POST, a series of software-controlled diagnostic tests. The POST checks system memory, the motherboard circuitry, the display, the keyboard, the diskette drive, and other I/O devices.

PS/2 Port

PS/2 ports are based on IBM Micro Channel Architecture. This type of architecture transfers data through a 16-bit or 32-bit bus. A PS/2 mouse and/or keyboard may be used on ATX motherboards.

RDRAM (Rambus DRAM)

Developed by Rambus, Inc., this type of memory can deliver up to 1.6GB of data per second. RDRAM is the first interface standard that can be directly implemented on high performance VLSI components such as, CMOS DRAMs, memory controllers, and graphics/video ICs.

RAM (Random Access Memory). The computer's primary storage area used to write, store, and retrieve information and program instructions which are passed to the CPU for processing. The information in RAM can be repeatedly re-written with new data. Compared to other storage media like magnetic tape, floppy disk, and hard disk, RAM has an extraordinarily fast access rate. RAM, however, is volatile, which means that the data stored in it are lost when the system power is turned off, or if power glitches occur. See also DRAM and SDRAM.

ROM (Read Only Memory)

ROM is nonvolatile memory used to store permanent programs (called firmware) used in certain computer components. Flash ROM (or EEPROM) can be reprogrammed with new programs (or BIOS).

SCSI (Small Computer System Interface)

High speed multi-threaded I/O interface defined by the X3T9.2 committee of the American National Standards Institute (ANSI) for connecting many peripheral devices. The standard started from 10MBytes/sec to 160MBytes/sec available today.

SDRAM (Synchronous DRAM)

A type of DRAM with access signals that are synchronized with the CPU clock, eliminating the delay associated with data transfers between the CPU and memory. SDRAM takes memory access away from the CPU control; internal registers in the memory accept the request, and lets the CPU do something else while the data requested is assembled for the next time the CPU talks to the memory.

SPD for SDRAM module

Serial Presence Detect (SPD) is most like an ID detect for SDRAM module, it using a EEPROM component on DIMM module for storing module configuration information inside. The Serial Presence Detect function is implemented using a 2048 bit EEPROM component. This nonvolatile storage device contains data programmed by the DIMM manufacturer that identifies the module type and various SDRAM organization and timing parameters.

System Disk

A system disk contains the core file of an operating system that boots up the operating system.

TCP/IP (Transmission Control Protocol/Internet Protocol). The communications protocol used by the UNIX system and the Internet. TCP checks for lost packets, puts the data from multiple packets into the correct order, and requests that missing or damaged packets be resent.

USB (Universal Serial Bus)

A 4-pin serial cable bus that allows up to 127 plug and play computer peripherals such as keyboard, mouse, joystick, scanner, printer, modem, and monitor to share a bandwidth through a host scheduled token based protocol. This allows attaching or detaching while the host and other peripherals are in operation. Supports synchronous and asynchronous transfer types over the same set of wires up to 12Mbit/sec. USB 2.0 provides twice the transfer rate compared to USB 1.0 and competes with the 1394 standard.

Wake-On-LAN

Computer will automatically wake-up upon receiving a wake-up packet through a Network interface when it is under power soft-off, suspend or sleep mode.

Index

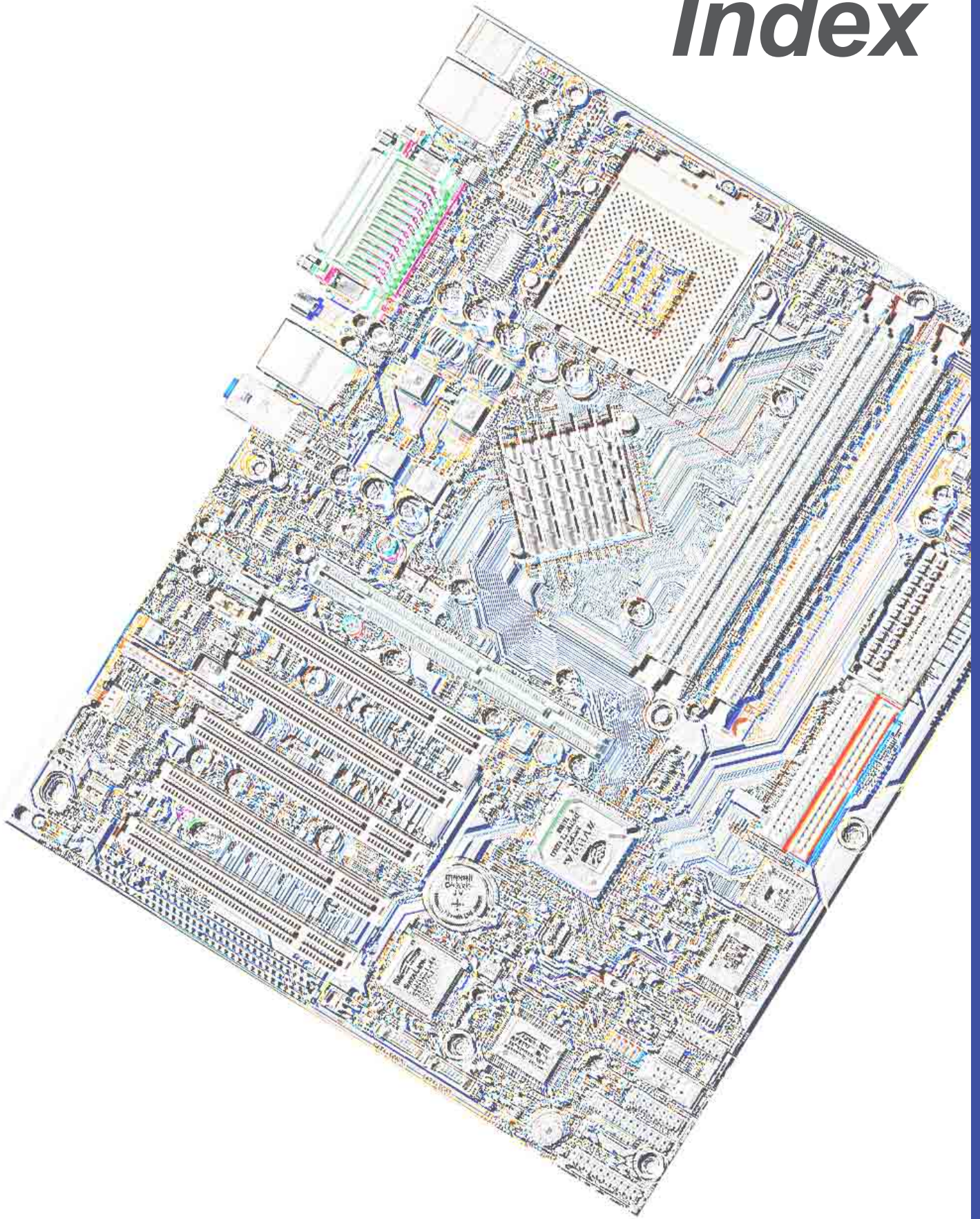

Index

Symbols

3Deep Color Tuner
Using 81

A

ASUS PC Probe
Using 75
ASUS Update
Using 80

B

BIOS
Advanced Menu 51
Beep Codes 35
Exit Menu 68
Legend Bar 44
Main Menu 46
Menu Bar 44
Power Menu 61
Setup Program 43
Sub-menu launching 45
Updating 40
BIOS Beep Codes 35

C

Central Processing Unit (CPU) 11
installation 12
Chip Configuration 55
Clear RTC RAM jumper 9, 21
Connectors
Audio 25
Chassis Fan 9, 28
CPU Fan 9, 28
Floppy Disk Drive 9, 10, 26
HDD LED 25
IDE 26

Internal Audio 9, 30
Panel 33
Parallel Port 24
PS/2 Keyboard 22
PS/2 Mouse 22
Serial Port 23
SMBus 29
USB 31

D

DIMM
installing 14

E

expansion card
installation 15
Expansion slots 15

F

Floppy Disk Drive Connector 9, 26

H

Hard Disk Drives (HDDs)
Cylinders 48
Heads 49
Primary Master/Slave 47
Secondary Master/Slave 50
Sectors 49

I

IDE Activity LED 25
IDE Connectors 26

J

Jumpers
Clear RTC RAM 9, 21
CPU FSB 21
Keyboard Wake Up 19

Serial ATA Setting 19
USB device wake-up 20

K

Keyboard
Connector 22
Keyboard Wake Up jumper 19

L

LiveUpdate 80
Using 80

M

Motherboard
IRQ Table 17
layout 8
placement 7
screws 7

Mouse
Connector 22

N

NVIDIA nForce Control Panel 83

O

Onboard LED 10
Operating system
installation 71

P

Parallel Port Connector 24
Password
Supervisor 64, 65
User 64, 65
PC Probe
Using 75
PCI Configuration 63
PS/2 Keyboard 22
PS/2 Keyboard Port 4
PS/2 Mouse 22
PS/2 Mouse Port 4

R

RTC RAM
Clearing 21

S

Serial Ports
Connectors 23
slots
AGP 18
PCI 17
SMBus Connector 29
Support CD 71
System Date 46
System memory
configurations 14
System Time 46

T

Troubleshooting 87

U

UART2 59
Universal Serial Bus (USB) 23
Ports 23
Using
3Deep Color Tuner 81
ASUS LiveUpdate 80
NVIDIA nForce Control Panel 83
PC Probe 75